



METALWORKS™ V-P500 ACOUSTIC BAFFLES

Inspiring Great Spaces™

Armstrong®

CEILING SYSTEMS

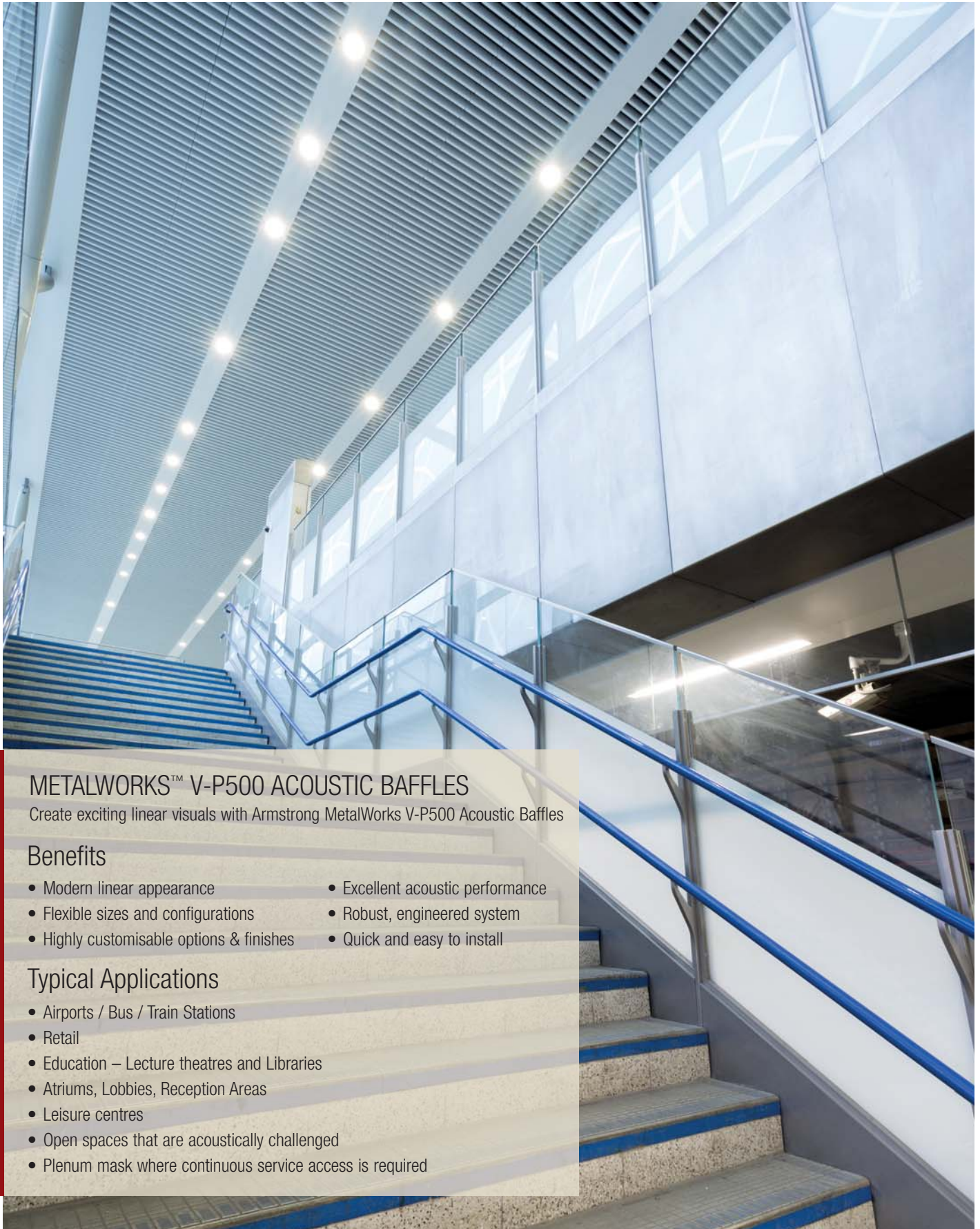

METALWORKS™ V-P500 ACOUSTIC BAFFLES

Create exciting linear visuals with Armstrong MetalWorks V-P500 Acoustic Baffles

Benefits

- Modern linear appearance
- Flexible sizes and configurations
- Highly customisable options & finishes
- Excellent acoustic performance
- Robust, engineered system
- Quick and easy to install

Typical Applications

- Airports / Bus / Train Stations
- Retail
- Education – Lecture theatres and Libraries
- Atriums, Lobbies, Reception Areas
- Leisure centres
- Open spaces that are acoustically challenged
- Plenum mask where continuous service access is required

Project: Paddington Station, London
Product: METALWORKS™ V-P500 Acoustic Baffles

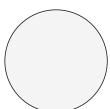

Pure White (WH)
RAL9003

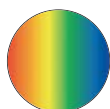

Custom colours
available

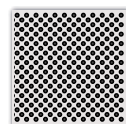

Micro Perforated
Hole diameter: 1.5mm
Open area: 22%

Due to printing limitations, shades may vary from actual product.

PHYSICAL DATA

Item	Dimensions (mm)	Pieces / carton	Weight
VP330W	H = 300 x L = 3000 x W = 30	2pcs/ctn	9.6kg/pc

Other Baffle sizes (depth and length) available on request.

- Material:** Galvanised steel (0.70mm guage)
- Perforations:** Both vertical sides Microperforated with approximately 12mm plain border. Other perforations available on request.
- Acoustical infill:** Glass wool acoustic pad 25mm, 25kg/m³ with black acoustic fleece on both sides.
- Surface Finish:** Powdercoated WH – Pure White (RAL9003). Customs colours available on request.
- Specification:** Armstrong METALWORKS™ V-P500 Acoustic Baffles Ceiling with concealed Unigridd™ Channel Suspension.

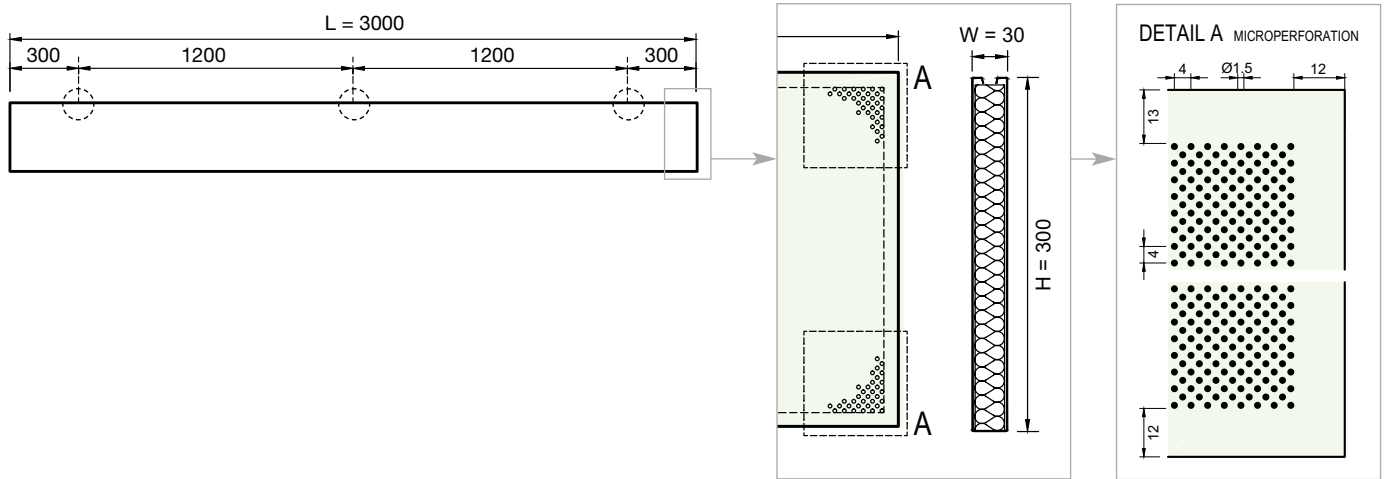

PERFORMANCE



METALWORKS™ V-P500 Acoustic Baffles can significantly reduce background noise levels and reverberation times within spaces and enhance speech intelligibility. They provide absorption on all surfaces of the product either as a 'planar' absorber (w), when installed as a linear array; or as a 'discrete' absorber when installed as separate decorative elements.

Acoustical Data – 1000mm airspace

Perforation – Dimensions (mm)	EAA – Sabines*
● Microperforated 300 x 1800	0.73

* Average of 500-4000Hz, laboratory measurements with units suspended at 1000 mm, in accordance with EN ISO 354:2003. Contact the Armstrong Technical Sales team for further acoustic and performance information.

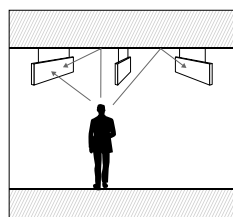

Discrete absorption

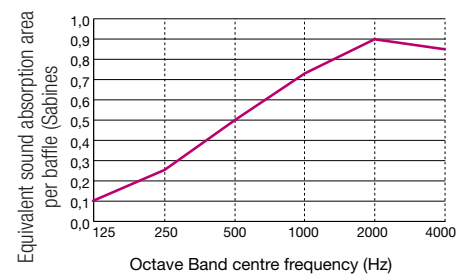

Acoustical Data – 600mm total depth (300mm Void)

Perforation – Dimensions (mm)	Spacing centre (mm)	α_w
● Microperforated 300 x 1800	300	0.55(H)

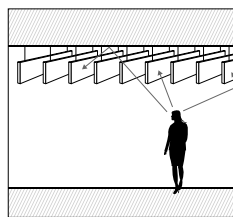

Planar absorption

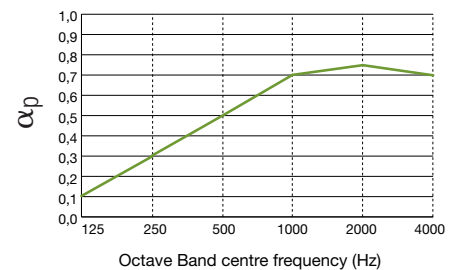

Conforms with BCA Spec. C1.10 and tested to AS/NZS 3837:1998 – Group 1, ISO 5660 – Group 1-S



Humidity Resistance RH99%



Recycled Content ≤ 30%



Light Reflectance 65%

SUSPENSION SYSTEM AND ACCESSORIES

Item	Description
UNI111B	Unigrig™ Channel (3750mm)
UNI103B	Unigrig™ Channel Connector
BPM300367	Baffle Hanger
BPM300371	Baffle Connector
BPM311044	Baffle Distance Holder
BPM300375	Baffle End Cap
UNI203B	Suspension Clip for 5mm Rod
UNITRCB	Suspension Clip for M6 Threaded Rod
ROD 5mm	5mm Suspension Rod
UNI200	Locking Clip
UNI202	Unigrig™ Wall Anchor Bracket

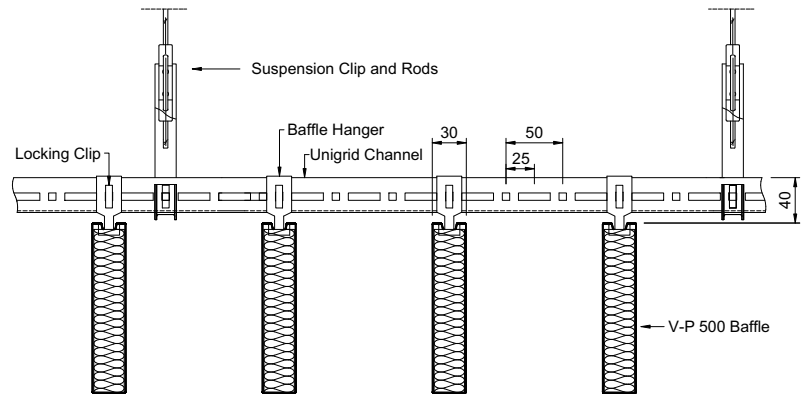

Refer to METALWORKS V-P500 Installation Guide for more information.

CONTACT

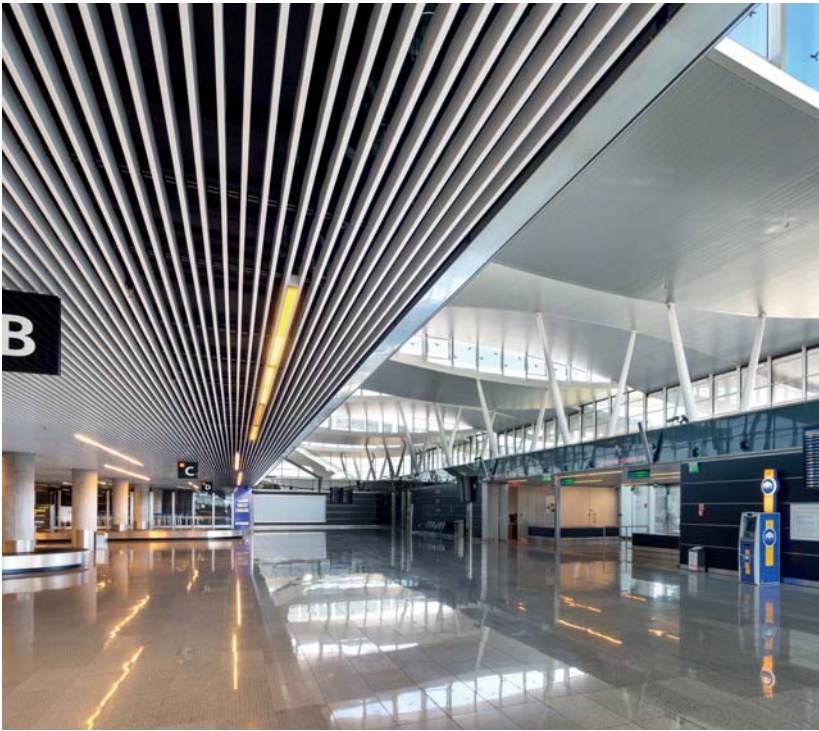

METALWORKS V-P500 Acoustic Baffles in White
PL Airport Lotniczy Wroclaw



SCAN* THIS CODE to learn more about our METALWORKS V-P500 Acoustic Baffles

*Download a Free QR code reader app available from Apple store

Armstrong World Industries Pty Ltd

NSW

Armstrong World Industries Pty. Ltd.
99 Derby Street, Silverwater NSW 2128
Telephone (02) 9748 1588 | Facsimile (02) 9748 8449

VIC/TAS

Armstrong World Industries Pty. Ltd.
Unit 1, 88 Henderson Road, Rowville VIC 3187
Telephone (03) 8706 4000 | Facsimile (03) 8706 4040

QLD/NT

Armstrong World Industries Pty. Ltd.
6 Barrinia Street, Slacks Creek QLD 4127
Telephone (07) 3809 5565 | Facsimile (07) 3809 5507

SA

Total Building Systems Pty. Ltd.
160 Grand Junction Road, Blair Athol SA 5084
Telephone (08) 7325 7555 | Facsimile (08) 7325 7566

WA

Ceiling Manufacturers of Australia Pty. Ltd.
5 Irvine Street, Bayswater WA 6053
Telephone (08) 9271 0777 | Facsimile (08) 9272 2801

New Zealand

Forman Building Systems Ltd.
PO Box 12349, Penrose, Auckland
Telephone 64-9-276 4000 | Facsimile 64-9-276 414

www.armstrongceilings.com.au