

# Promat

## PROMATECT® 100 Passive Fire Protection Building & Construction Solutions



[www.promat.com](http://www.promat.com)

Solely for distribution in Australia



## Partitions



Steel stud partition type	Fire resistance performance	STC	R <sub>w</sub>	Board layer and thickness	Typical system weight	Total partition thickness	Test/Approval no.	Page no.
 <p>PROMATECT® 100 single steel stud partition (double sided)</p>	-/90/60	Up to 50dB	Up to 50dB	1 x 15mm (each side)	* From 27kg/m <sup>2</sup>	From 94mm	BRE P106900-1005 AS 1530: Part 4: 2014	80
	-/120/120	Up to 48dB	Up to 50dB	1 x 20mm (each side)	* From 35kg/m <sup>2</sup>	From 104mm	WFRA45883 AS 1530: Part 4: 2014	81
	120/120/120	Up to 48dB	Up to 50dB					
 <p>PROMATECT® 100 single steel stud partition (double sided)</p>	-/240/240	Up to 55dB	Up to 59dB	2 x 20mm (each side)	* From 70kg/m <sup>2</sup>	From 164mm	BRE P106900-1005 to the requirements of AS 1530: Part 4: 2014	87
 <p>PROMATECT® 100 double steel stud partition (double sided)</p>	-/120/120	Up to 57dB	Up to 60dB	1 x 20mm (each side)	* From 36kg/m <sup>2</sup>	From 178mm	WFRA 45883 to the requirements of AS 1530: Part 4: 2014	95
 <p>PROMATECT® 100 timber stud partition</p>	-/90/90	Up to 35dB	Up to 39dB	1 x 20mm (each side)	* From 37kg/m <sup>2</sup>	From 130mm	BRANZ FR6112 AS 1530: Part 4: 2014	99
	90/90/90	Up to 35dB	Up to 39dB					
 <p>PROMATECT® 100 solid/frameless internal partition</p>	-/120/120	Up to 36dB	Up to 36dB	2 x 20mm	* From 34kg/m <sup>2</sup>	40mm	BRANZ FAR3309 AS 1530: Part 4: 2005	103

\* For partitions up to 3000mm. Stud sizes may increase for partitions above 3000mm of height. Please consult Promat.



### Introduction

Partitions are used to separate buildings, enclose compartments and contain fire by providing a barrier to the passage of fire from one side or the other, or both. In doing so, they are able to satisfy each of the relevant fire resistant criteria (integrity, insulation and, if the wall is loadbearing, load bearing capacity) from either side for the prescribed period.

The application of partition and external wall systems using Promat boards covers both non loadbearing and loadbearing in commercial, industrial, institutional, residential and high rise constructions, or in the restoration of existing buildings. Promat's internal partition systems require less material to achieve similar fire resistant level when compared to industry average wallboard partition systems. The single layer board application leads to simplified construction methods over other equivalents and in turn to increased productivity and reduced overall installation cost.

These partition and external wall systems have been developed by Promat International (Asia Pacific) Ltd to satisfy standard requirements for intended applications. Such considerations include:

#### Time & cost effectiveness

Single layer application reduces installation cost and time compared to traditional wallboard constructions.

#### Slim walls

Partitions can be as thin as 35mm.

#### Lightweight

Lighter loads on structures compared to industry average wallboard partition systems for equivalent fire resistance.

#### Thermal resistance

Excellent thermal resistance performance. **Impact resistant** PROMATECT®-H partition systems have been tested for resistance to impact, stiffness and robustness in accordance with the criteria of BS 5234: Part 2.

#### Acoustic performance

Tested and assessed to a range of standards, including ISO 140-3: 1995, ISO 717-1: 1996, AS 1191: 2002, AS/NZS 1276: Part 1, BS 5821: 1984 and BS 2750: Part 3: 1980, to meet the needs of industry. Please refer to [pages 64 to 66](#) for details.

### Fire resistance performance

Promat partitions and external wall systems have been extensively tested and assessed in accordance with BS 476: Parts 21 and 22 and AS 1530: Part 4 to satisfy the integrity, insulation and where applicable loadbearing capacity (structural adequacy) criteria.

### General design considerations for partitions

Following are some of the factors to take into account when determining correct specifications that ensure a partition provides required design performance under both fire and ambient conditions.

#### Studwork design

The design of studwork should be adequate for the height of the partition. The studwork details given in the following specifications are suitable up to the maximum heights stated. For greater heights the dimension of the framing members could change depending upon factors such as movement and deflection, and local approvals. Larger or more frequent frame sections will often improve fire and structural performance.

The studwork shall be appropriately designed for the applied loads, e.g. wind load, and where applicable structural load in the case of load bearing systems. The framing for the partition systems must be securely fixed back to a substrate that has an equal or greater fire performance than the designed partition. All fixings must be non combustible and must be those listed in the approval documents. The design shall be in accordance with the relevant British, Australian and/or International Standards.

#### Non loadbearing partitions

Non loadbearing partitions and external wall systems using Promat boards can be generally categorised as framing systems consisting of steel or timber studs and solid partitions. For steel stud systems, selection of suitable stud size shall be in accordance with the maximum partition height given in the stud selection tables. The partition systems in the following pages, where stated, are designed for lateral loads of up to 0.25kPa using the composite action of the frame and boarding.

---

### Loadbearing partitions

---

Loadbearing capacity of featured partition systems in this handbook are calculated in accordance with AS 4600: 2018 for load cases defined by AS 1170: 2002. The maximum load bearing capacity is given in kN for a given partition height taking into account the reduction in steel strength at elevated temperature.

Studs are located at 600mm maximum centres with noggings. Loads considered in this manual are for axial compression only. Wind and other loads have not been taken into consideration. For further information on these loads, please consult Promat.

---

### Deflection

---

Where differential movement is expected between the floor or beam above the construction and/or the floor below, it is generally advisable to incorporate a deflection head track to ensure undue stress is not placed upon the partition. This also allows for the sagging and deflection of a floor or structural beam will be subjected to under fire conditions. Even concrete floors will suffer considerable deflection under fire if exposed for any extended duration.

Some form of movement joint is also required to allow for the expansion of the studs under fire conditions. A partition will also bow at its centre. As the wall bows, it naturally becomes shorter. For this reason alone, use should be made of a top track with long side legs. This will allow the stud to bow and as a result drop down, without the studs dropping out of the head track.

---

### Movement joint

---

Movement stress from dimensional changes due to varying temperature or moisture conditions can cause cracking and other symptoms of distress in partitions. Other external forces such as impact or vibration can directly affect the structural movement of partitions. This movement can be controlled through a variety of design techniques such as introducing perimeter relief and slip connections to reduce the transfer of stress from the structure to other building sub elements and/or through the use of expansion joints, control joints and construction joints.

In a partition, expansion joints are needed when the partition abuts a rigid mass. A vertical movement joint should be located at maximum 10000mm centres in long runs of partition. However, introducing a control joint into a fire resistant partition creates an opening for flame and temperature transmission. Such openings must also be treated with approved fire stopping systems.

Please refer to [page 71](#) for further details on movement joints.

---

### Caulking & service penetrations

---

To maintain fire and where applicable acoustic performance of the partition system, gaps at the perimeter must be appropriately filled with suitable caulking material. PROMASEAL®-A Acrylic Sealant or other tested fire and acoustic resistant material of equivalent or better performance must be used.

Care needs to be taken in detailing a suitable fire stopping system around any penetration of the partition by services to ensure that the fire-stopping material remains in situ, and fire and smoke do not penetrate the partition.

Allowance should be made for thermal movement of the services in both ambient and fire conditions to ensure loads are not applied to the partition. Some examples of service penetrations include electrical cables, conduits or wires, switches and power outlets, plastic and metal pipes, air conditioning and ventilation ductwork. Further guidance on the penetration seals of these elements can be obtained on the PENETRATION SEALS section this handbook.

---

### Fire doors & glazing

---

Tested or assessed door and/or glazed assemblies should always be used. All and any doors or glazed elements with a fire resistant wall should be shown, by fully compliant testing to the appropriate standard, to be capable of providing at least an equal fire performance to the wall itself. This means fire doors should be tested in lightweight partition systems, not just in masonry. In most cases additional framework will be required to prevent loads being applied to the partition. Careful detailing is needed around the perimeter of any door or glazed assembly. Further guidance on the detailing at fire doors and glazing is available on [page 72](#).

---

### Partition junction

---

Care must be taken to ensure that partition corner junctions and intersections are stable for both fire and ambient conditions. Framing at these locations must be mechanically fastened together. Further information on the detailing these junctions can be found on [page 67](#).

---

### Board fixing

---

Promat boards can be installed horizontally or vertically.

For steel stud partition system, joints in the boards must be staggered between either side of the framing with all the joints located at a framing member. The boards may be fixed to the studs using No.8 bugle head self-drilling and self-tapping screws of a length appropriate for the board thickness. Needle point screws are normally used to fix boards to light gauge steel frames up to 0.8mm. Drill point screws are generally appropriate for heavy gauge steel frames from 0.8mm to 2.0mm.

When a timber frame is used, Promat boards are fixed to the framework using screws or nails of a length appropriate for the board thickness and the required fire resistance performance at nominal 300mm centres and minimum 12mm from the board edge. Minimum edge distance to fasteners and the maximum spacing between screws or nails must be maintained.

Internal and external corners may be set using a perforated metal corner bead fixed to the board linings at not more than 500mm centres.

### Steel frame components

#### Components selection

Construction of Promat fire resistant steel stud partitions can be achieved using stud and track components. Other steel components of equivalent performance can of course be used but it is the responsibility of the manufacturer of the component to substantiate equivalent performance with the recommended component.

#### Deflection head & bottom tracks

The main function of the ceiling and floor tracks is to hold the studs in position until the board is fitted. They provide a friction fit for the studs and also act as a slip joint to allow for any movement in the structure.

The track sections come in two basic profiles. A standard track has a nominal 32mm flange whilst the deflection head track has a nominal 50mm flange. However, head tracks with wider flange are available but they have to be specially designed for instances where clearance for expansion at the head track exceeds 20mm.

No clearance for expansion is applicable at the head track for a loadbearing partition. Track sections should be fixed at maximum 600mm intervals to the supporting structure. Fixings should be located not more than 100mm from either end of the track section.

#### Vertical studs

The recommended studs come in 0.50mm, 0.55mm, 0.75mm and 1.15mm. The 0.50mm to 0.75mm studs have standard 25mm bell-mouthed service holes for electrical cabling. For the 1.15mm stud, round holes are punched at designated centres along the stud.

Spliced extensions are possible in situations where the overall height of the partition is more than the stud length. The 0.50mm to 0.75mm studs may be boxed and the 1.15mm studs may be spliced back to back.

For greater rigidity at fire resistant glazing and door openings, and also at locations where extra load carrying capacity is required, studs of 0.50mm to 0.75mm may be boxed and studs of 1.15mm may be fixed back to back. See guide below on spliced studs and stiffening framing.

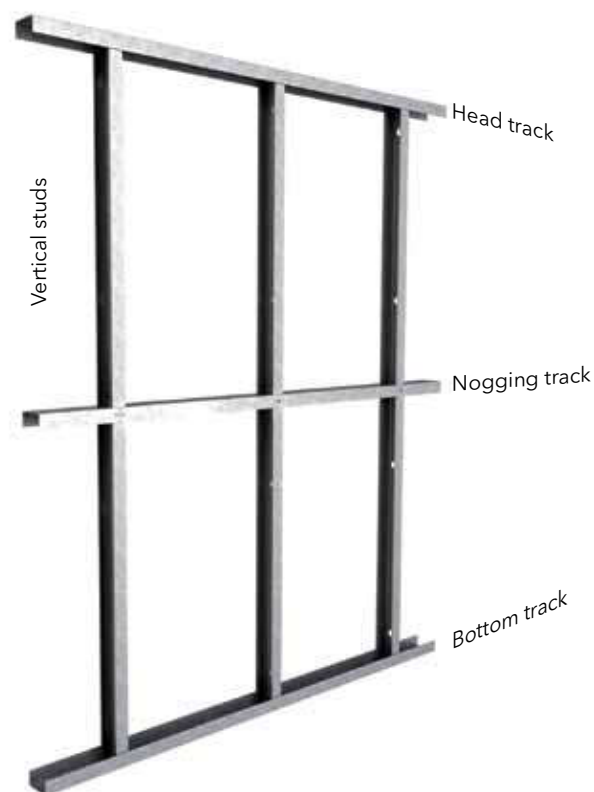

### Fixing of spliced vertical studs for partition heights up to 7000mm

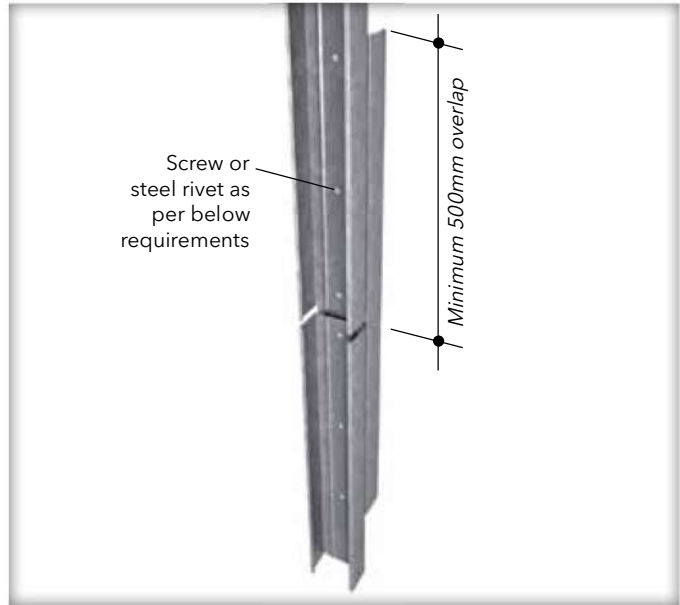
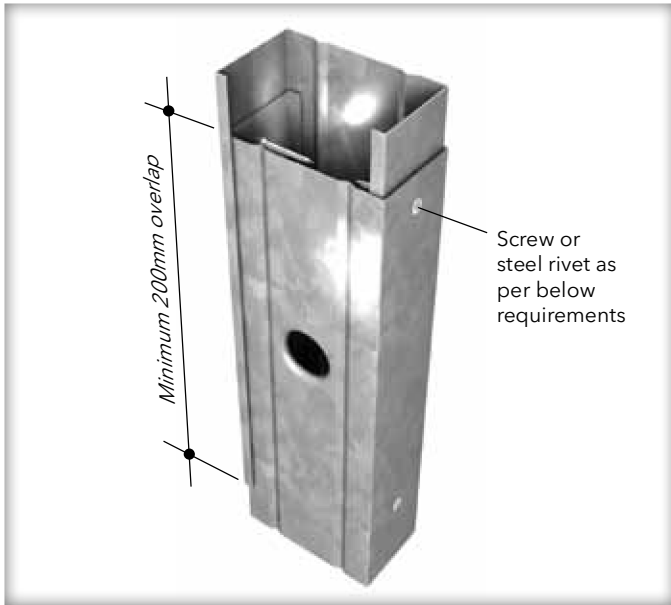

#### 1. 0.50/0.55/0.75mm studs

Splice location in wall	Minimum required fasteners on both sides of studs over the splice
Up to 10%	2 pieces
10% to 25%	3 pieces

#### 2. 1.15mm studs

Splice location in wall	Minimum required fasteners on both sides of studs over the splice
Up to 10%	3 pieces
10% to 25%	5 pieces

**NOTE:** The splice location percentage refers to the height of the partition. For example, taking a partition 10000mm high, a 10% splice location would be located within 1,000mm of the top or bottom of the wall. A 25% splice location would be within 2000-5000mm of the top or bottom of a 10000mm high wall.

- Splices should be alternate subsequently at top and bottom of wall
- Do not splice studs between 25% and 75% of wall height
- Splicing of studs is recommended for non loadbearing partitions only
- Where splicing is not possible due to the height, use fully boxed sections

#### Nogging track

Noggings are necessary to provide bracing to the partition studs and preventing the studs from twisting when fitting the lining boards. The noggings are to be screwed, riveted or crimped to both flanges of the studs. Continuous nogging tracks 0.55mm and 0.75mm are available from Rondo. This nogging track can be fitted to the stud framing in one length. Alternatively, individual noggings may be cut from the track. Noggings of 0.75mm can be used with 1.15mm studs.

#### TOP TRACK FIXING

Track to be structurally designed in accordance with BS 5950 or AS 4600, for the given opening dimensions.

#### BOTTOM TRACK FIXING

Track to be fastened to substrate floor and ceiling with M6 anchor bolts 40mm long at maximum 600mm centres. Studs can be installed vertically at 600-610mm centres depending on the board size used.

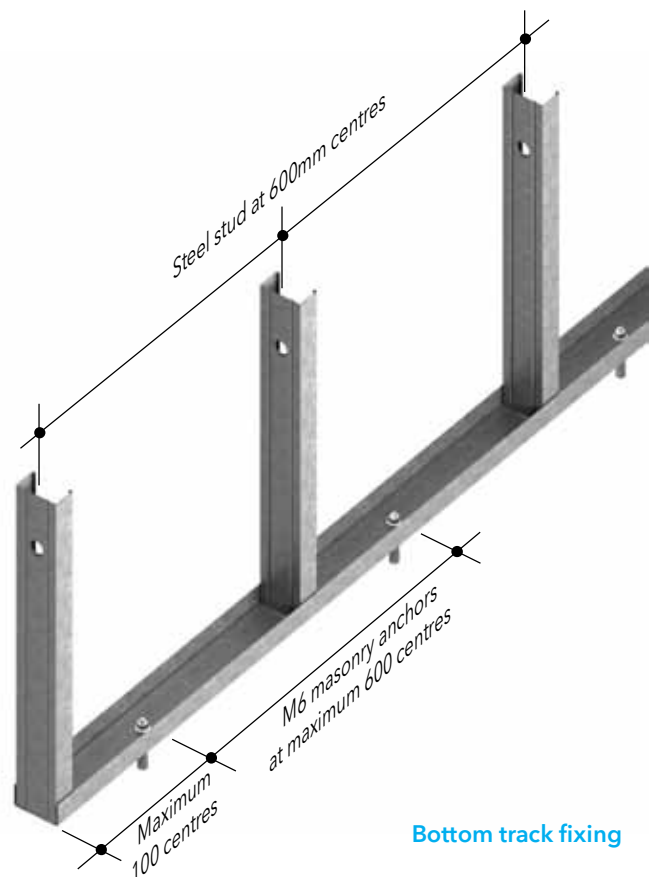

Bottom track fixing

### Horizontal track using steel studs

- Studs to be cut to a short length and screwed in between each of the vertical studs.
- Cut the base of the track leaving two short studs either side. Insert the noggings between the vertical steel studs and fix through the studs into the vertical studs on either side, using only steel rivets or screws.
- All horizontal joints of the boards are to be fixed to the noggings.

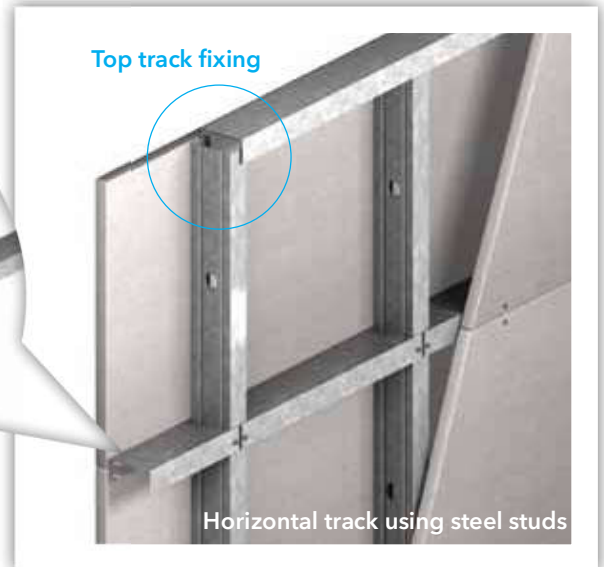
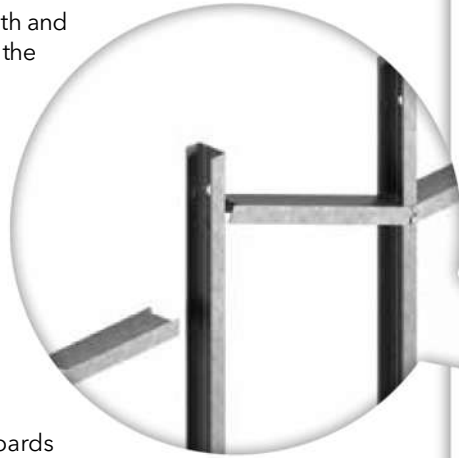

### Horizontal track using steel channels

- Steel channel cut to length and screw fixed to the both sides of the vertical studs.
- All horizontal joints of the boards are fixed to the noggings.

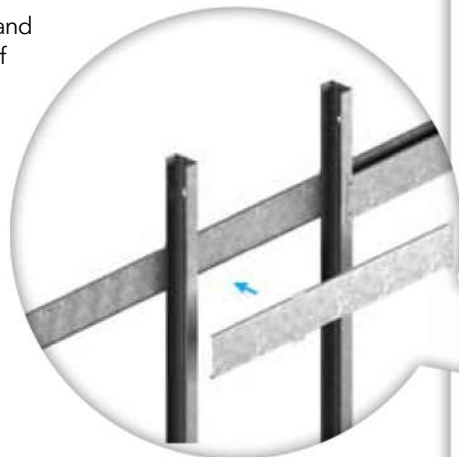

### Horizontal joints with board strips

- Cover fillets minimum 75mm wide cut from main lining boards. Fix board to board using stitching screws of a length appropriate to the board thickness, at maximum nominal 200mm centres.
- All horizontal joints of the boards to be covered and fixed by board strips.

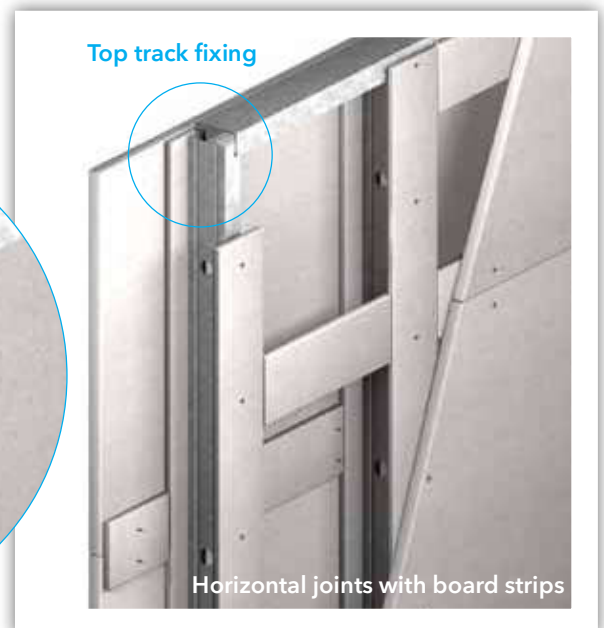
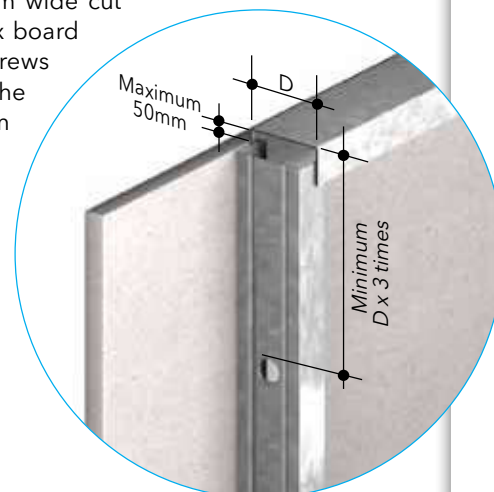

Top track fixing





### Timber Frame Components

#### Timber frame

Timber has very good performance in fire. It does burn but at a relatively slow and to a predictable depth known as the charring rate. This is one major advantage of using timber over steel because the fire resistance of timber elements of construction may be calculated based on a predictable charring rate.

Timber also has a very low thermal conductivity value and hence does not heat uniformly. Therefore, timber material a few millimetres inside the burning zone is just warm. The formation of a self insulating char provides some resistance to further heat penetration.

Unlike materials with a high thermal conductivity such as steel, there are less problems associated with expansion or loss of strength due to increases in temperature over the whole section in timber. This means that in some instances timber retains its structural integrity better than steel.

There are many different types of timbers and they all char at varying rates. Higher density timbers char generally (but not always) more slowly than those of lower density. Denser hardwoods used for structural purposes, such as jarrah, teak, keruing and greenheart, char at a rate of approximately 15mm in 30 minutes. Lower density (<math><650\text{kg/m}^3</math>) softwood timbers such as Western red cedar have an estimated charring rate of 25mm in 30 minutes.

Tables are available which can provide a definitive charring rate for a specific timber species, and can be based on the use of heartwood or sapwood of the given species.

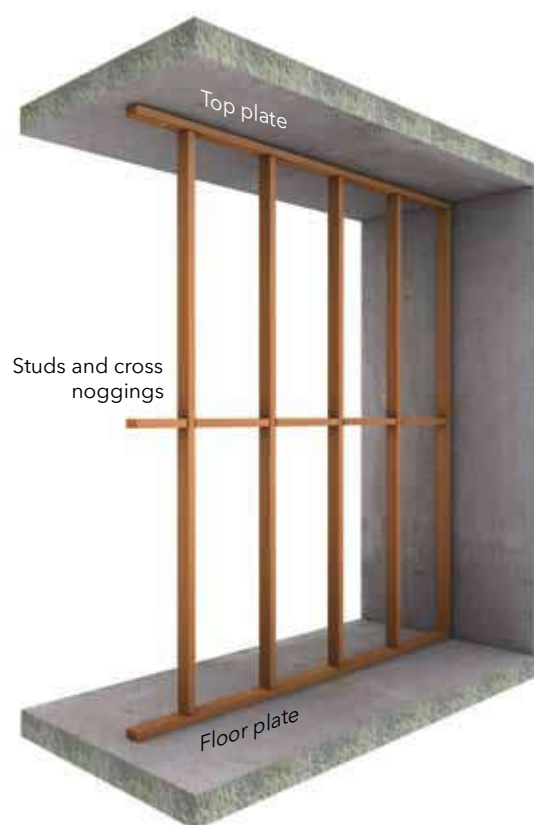

### Studs & cross noggings

The frame used in timber stud partitions generally consists of 90mm deep x 45mm wide softwood timber. The fire performance of the partition system accounts for the loss of the timber section due to charring effect without compromising the fire performance of the partition.

Where the boards are to be installed with their long edges vertical, the studs are located at maximum 600mm or 610mm centres (depending on the board width) with cross noggings at 1200mm or 1220mm centres. Where the boards are to be installed with their long edges horizontal, the studs are located at 600mm or 610mm centres with cross noggings at 1200mm or 1220mm centres.

The cross noggings may be fixed to the studs using nails or woodscrews of at least 100mm long. See fixing methods at left. Either method can be adopted to fix the cross noggings.

### Top & floor plates

The top and floor plates are to be of the same material and dimensions as the studs. They are to be secured to the surrounding structure with minimum 100mm long M6 masonry anchors with minimum 600mm centres with the drilled depth into the concrete structure of at least 40mm. Polyamide nylon anchor sleeves may be allowed for use with timber framing.

The vertical studs are fixed to the top and floor plates using either nails or woodscrews of at least 100mm long in the manner shown in the left picture.

### Loadbearing partition

Where a partition is loadbearing, the required size of the stud shall be calculated by a suitably qualified structural engineer. Care should be taken to ensure that the loadbearing partition has been designed to resist all applied loads and in accordance with BS 5268: Part 4, AS 1720: Part 1 or AS 1684. Generally, the fire performance and the load carrying capacity will improve by increasing the cross-sectional dimensions of the timber elements and/or decreasing the stud spacing.



### Cross noggling method 1



Step one

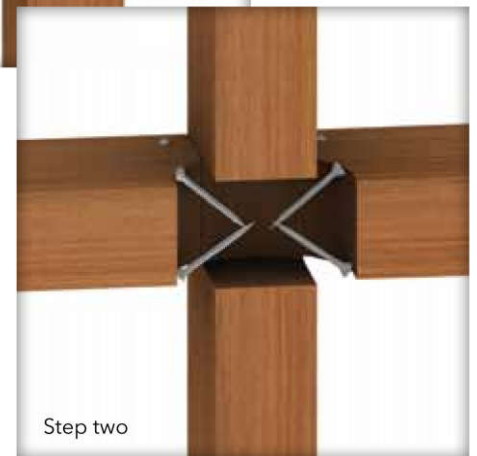

Step two

### Cross noggling method 2

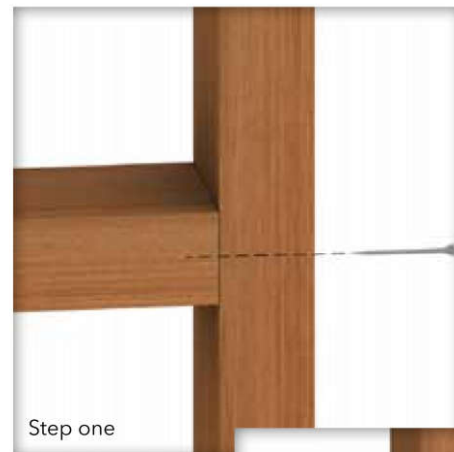

Step one



Step two



### Acoustics in building

Sound is a form of energy generated by a source, transmitted through a medium and collected by a receiver. It can be pleasant to be heard, such as music and speeches etc, while some, such as scratching a glass surface with a sharp object, are irritating. This offensive sound is commonly termed noise. The acoustic design of buildings can be divided into two basic requirements, noise control and room acoustics.

Noise control relates to the quantity of sound with an objective to ensure the sound level does not adversely affect the comfort of building occupants. This involves control of sound produced in a room, such as telephones ringing, as well as limiting the noise entering from other rooms or outside the building. A common solution targeting this problem is the introduction of sound absorption systems.

Room acoustics relate to the quality of sound with an objective to enhance the quality of desired sound within a room. This involves factors such as speech intelligibility and perception of musical clarity. The most widely applied solution employed by building designers is the use of a sound insulating system.

A point worth noting is that although both noise control and room acoustics have independent objectives, they are however inter-related in practice. As this section of technical handbook covers partition and ceiling systems, the following concentrates only on issues related to sound insulation which involves transmission loss (TL) of airborne sound.

### Sound transmission & classification

The sound transmission loss of a building element, such as a partition, is a measure of how much sound is reduced as it passes through the barrier, expressed in dB or decibels, the unit used to quantify sound. The generally accepted term for the single number ratings for sound transmission loss is the Sound Transmission Class or STC (ASTM E413-87). This is determined by comparing the TL value to the reference curve in ASTM E413-87. Generally the higher the STC value, the better the performance of the system. The following table provides a rough idea of what various STC levels mean in terms of privacy afforded.

STC	Privacy afforded
25	Normal speech easily understood
30	Normal speech audible, but unintelligible
35	Loud speech understood
40	Loud speech audible, but unintelligible
45	Loud speech barely audible
50	Shouting barely audible
55	Shouting not audible

Source: U.S. Dept of Commerce/National Bureau of Standards Handbook, "Quieting: A Practical Guide to Noise Control".

Another widely accepted equivalent term is the Weighted Sound Reduction Index or  $R_w$  (ISO 717: Part 1: 1996 or BS 5821: Part 1: 1984). It is determined in a similar manner but instead of TL values, an equivalent Sound Reduction Index ( $R$  or  $R_w$ ), is used.

Note should be taken that results obtained in STC and  $R_w$  may have a  $\pm 3$ dB deviation from one another.

Most building structures are not built like laboratories and it is very common that the sound insulation rating measured in ideal test conditions will not be achieved in a building. In order to meet the desired level of performance, building designers should therefore carefully consider the compatibility of the selected system with the supporting structure. Note that field performance is typically lower than laboratory performance by approximately 10%.

### General design considerations

With modern design concepts and technology in building construction, acoustic performance within buildings has become an important element for consideration by building designers. There are many factors involved in establishing an ideal noise level for any particular building space, some of which are as follows:

*Continued on opposite page*

- To avoid fatigue induced by noise;
- To prevent distraction or disturbance;
- To maintain a good communication and listening environment.

Heavy walls such as concrete have good transmission loss. However, there are some drawbacks which limit their performance. Mass law dictates that a wall will increase its transmission loss by only 5dB for every doubling of mass. Therefore, a single 100mm thick concrete wall of 2300kg/m<sup>3</sup> density might have an STC 45 rating whereas a 200mm thick concrete wall would only achieve STC 50 for a doubling in mass.

For most owners and builders, a wall of this size and weight is not desirable. Cost may more than double and the decibel-per-dollar achieved is clearly not acceptable. This limitation can be easily overcome by using a lightweight system, i.e. the partition system, where it is more practical to utilise principals such as air cavity, resilient mountings, sound absorbing core materials or a combination of these principals without the large increase in mass required for solid walls.

Following are some common practices that are effective for noise control and room acoustics.

---

### 1. Double studding & air cavity

---

With typical dry wall partitions, sound striking at the wall surface is transmitted through the first surface material into the wall cavity. It then strikes the opposite wall surface, causing it to vibrate and transmit the sound into the air of the adjoining room. This is termed airborne sound. When the sound strikes the wall at the stud, sound is transmitted direct through the stud and is termed structure borne sound.

The principal of double studding basically means separation of two panels of a drywall partition into a double-leaf wall, integrated with appropriate air spacing (cavity) between the leaves. The introduction of an air-space provides some form of separation or discontinuity between the two wall faces in a double-leaves wall.

As an example, a double stud partition creating an air cavity eliminates direct mechanical connection between the surfaces. The sound transmission is reduced by breaking the sound path. In addition, the air cavity provides vibration isolation between the two sides. Sound in one room striking the one side of the wall causes it to vibrate but because of the mechanical separation and the cushioning effect of the cavity, the vibration of the other side is greatly reduced.

---

### 2. Sound absorbing core material

---

Sound absorption is the effectiveness of a material at preventing the reflection of sound. Generally, the more sound absorption, the fewer echoes will exist. The sound absorbing core used in the Promat partition designs can be mineral or rock wool, glass wool or polyester, depending upon fire resistance requirements.

This core will further improve the sound isolation performance of the wall by absorbing sound energy in the cavity before the sound can set the opposite wall surface in motion. They will also provide some damping of the vibrating wall surface.

---

### 3. Treatment to flanking paths

---

When working with acoustic systems, it is critical that strict attention be paid to construction and detailing. The acoustic integrity of a system can be influenced by the combination of elements that make up the system. Single leaf and uninsulated systems are particularly dependent on high quality of installation. For example, if there is a gap of 5mm wide around the perimeter of an STC 45 rated wall of 3m x 3m, the actual performance would degrade to about STC 30. Therefore, to make acoustically rated partitions effective, they must be airtight. Any path for air also means there is a path for sound. In order to achieve the designed STC rating closely, the following factors must also be taken into account:

- Sound paths, e.g. windows, doors, floors and ceilings;
- Penetrations through walls, even above ceilings or below floorings, must be sealed;
- Stagger the joints between multiple layers of wall boards or ceiling linings;
- Do not install electrical points back to back on either side of a wall;
- Openings for return air in ceiling plenum systems must be strictly controlled.

---

### 4. Wall & floor intersections

---

A good acoustic partition is only as good as its joint or intersection at wall and floor, like a chain and its weakest link. If this joint or intersection is not treated properly, the acoustic value may be lost. Many joint defects from flanking paths allow sound to travel via air gaps through the structure.

Acoustic sealants are the simplest means to provide a permanent air tight seal. They are made from materials that are permanently elastic which will allow floor or wall materials to move, as they are prone to do because of expansion and contraction or outside forces such as structural movement. A permanent airtight seal is the most effective way to maintain the acoustic integrity of the wall. Regardless of which system is employed, all openings, cracks and material joints should be made air tight with a permanently elastic acoustical sealant.

### System selection guide

As sound insulation requirements may vary from country to country, the table below suggests acoustic values for some typical partition installations, unless otherwise specified by the architects. Please consult Promat for more information.



#### Some sources of sound leakage

- ① Air leaks through gaps or cracks
- ② Doors
- ③ Lightweight panels above doors
- ④ Electrical outlets and service pipes
- ⑤ Partition performance
- ⑥ Sound transmission via suspended ceilings or partitions
- ⑦ Common floor heating duct
- ⑧ Common ventilation system without sound absorbent treatment
- ⑨ Lightweight mullion or partition closer
- ⑩ Appliance

STC rating			Applications for separating
Minimum	Average	Luxury	
45dB	50dB	55dB	Bedroom to bedroom
50dB	55dB	60dB	Bedroom to living room
50dB	55dB	60dB	Bedroom to lobby
45dB	50dB	55dB	Office to office
40dB	45dB	50dB	Office to general area
45dB	50dB	55dB	Office to conference room
45dB	50dB	55dB	Office to washroom
40dB	45dB	50dB	Conference room to general area
40dB	45dB	50dB	Conference room to conference room
45dB	-	-	Classroom to classroom
55dB	-	-	Classroom to shop
45dB	-	-	Classroom to recreation area
60dB	-	-	Classroom to music room

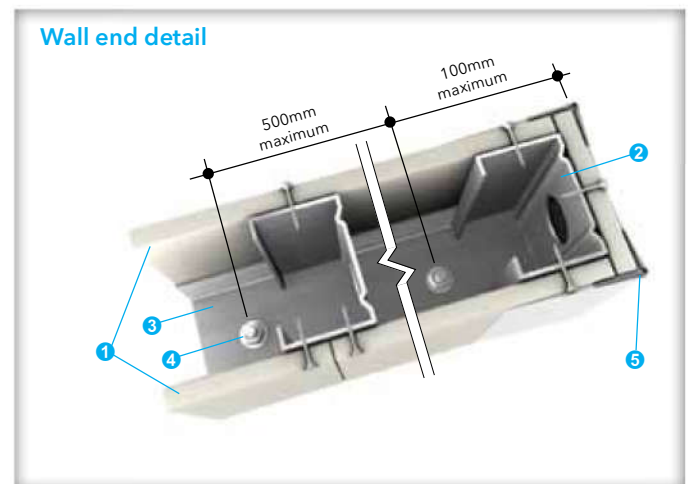
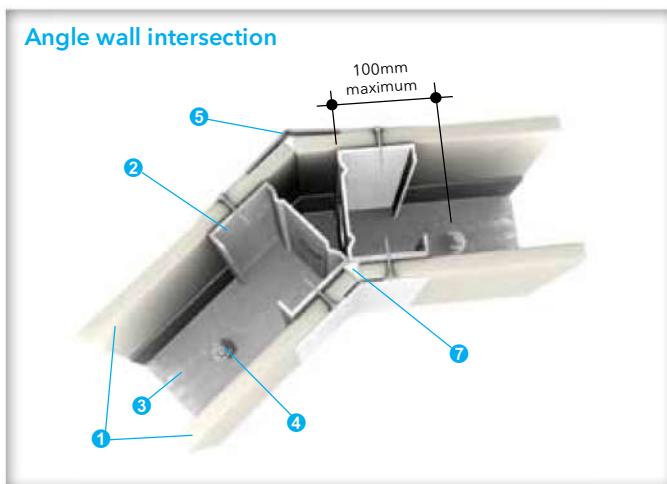
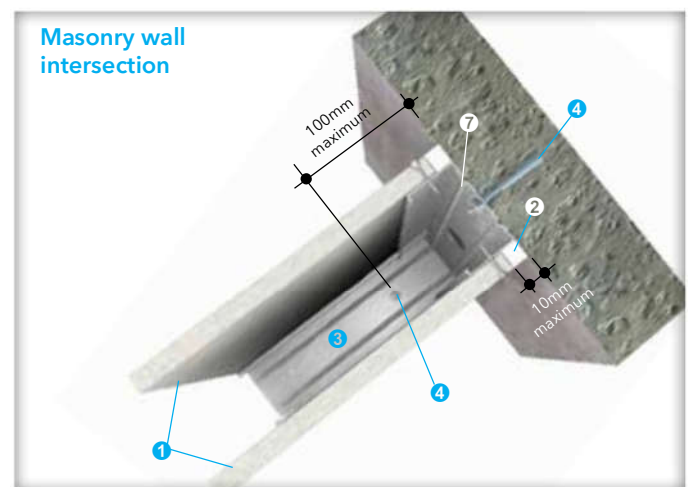
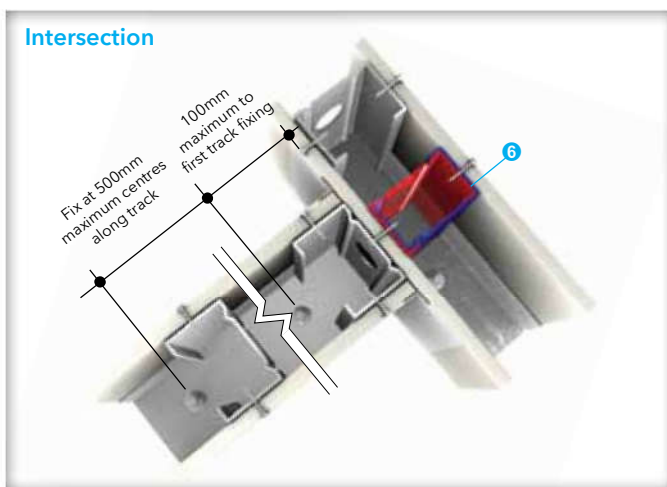
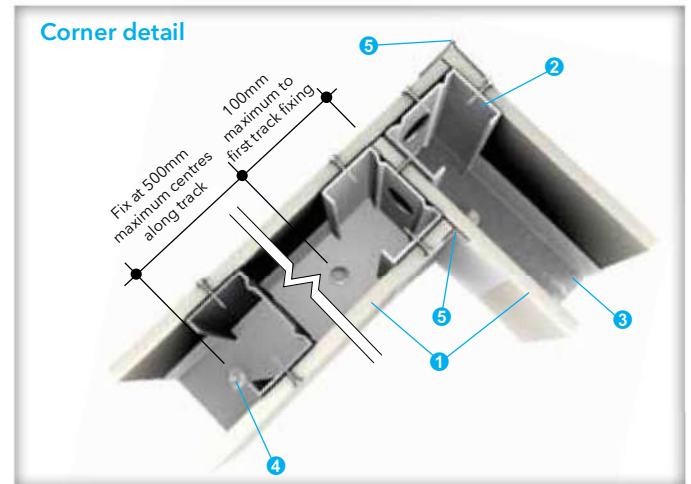
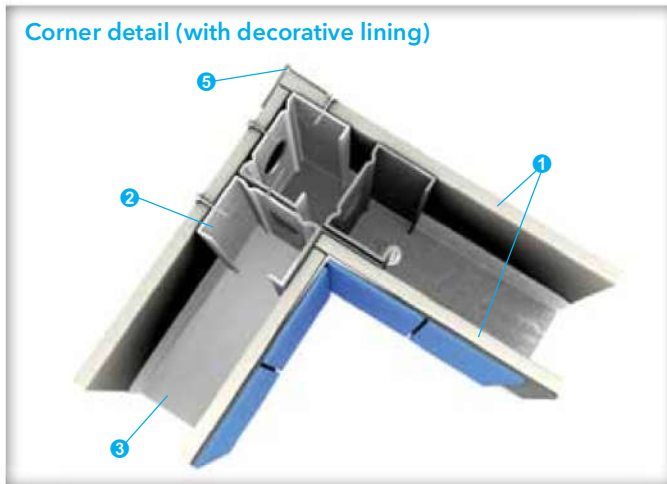

- ① PROMATECT® 100 board
- ② Steel stud at 600mm centres
- ③ Floor track
- ④ 40mm long M6 expansion bolts at 500mm centres
- ⑤ Set corner with tape and jointing compound
- ⑥ Boxed stud at wall intersection

- ⑦ Caulk all perimeter gaps with PROMASEAL®-A Acrylic Sealant to achieve the required fire resistance and/or acoustic performance

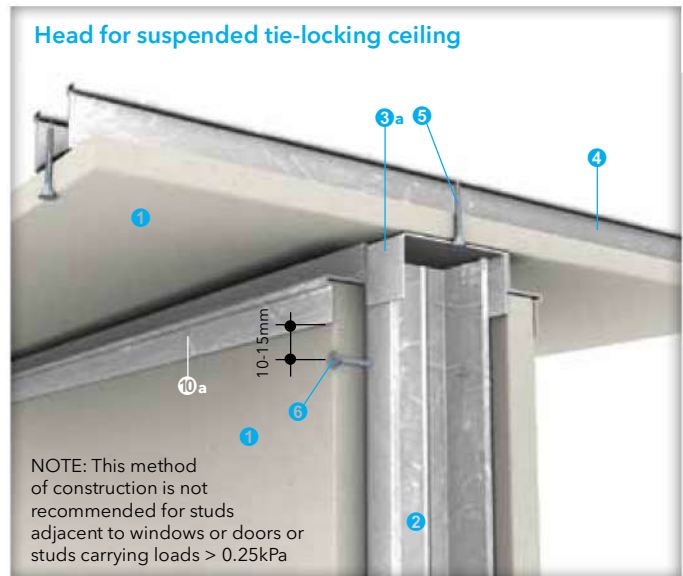
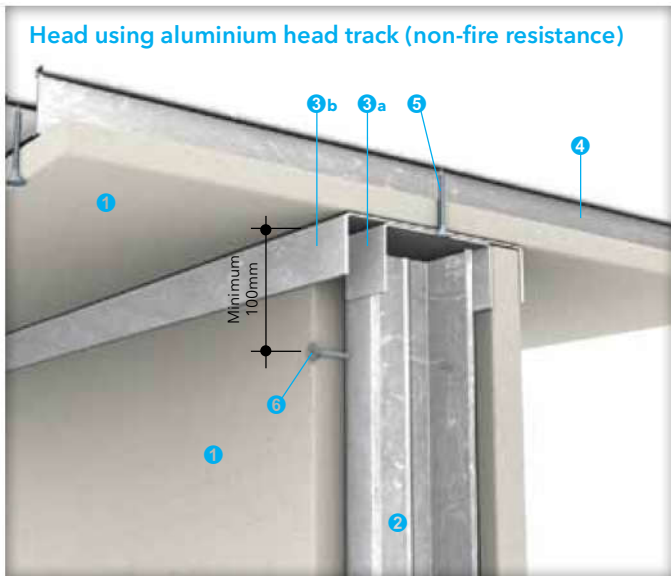
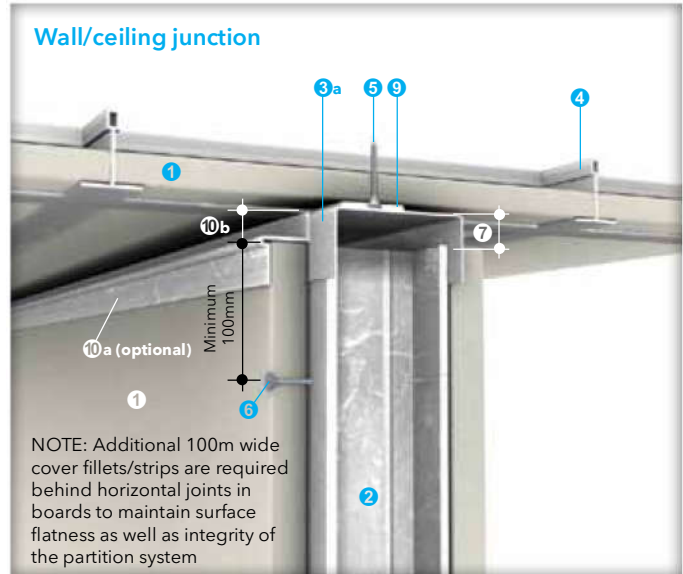
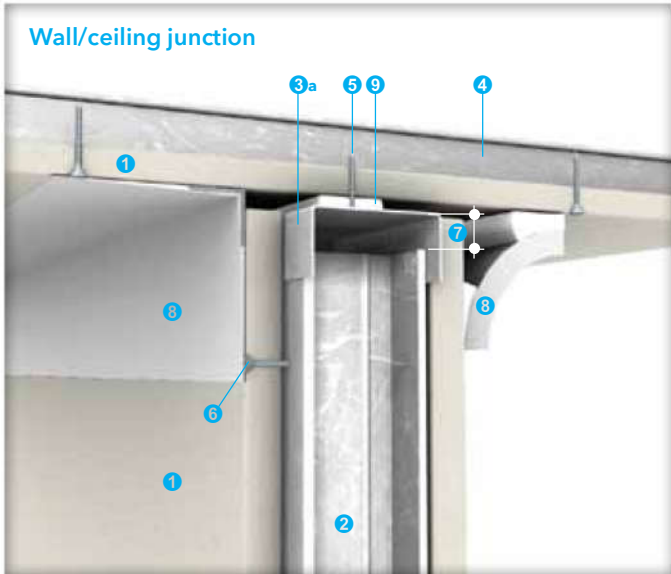

- 1 PROMATECT® 100 board
- 2 Steel stud at 600mm centres
- 3a Top track with leg length minimum 35mm to act as deflection head to accommodate vertical movement
- 3b Extruded aluminium track for 64, 76 or 92mm studs
- 4 Concealed ceiling framing
- 5 Fix top track to channel at maximum 600mm centres to ceiling framing
- 6 No. 6 drywall screws at nominal 200mm centres
- 7 Clearance minimum 8mm (for 3000mm high partition) to allow for expansion under fire conditions
- 8 Tape or cornice finishing based on requirement for aesthetic appearance
- 9 Apply sealant, e.g. PROMASEAL®-A Acrylic Sealant, above track and fix wall track to ceiling framing
- 10a Finishing bead to protect board edge from damage due to construction of ceiling and fixing of accessories such as lighting, etc
- 10b (Optional) Allow minimum 8mm clearance to accommodate adjustment. Fixing should start at minimum 100mm from corner edge to prevent unnecessary breakage

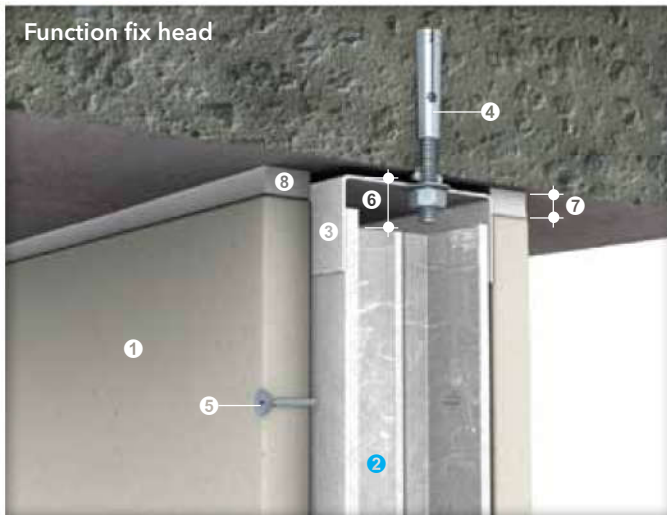

- ① PROMATECT® 100 board
- ② Steel stud at 600mm centres
- ③ Top track with minimum leg length 35mm is fixed in place by anchor bolts. Depth of track dependant upon performance requirement and partition height
- ④ Anchor bolts with minimum 40mm penetration to concrete substrate at maximum 500mm centres
- ⑤ No. 6 drywall screws at nominal 200mm centres

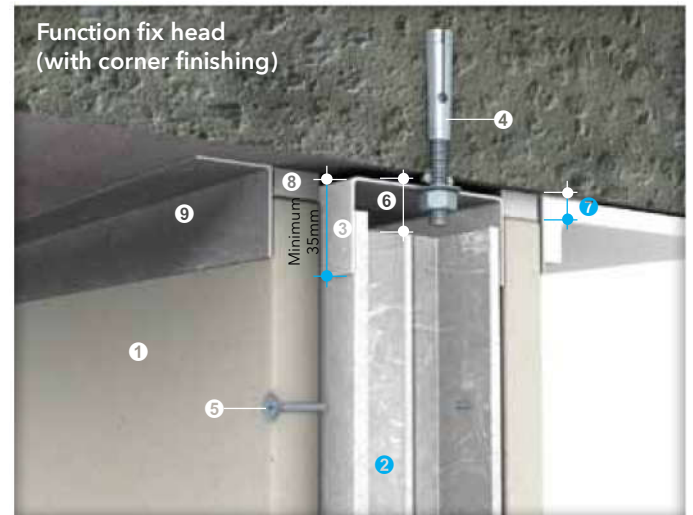

- ⑥ Minimum 6 - 8mm clearance at wall head to allow vertical expansion of steel studs
- ⑦ Allow maximum 5mm clearance between board edge and concrete soffit to accommodate structural movement, if any gap is to be sealed with PROMASEAL®-A Acrylic Sealant
- ⑧ PROMASEAL®-A Acrylic Sealant to fill gap and act as an isolator to limit sound transmission in acoustical wall construction
- ⑨ Corner finishing, e.g. tape, cornice, angle etc. dependant upon requirement of aesthetic appearance

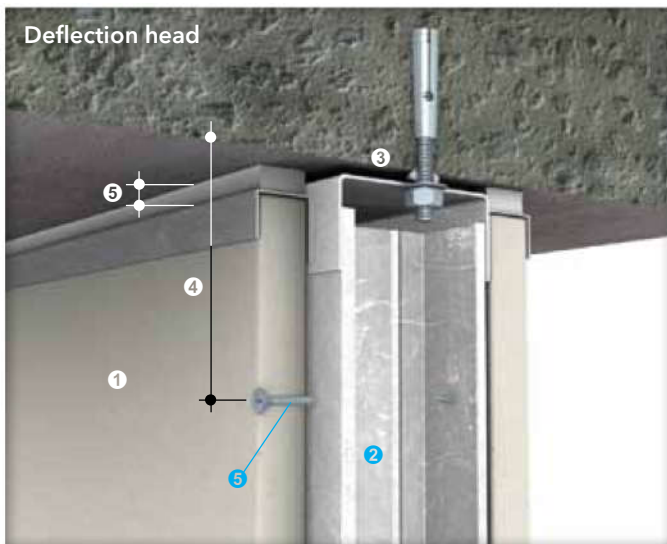

- ① PROMATECT® 100 board
- ② Steel stud at 600mm centres
- ③ Anchor bolts with minimum 40mm penetration into concrete substrate at maximum 500mm centres. For acoustic wall installation if concrete surface is uneven, apply a bead of PROMASEAL®-A Acrylic Sealant between the top track and concrete substrate to seal possible gaps
- ④ Fixing start 100mm from corner edge to avoid possible breakage under structural movement. NOTE: Should be taken that screw fixing does not fix through the track

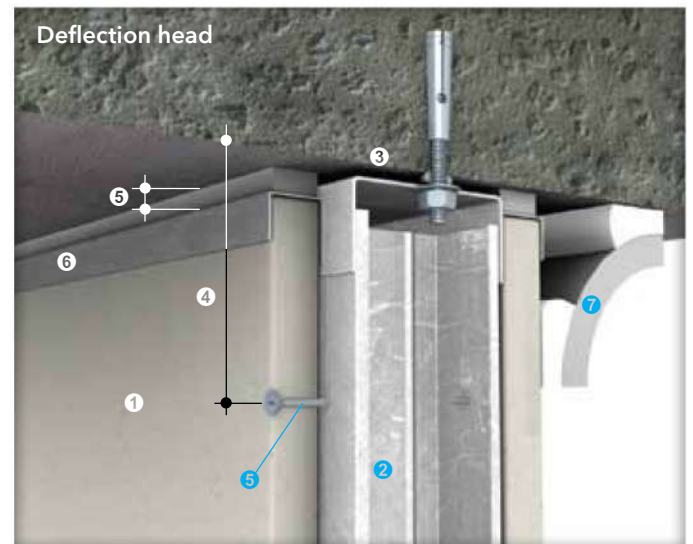

- ⑤ Allow maximum 20mm gap to accommodate vertical movement of structure. Gap is to be filled with flexible sealant such as PROMASEAL®-A Acrylic Sealant in order to optimize integrity of partition
- ⑥ Edge finishing (optional) based upon performance requirement to protect edge from damage
- ⑦ (Optional) Corner finishing, e.g. cornice based upon aesthetic requirement



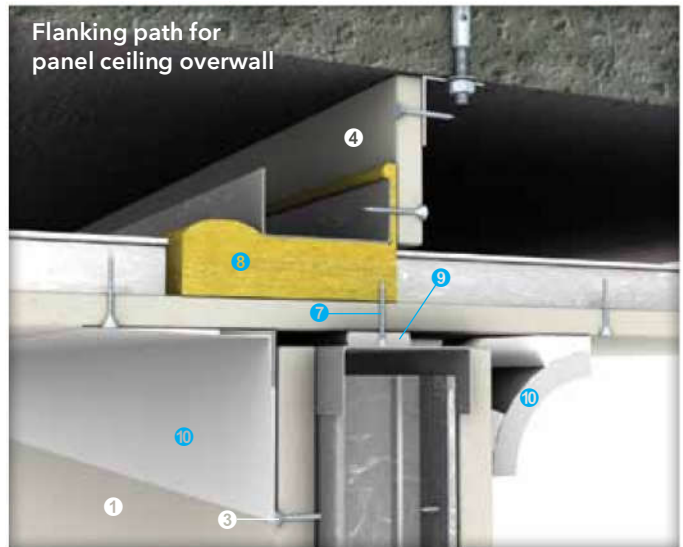
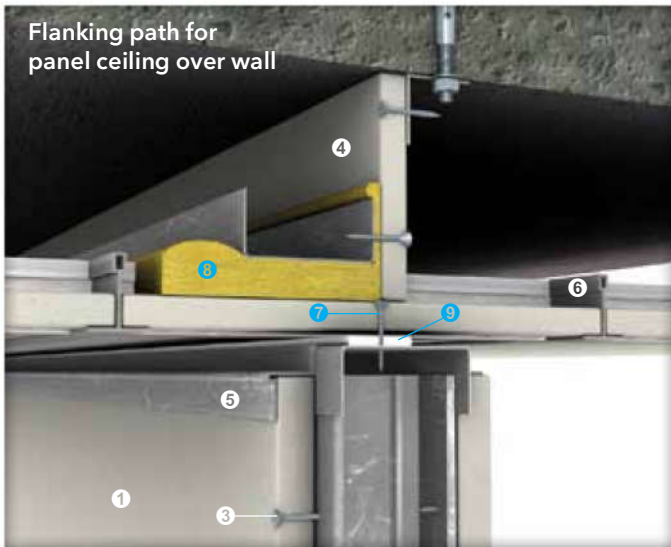

- ① PROMATECT® 100 board
- ② Use of anchor bolts at maximum 500mm centres to secure continuous angles to concrete soffit
- ③ No. 6 drywall screws at nominal 200mm centres length dependant upon board thickness
- ④ Minimum 12mm thick PROMATECT® 100 board runs over wall continuously and fixed to soffit. Joints should be backed by strips of 100mm wide PROMATECT® 100 board of similar thickness
- ⑤ Finishing head to protect board edge from damage due to ceiling construction and fixing of accessories such as lighting etc

- ⑥ Exposed grid framing system. NOTE: Due to large number of joints in ceiling construction, not recommended where high performance acoustic rating required
- ⑦ Ceiling panel screw fixed to wall track to secure in position
- ⑧ Minimum 50mm thick glass wool or equivalent sound absorbing material held in place with track or angle, should be continuous to minimize sound leakage
- ⑨ Bead of PROMASEAL®-A Acrylic Sealant isolator between top track and ceiling panel to reduce conduction of sound frequencies
- ⑩ Tape or cornice finishing based upon requirement of aesthetic appearance

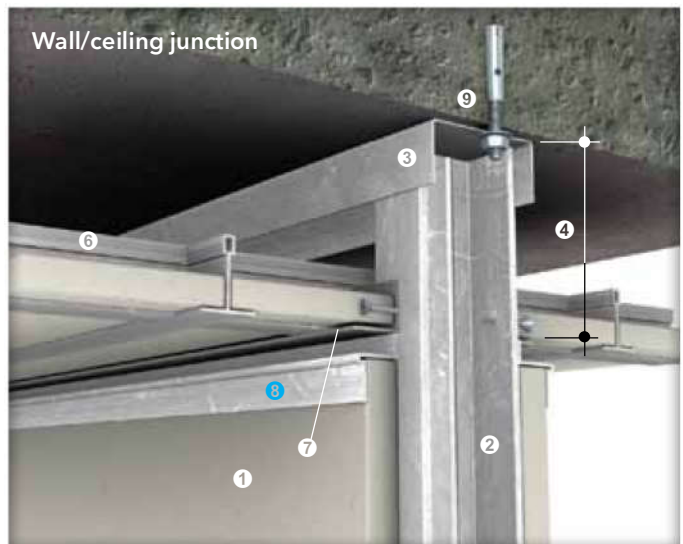

- ① PROMATECT® 100 board
- ② Steel stud at 600mm centres
- ③ Top track with minimum 35mm leg length fixed to concrete soffit using anchor bolts with minimum 40mm penetration to concrete substrate maximum spacing 500mm centres
- ④ Fixing point is minimum 100mm from corner edge of board to avoid unnecessary damage due to structure movement. Use No. 6 drywall screws
- ⑤ Set corner with tape and set or cornice finish

- ⑥ Ceiling framing, suspended from concrete soffit
- ⑦ Perimeter angle fixed to steel studs of partition wall to receive ceiling panels
- ⑧ Finishing bead to protect board edge from damage and for aesthetic appearance
- ⑨ Anchor bolts fixed to concrete substrate at maximum 500mm centres. For acoustic wall installation if concrete surface is uneven, apply a bead of PROMASEAL®-A Acrylic Sealant between the top track and concrete substrate to seal possible gap

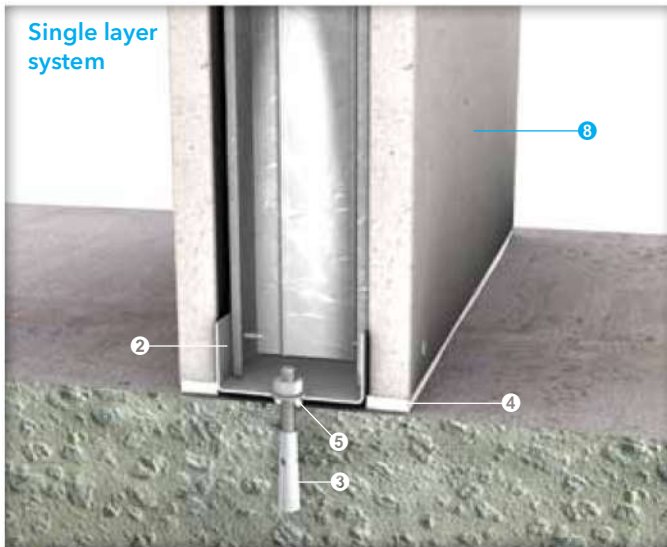

- 1 PROMATECT® 100 board
- 2 Bottom track
- 3 40mm long M6 expansion anchors at 500mm centres

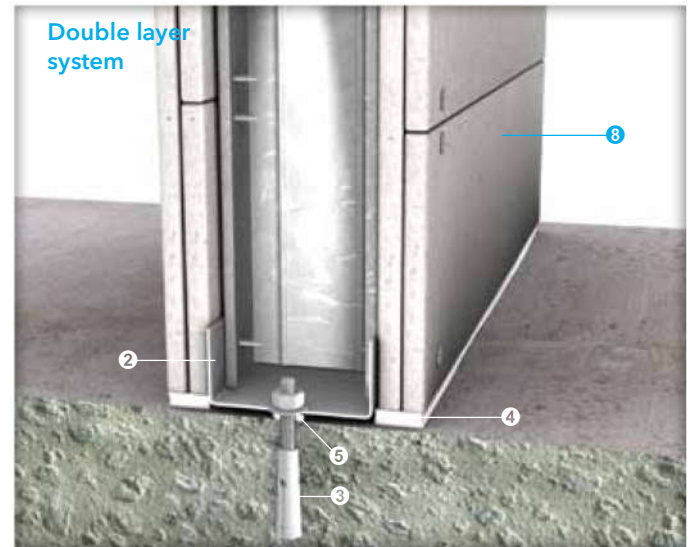

- 4 Caulk all perimeter gaps with PROMASEAL®-A Acrylic Sealant to achieve stated fire and/or acoustic performance
- 5 Continuous bead of PROMASEAL®-A Acrylic Sealant for acoustic integrity

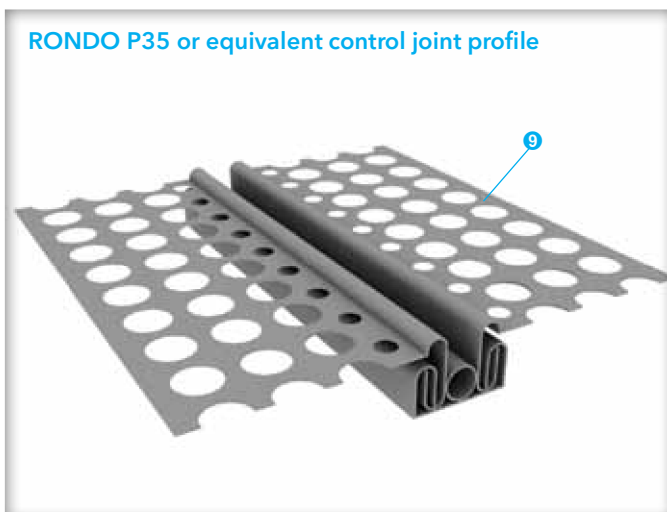
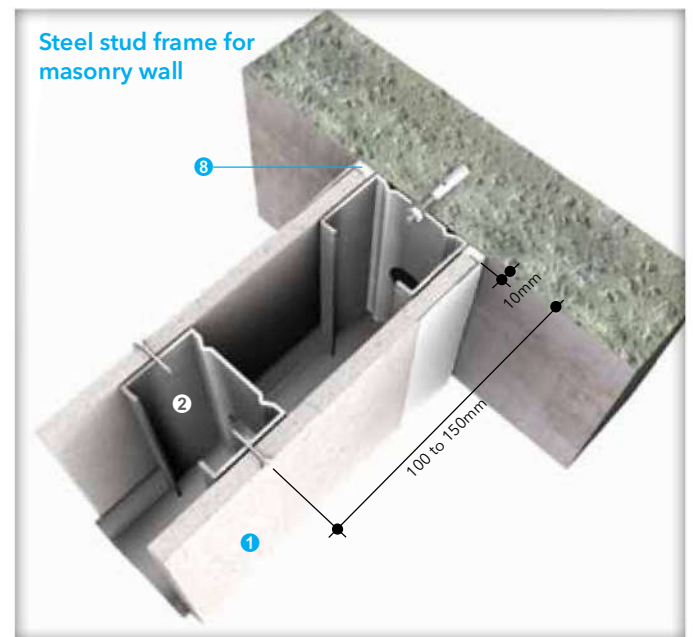
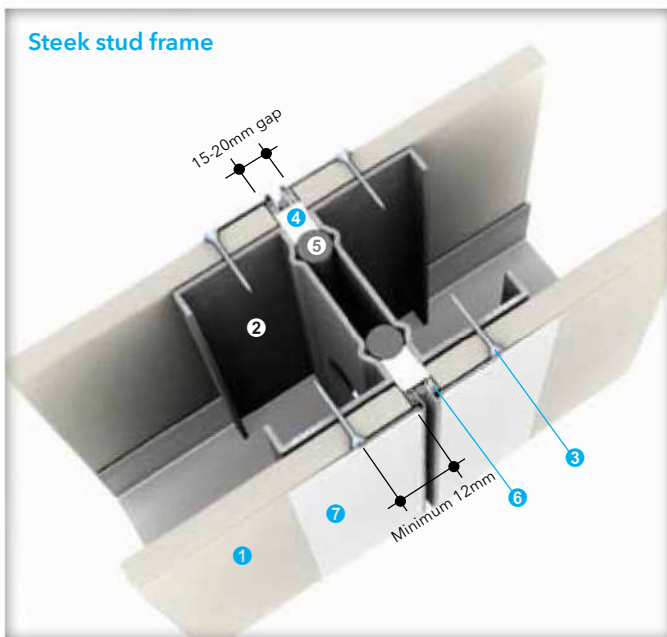

- 1 PROMATECT® 100 board
- 2 Steel studs at maximum 600mm centres
- 3 Fixing point is minimum 100mm from corner edge of board to avoid unnecessary damage due to structural movement. Use No. 6 drywall screws
- 4 PROMASEAL®-A Acrylic Sealant
- 5 Backing rod
- 6 RONDO P35 or equivalent control joint profile
- 7 Finish surface as per external angles
- 8 Caulk all perimeter gaps with PROMASEAL®-A Acrylic Sealant to achieve the required fire resistance and/or acoustic performance
- 9 Perforated locating wing

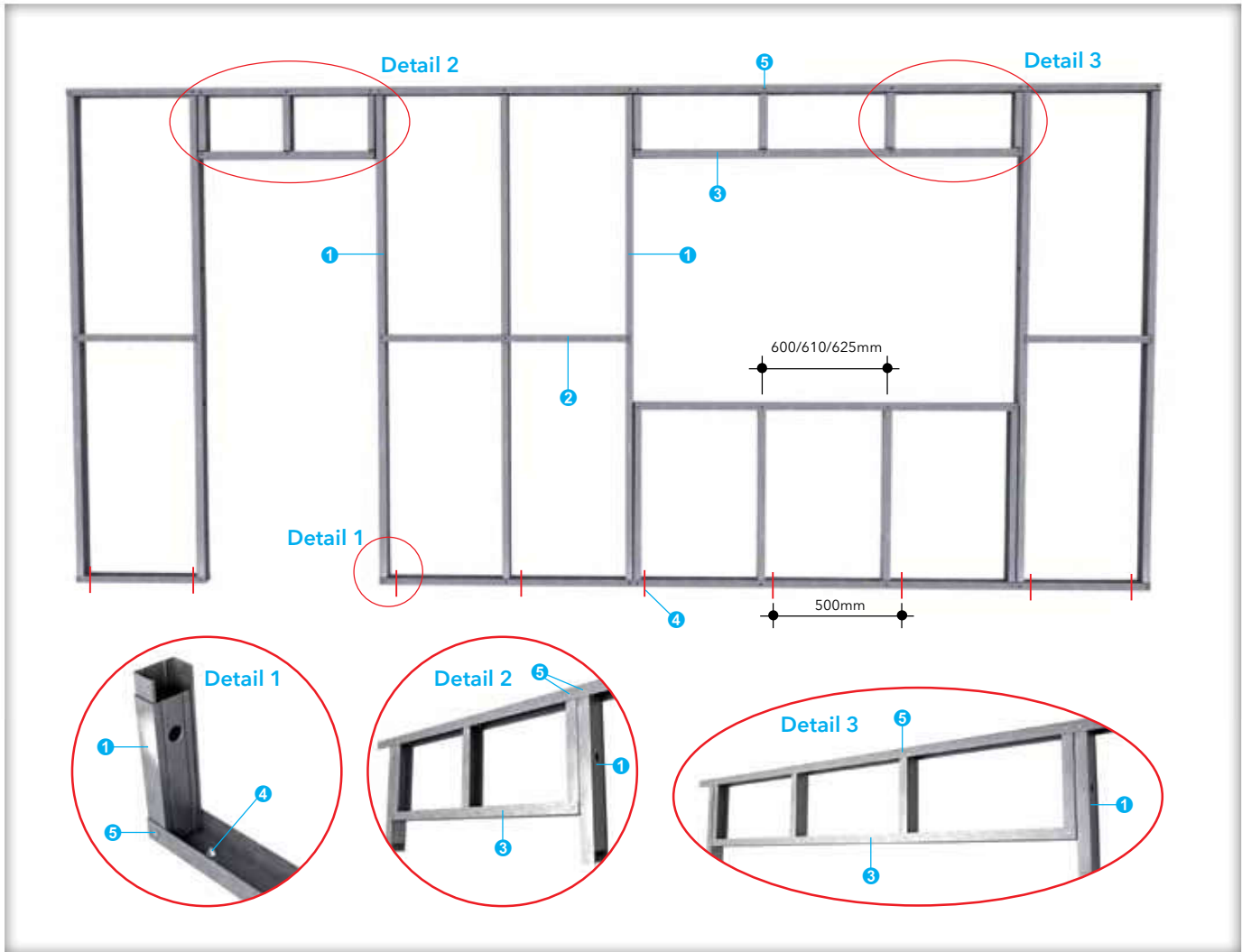

- ① Boxed studs either side of openings, the studs need to be fixed rigidly top and bottom
- ② Horizontal noggings
- ③ Stud track
- ④ Expansion bolt at 600mm centres
- ⑤ No.8 wafer head screws 16mm long or 3mm steel pop rivets

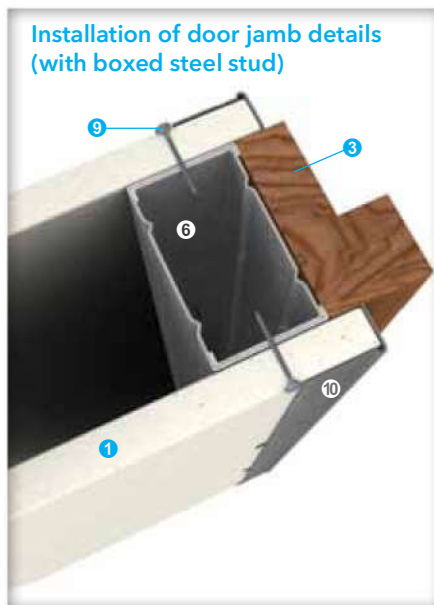
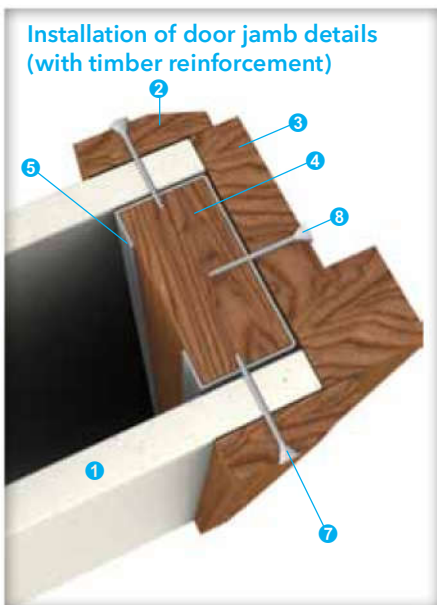

- ① PROMATECT® 100 board
- ② Timber architrave
- ③ Timber door jamb
- ④ Timber studs as reinforcement
- ⑤ Steel stud
- ⑥ Steel stud boxed
- ⑦ Screw fixing (nominal 300mm centres)
- ⑧ Screw fixing (nominal 500mm centres)
- ⑨ Screw fixing (nominal 200mm centres)
- ⑩ Edge metal profile

### Planned and unplanned loads

PROMATECT® 100 drywalls facilitate easy fixing of most type of loads or fixtures which can be attached either pre or post installation of the PROMATECT® 100 drywall system. The basic concept is that the support or special fixers/fasteners to be used will also employ the support of the framework of the drywall system. A wide range of propriety expanding fasteners are readily available to fix any load onto a PROMATECT® 100 wall or partition system. Use fasteners in accordance with to the manufacturer's recommendations.

### Details for planned and unplanned loads on PROMATECT® 100 drywalls.

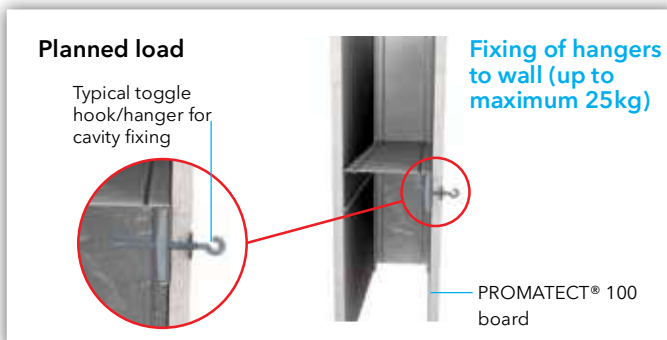
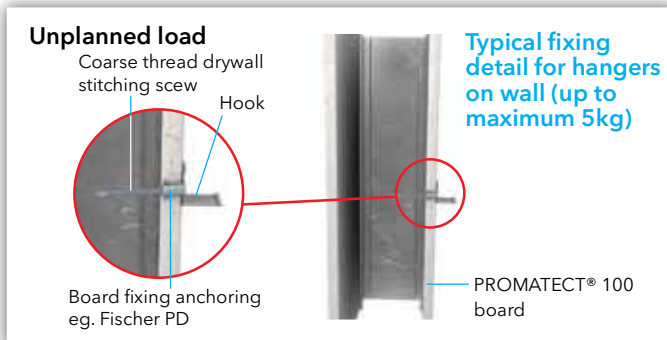

### Positioning fixtures and accessories

Most types of wall hangings such as wash basins, kitchen cabinets and shelving etc can easily be installed to PROMATECT® 100 walls or partition systems.

Typical technical details include the following:

- Planned loads up to 25kg (e.g. cabinets and wash basins) can be easily added by fixing horizontal noggins made of timber members at the desired location and securing to the steel stud frame.
- Unplanned loads up to 5kg (e.g. hanging picture frames, for example) can be added by inserting the screw or cavity fixture inclined downward at the appropriate angle, as shown above.
- For planned loads up to 25kg, horizontal noggins can be fixed to the surface of the board via two additional studs and fixing the load to the strengthening horizontal noggin.
- Fittings and fixtures such as lights and switches are easily fixed to PROMATECT® 100 drywalls. Please refer to [page 79](#) for the recommendations.
- The fitting of toilet fixtures within PROMATECT® 100 wall or partition systems are fully outlined in the recommendations on [page 74](#).

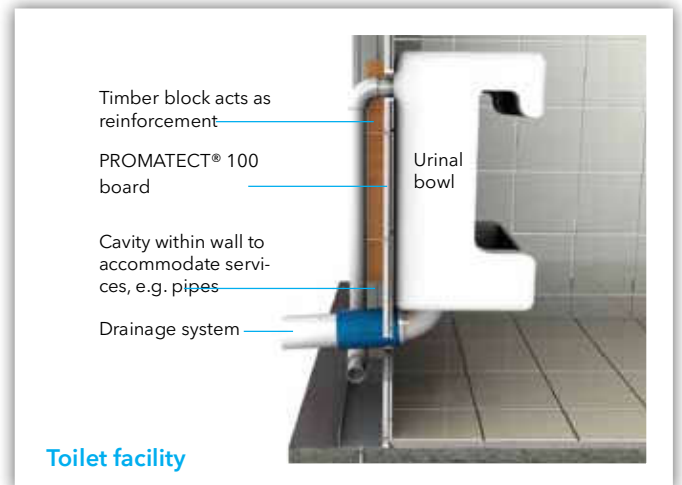
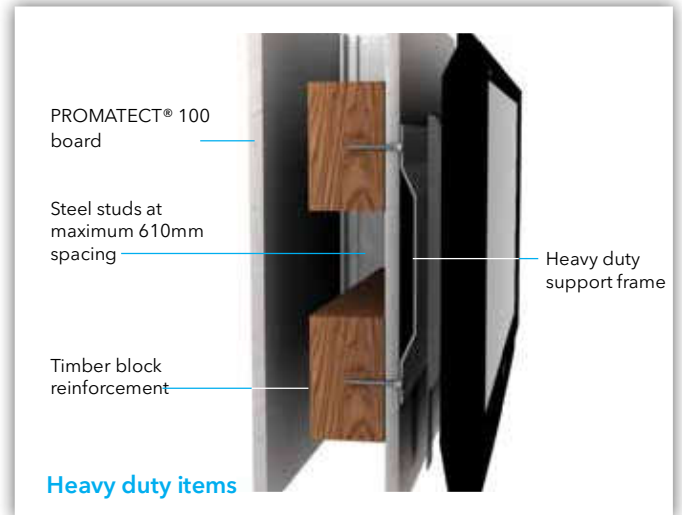

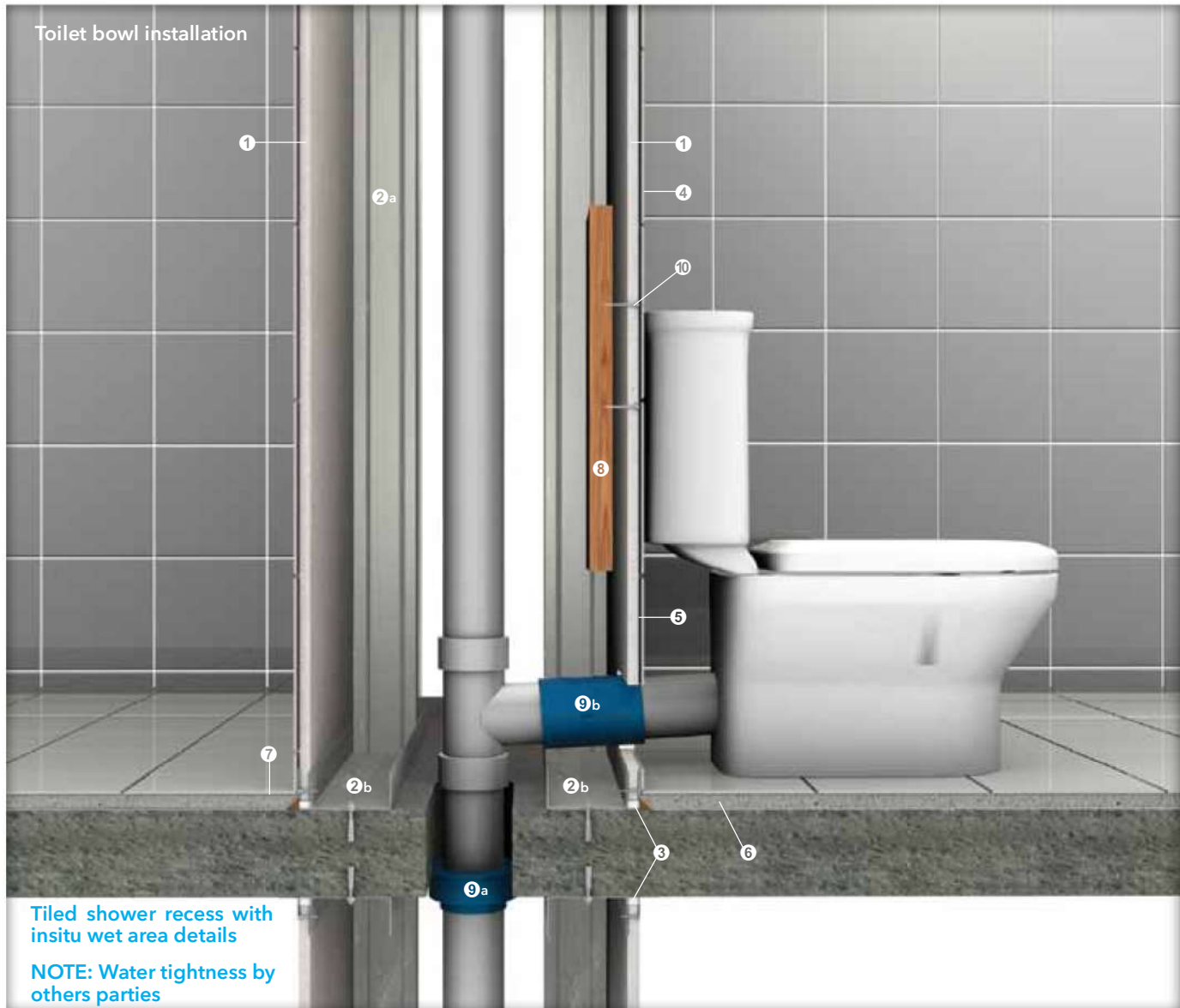

- ❶ PROMATECT® 100 board with thickness dependant upon performance requirement
- ❷ Approved flashing when required by building regulation to prevent water egress
- ❸ PROMASEAL®-A Acrylic Sealant is used to fill gap and seal joints whenever necessary to maintain integrity of wall system
- ❹ Decorative lining onto PROMATECT® 100 board  
NOTE: Installation procedures of decorative lining should be strictly in accordance with the recommendation of manufacturer/supplier
- ❺ Insitu internal membrane applied to face of wall lining to prevent moisture related problems
- ❻ Mortar bed prepared according to manufacturer specification to receive floor finishing e.g. tiles, etc
- ❼ Steel studs, spaced at maximum 600mm centres. Studs size dependant upon performance requirement and partition height
- ❽ Reinforcement material, e.g. timber plate, etc. of minimum 9mm thick to support loading
- ❾ Waste pipe made of PVC, uPVC etc. protected by PROMASEAL® FC or FCS retrofit collar to maintain compartmentation during fire conditions. For option of collars please consult Promat
- ❿ No. 6 drywall screws fixed at maximum 200mm centres length depends upon board thickness used
- Ⓜ Top and bottom tracks fixed to concrete substrate using anchor bolts at maximum 500mm centres. For top track, use track with minimum 35mm leg length to accommodate vertical movement of structure

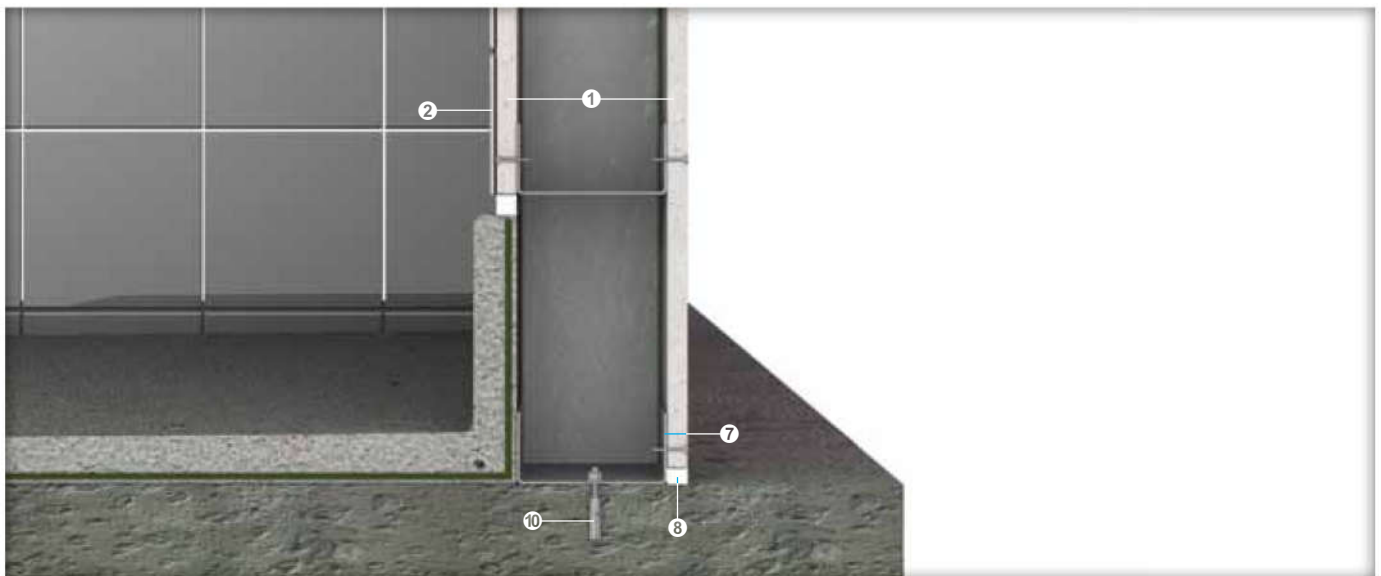

- ① PROMATECT® 100 board with thickness dependant upon performance requirement
- ② Decorative lining, e.g. ceramic or stone tiles
- ③ Use adhesive to install decorative lining. Type of adhesive and application should strictly follow manufacturers recommendations
- ④ Use of flashing tape to prevent water ingress
- ⑤ Bath tub specified by architect or designer. Installation to be carried out according to manufacturer specification
- ⑥ Supporting batten fixed to wall framing using appropriate screw fixing to secure bath tub in position
- ⑦ Bottom track
- ⑧ PROMASEAL®-A Acrylic Sealant
- ⑨ Maximum 6mm gap is allow to accommodate fixing of bath tub. Any gap thereafter should be properly sealed with appropriate flexible sealant
- ⑩ Anchor bolts bolts at maximum 500mm centres

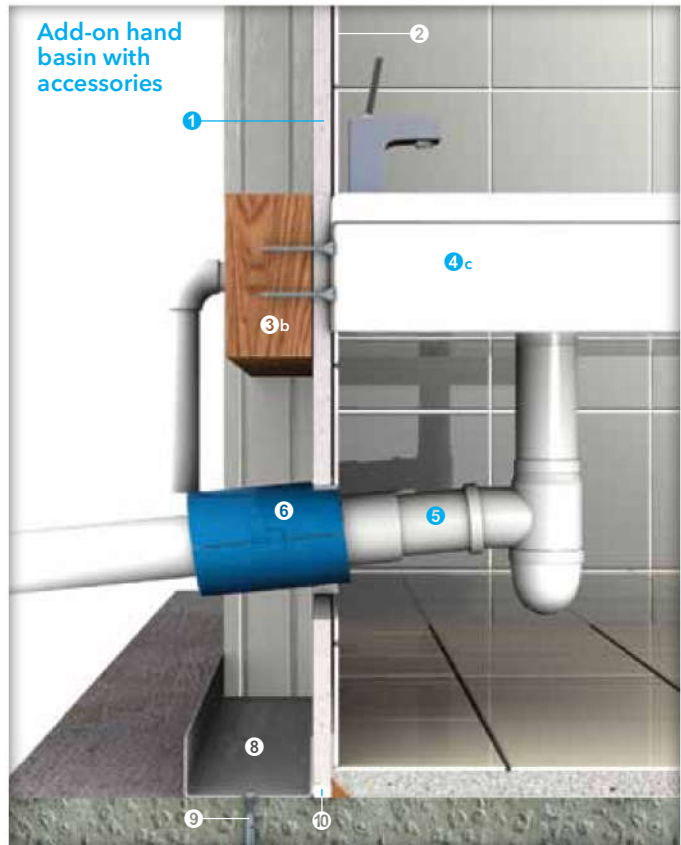
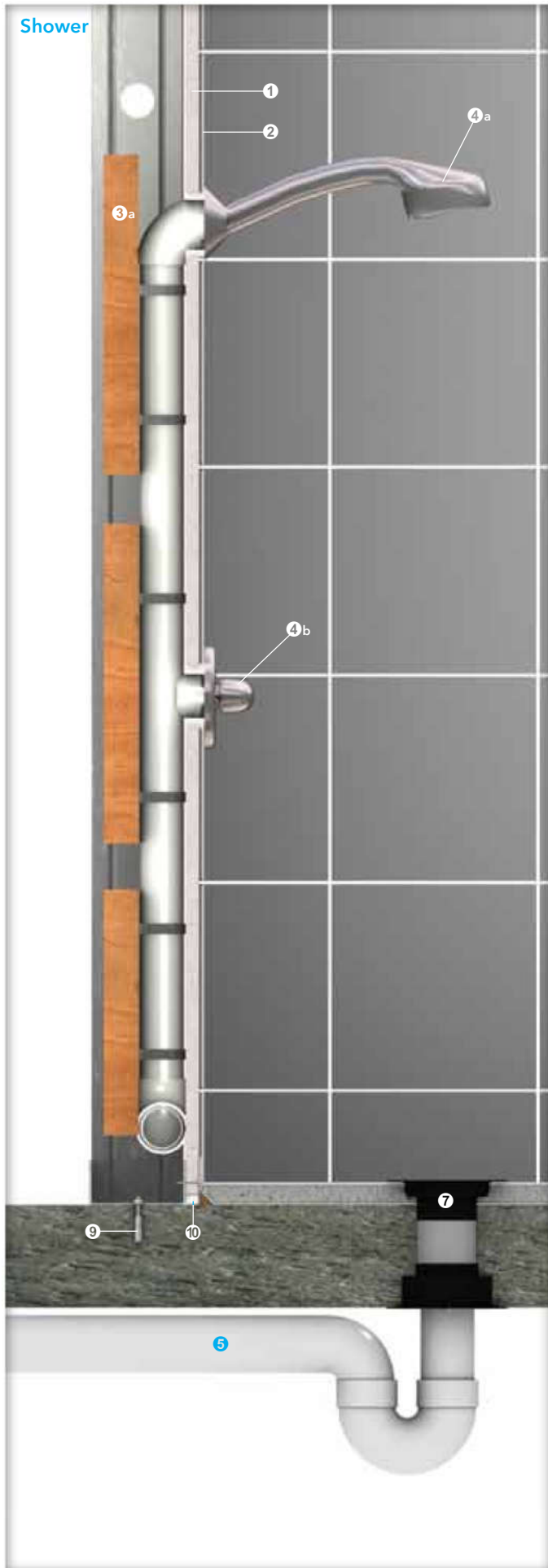

- ① PROMATECT® 100 board with thickness dependant upon performance requirement
- ② Decorative lining, e.g. ceramic or stone tiles
- ③a Timber reinforcement
- ③b Timber block fixed between steel studs acting as reinforcement to support loading from basin fixture
- ④a Typical shower head (with/without handle) as specified by architect or designer
- ④b Knob to control water inlet. This is specified by architect or designer
- ④c Basin as specified by architect or designer
- ⑤ Water waste pipe, e.g. uPVC, etc. connecting to main sewage system
- ⑥ For fire protection application; PROMASEAL® FCW wall collar can be used to prevent fire spread through opening or gap. In cases where waste pipe penetrates floor slab, PROMASEAL® FC or FCS retrofit collar system may be used instead. For other option please consult Promat
- ⑦ PromaSnap® floor waste collar
- ⑧ Bottom track
- ⑨ Anchor bolt to concrete substrate
- ⑩ PROMASEAL®-A Acrylic Sealant

Typical framing details for water tap support and penetrations

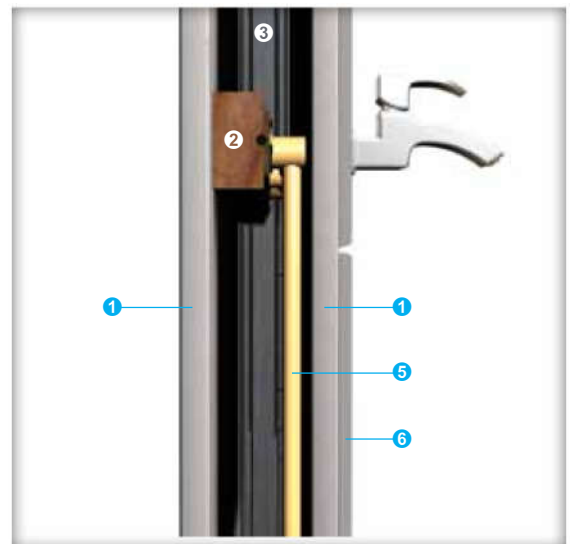

- ① PROMATECT® or PROMINA® board with thickness dependant upon performance requirement
- ② Timber supporting battern
- ③ Steel stud
- ④ PROMASEAL® A Sealant for copper and steel pipes. Use PROMASEAL® Intumescent pipe collars for plastic pipes greater than 25mm in diameter
- ⑤ uPVC or PVC or copper or steel pipework
- ⑥ Ceramic tiles



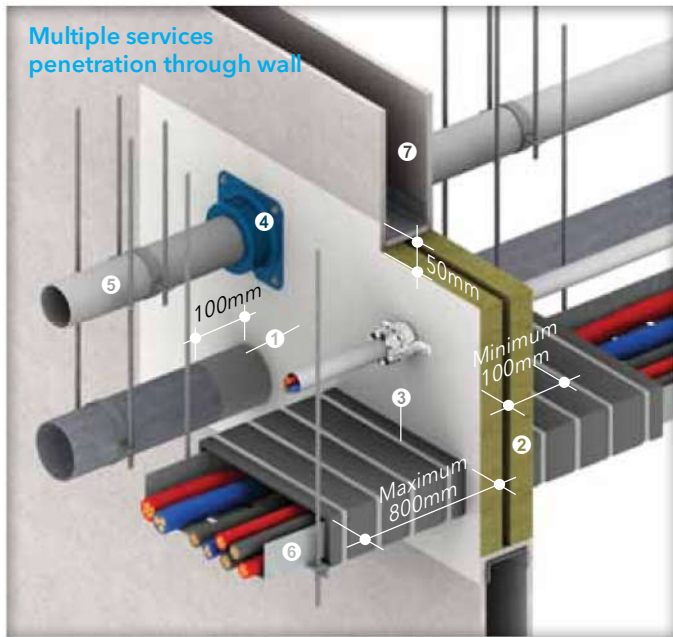

- 1 PROMASEAL® Bulkhead Sealer coating (or PROMASEAL®-A Acrylic Sealant), with minimum 100mm length of coating on the penetrating elements measured from the openings
- 2 One layer of mineral wool 50mm thick x 120kg/m<sup>3</sup> for up to -/120/90 fire resistance or two layers of PROMASEAL® Bulkhead batten 50mm thick x minimum 120kg/m<sup>3</sup> for up to -/120/120 fire resistance
- 3 PROMASEAL® Wrap
- 4 PROMASEAL® Retrofit Collar (square base) fixed through the batt with a threaded rod
- 5 Non combustible plastic pipes with appropriate support within 300mm from both sides of the Bulkhead barrier
- 6 Electrical cables supported with cable tray or steel trunking within 300mm from both sides of the Bulkhead barrier
- 7 Fire resistant concrete or masonry walls

PROMASEAL®-A Acrylic Sealant (not shown above) should be liberally applied to all joints and contact points between the Bulkhead barrier and items 3 or 5 AND between the barrier and the floor

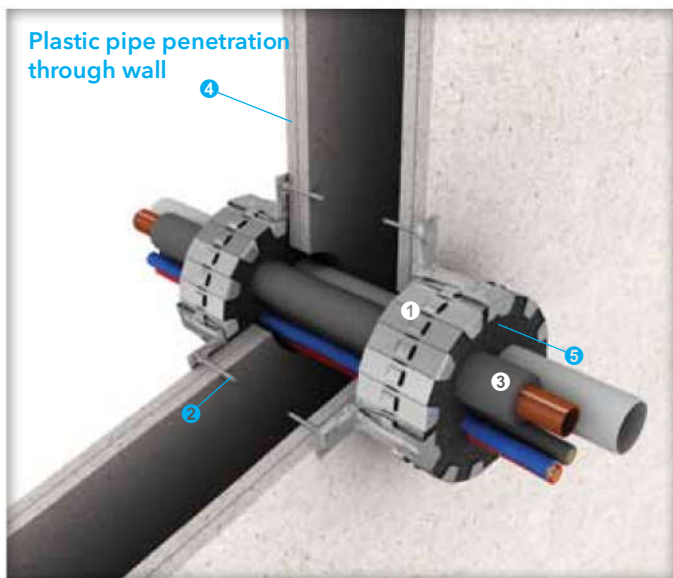

- 1 PROMASTOP® UniCollar®
- 2 Suitable fixing, i.e. laminating screws for lightweight partitions OR steel bolt anchors for masonry/concrete floors
- 3 Various building services, e.g. electrical cables, plastic (uPVC or PEX) pipes and/or insulated copper pipes
- 4 Fire resistance lightweight partitions
- 5 All gaps between collars and services filled with PROMASEAL® Grafitex



- 1 One or two layers of PROMATECT® 100 boards, maximum size 700mm x 700mm
- 2 PROMATECT® 100 board 50mm thick, fixed to concrete/masonry wall using anchor bolts or 75mm x self-tapping Teks screws steel/timber framed lightweight partition at nominal 200mm centres
- 3 PROMATECT® 100 board 9mm thick
- 4 Hinges
- 5 General building services, e.g. electrical cables, metal pipes etc
- 6 Fire resistant concrete/masonry wall or steel/timber framed lightweight partition

Curtain wall detail

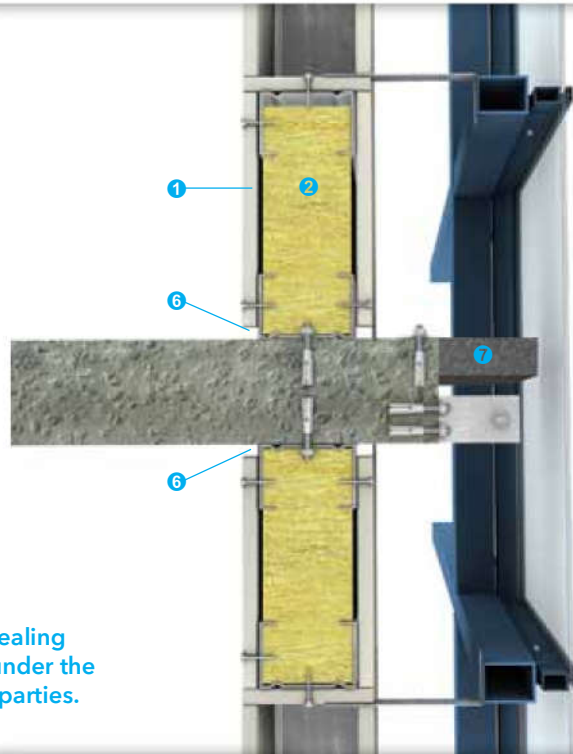

**NOTE:** Weather tight sealing and structural design under the responsibility of other parties. Please consult Promat

Power outlet/light switch installation

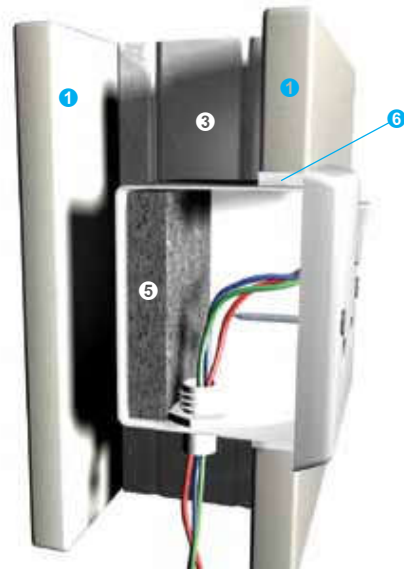
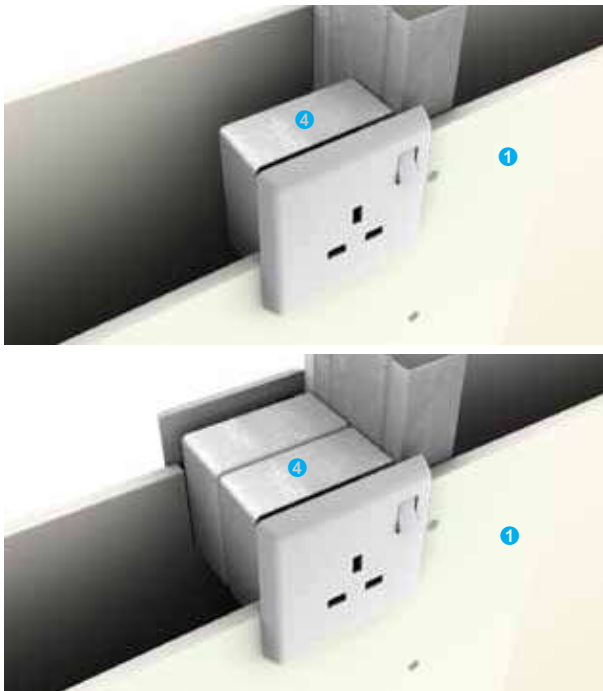

**NOTE:** For fire resistant walls, steel electrical switch boxes should be employed to avoid degrading fire performance of the wall system

- ① PROMATECT® 100 board with thickness dependant upon performance requirement
- ② Insulation material enhances thermal insulation of building
- ③ Steel studs at maximum 610mm centres. Stud size dependant upon performance requirement and partition height
- ④ Fire resistance switchbox based upon performance. Please consult Promat

- ⑤ PROMASEAL® Switchbox intumescent infill
- ⑥ PROMASEAL®-A Acrylic Sealant is used to seal gap to maintain integrity of partition system
- ⑦ PROMASEAL® Expansion Joint Strip



Fire resistance	FRL	-/60/60
	Standard	AS 1530: Part 4: 2014
	Approval	P106900-1005
Acoustic	STC, R <sub>w</sub>	See acoustic table below
	Standard	ISO 140: Part 3: 1996 ISO 717: Part 1: 1996
	Predicted assessment	Marshall Day 13th October 2016
Construction	Maximum height	5000mm
	Maximum length	Unlimited
	Partition thickness	From 94mm
	Partition mass*	From 27kg/m <sup>2</sup>

- ① One layer of PROMATECT® 100 board 15mm thick at both sides of steel studs
- ② Galvanised steel studs, measurements in accordance with Studs Tables on page 94 (allow appropriate expansion at top horizontal track, no allowance at this track for loadbearing purposes)
- ③ 25mm long self-tapping screws at maximum 300mm centres
- ④ 40mm long M6 masonry anchors at nominal 500mm centres
- ⑤ Caulk all perimeter gaps with PROMASEAL®-A Acrylic Sealant to achieve the required fire resistance and/or acoustic performance

See page 60 and 61 for bottom and top track fixings; pages 67 to 71 for details of wall head, wall base, wall junction and wall movement joints.

#### Acoustic Table

Stud depth	64mm	76mm	92mm	150mm
Cavity infill	# STC / R <sub>w</sub> (C <sub>r</sub> )			
a) Nil	41/40dB (-10)	42/41dB (-10)	42/42dB (-10)	42/44dB (-7)
b) Bradford R2.0 Soundscreen 50mm x 32kg/m <sup>3</sup>	46/46dB (-12)	48/47dB (-11)	49/48dB (-11)	50/50dB (-8)
c) Bradford R2.0 Soundscreen 75mm x 32kg/m <sup>3</sup>	46/46dB (-12)	48/47dB (-11)	49/48dB (-10)	50/50dB (-8)
d) R1.8 Pink Wall Batts 60mm x 9kg/m <sup>3</sup>	45/45dB (-12)	47/46dB (-11)	49/47dB (-11)	50/49dB (-8)

**NOTE:** Above values are predicted figures. # Margin of error is generally within ±3dB



Fire resistance	FRL	-/120/120
	Standard	AS 1530: Part 4: 2014
	Approval	WFRA 45883 P106900-1005
Acoustic	STC, R <sub>w</sub>	See acoustic table below
	Standard	ISO 140: Part 3: 1996 ISO 717: Part 1: 1996
	Predicted assessment	Marshall Day 18th October 2006
Construction	Maximum height*	4000mm
	Maximum length	Unlimited
	Partition thickness	From 104mm
	Partition mass*	From 35kg/m <sup>2</sup>

\* Details for walls above 8500mm high are available on request

- 1 One layer of PROMATECT® 100 board 20mm thick at both sides of steel studs
- 2 Galvanised steel studs, measurements in accordance with Studs Tables on page 94 (allow appropriate expansion at top horizontal track, no allowance at this track for loadbearing purposes)
- 3 45mm long self-tapping screws at maximum 300mm centres
- 4 40mm long M6 masonry anchors at nominal 500mm centres
- 5 Caulk all perimeter gaps with PROMASEAL®-A Acrylic Sealant to achieve the required fire resistance and/or acoustic performance

See page 60 and 61 for bottom and top track fixings; pages 67 to 71 for details of wall head, wall base, wall junction and wall movement joints.

#### Acoustic Table

Stud depth	64mm	76mm	92mm	150mm
Cavity infill	# STC / R <sub>w</sub> (C <sub>tr</sub> )			
a) Nil	42/43dB (-11)	42/43dB (-9)	42/44dB (-9)	42/46dB (-7)
b) Bradford R2.0 Soundscreen 50mm x 32kg/m <sup>3</sup>	48/48dB (-10)	48/49dB (-10)	48/49dB (-8)	48/51dB (-7)
c) Bradford R2.0 Soundscreen 75mm x 32kg/m <sup>3</sup>	49/48dB (-10)	49/49dB (-10)	49/50dB (-9)	49/51dB (-7)
d) R1.8 Pink Wall Batts 60mm x 9kg/m <sup>3</sup>	48/47dB (-11)	48/48dB (-10)	48/49dB (-9)	48/51dB (-8)

NOTE: Above values are predicted figures. # Margin of error is generally within ±3dB

### Vertical sheeting (Below 3000mm) / Non loadbearing and loadbearing

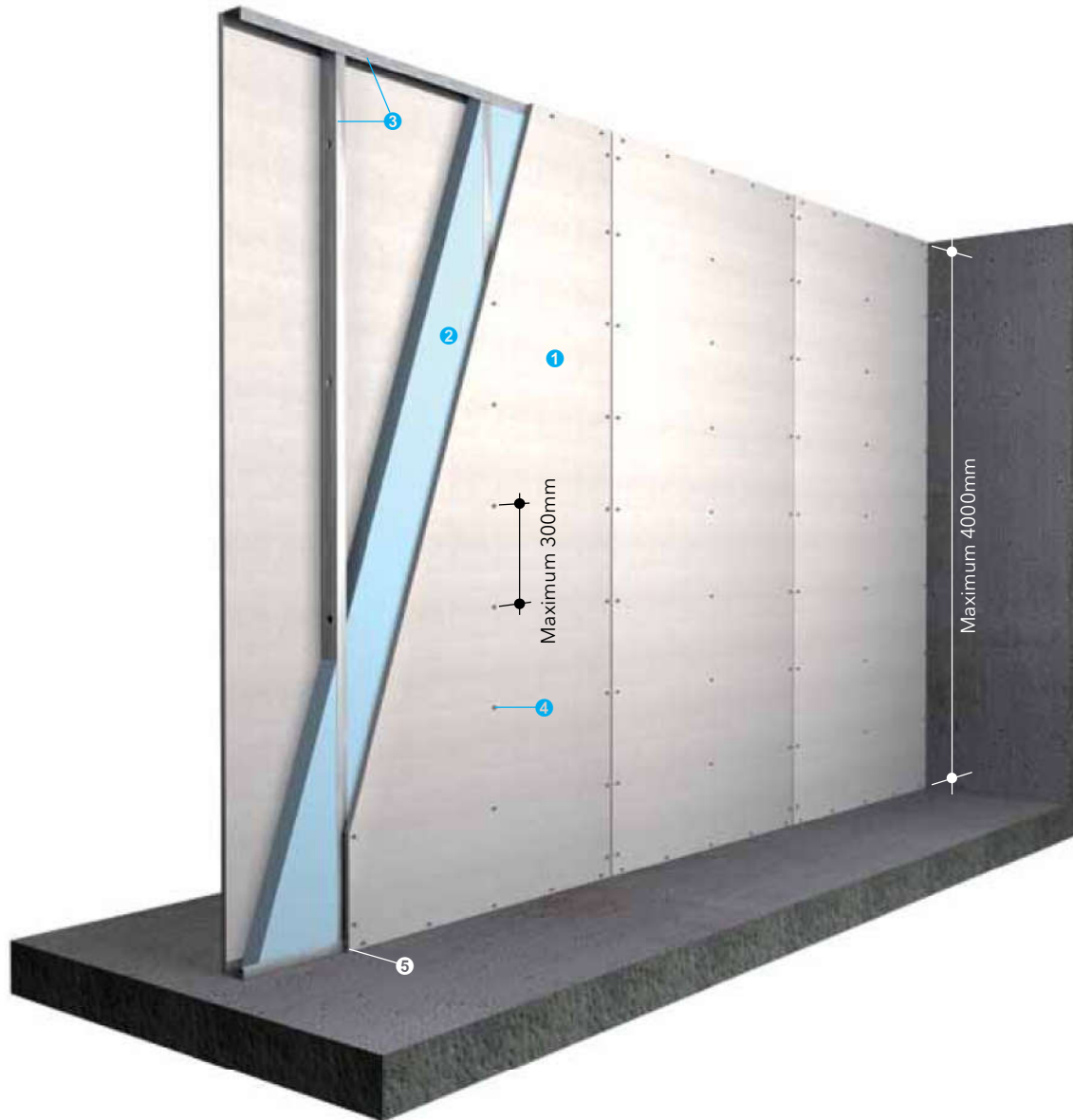

- ① One layer of PROMATECT® 100 board 20mm thick at both sides of steel studs
- ② Cavity infill if required to improve acoustic or thermal insulation
- ③ Galvanised steel studs, measurements in accordance with Studs Tables on [page 94](#) (allow appropriate expansion at top horizontal track)
- ④ 45mm long self-tapping screws at maximum 300mm centres
- ⑤ Caulk all perimeter gaps with PROMASEAL®-A Acrylic Sealant to achieve the required fire resistance and/or acoustic performance

See [page 60](#) and [61](#) for bottom and top track fixings; [pages 67](#) to [71](#) for details of wall head, wall base, wall junction and wall movement joints.

### Vertical sheeting (Above 3000mm) / Non loadbearing

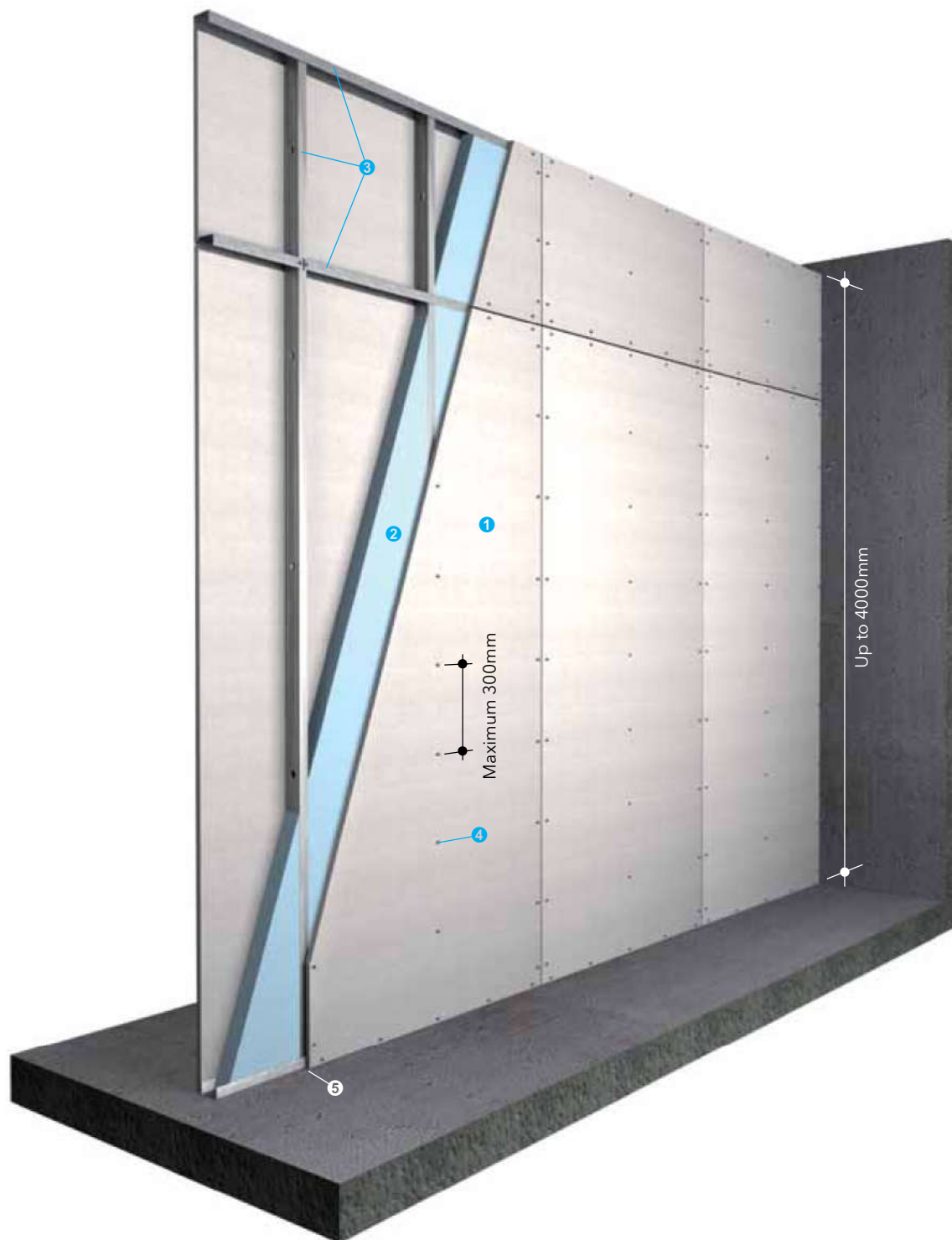

- ① One layer of PROMATECT® 100 board 20mm thick at both sides of steel studs
- ② Cavity infill if required to improve acoustic or thermal insulation
- ③ Galvanised steel studs, measurements in accordance with Studs Tables on [page 94](#) (allow appropriate expansion at top horizontal track)
- ④ 45mm long self-tapping screws at maximum 300mm centres
- ⑤ Caulk all perimeter gaps with PROMASEAL®-A Acrylic Sealant to achieve the required fire resistance and/or acoustic performance

See [page 60](#) and [61](#) for bottom and top track fixings; [pages 67](#) to [71](#) for details of wall head, wall base, wall junction and wall movement joints.

### Horizontal sheeting with nogging joint / Non loadbearing

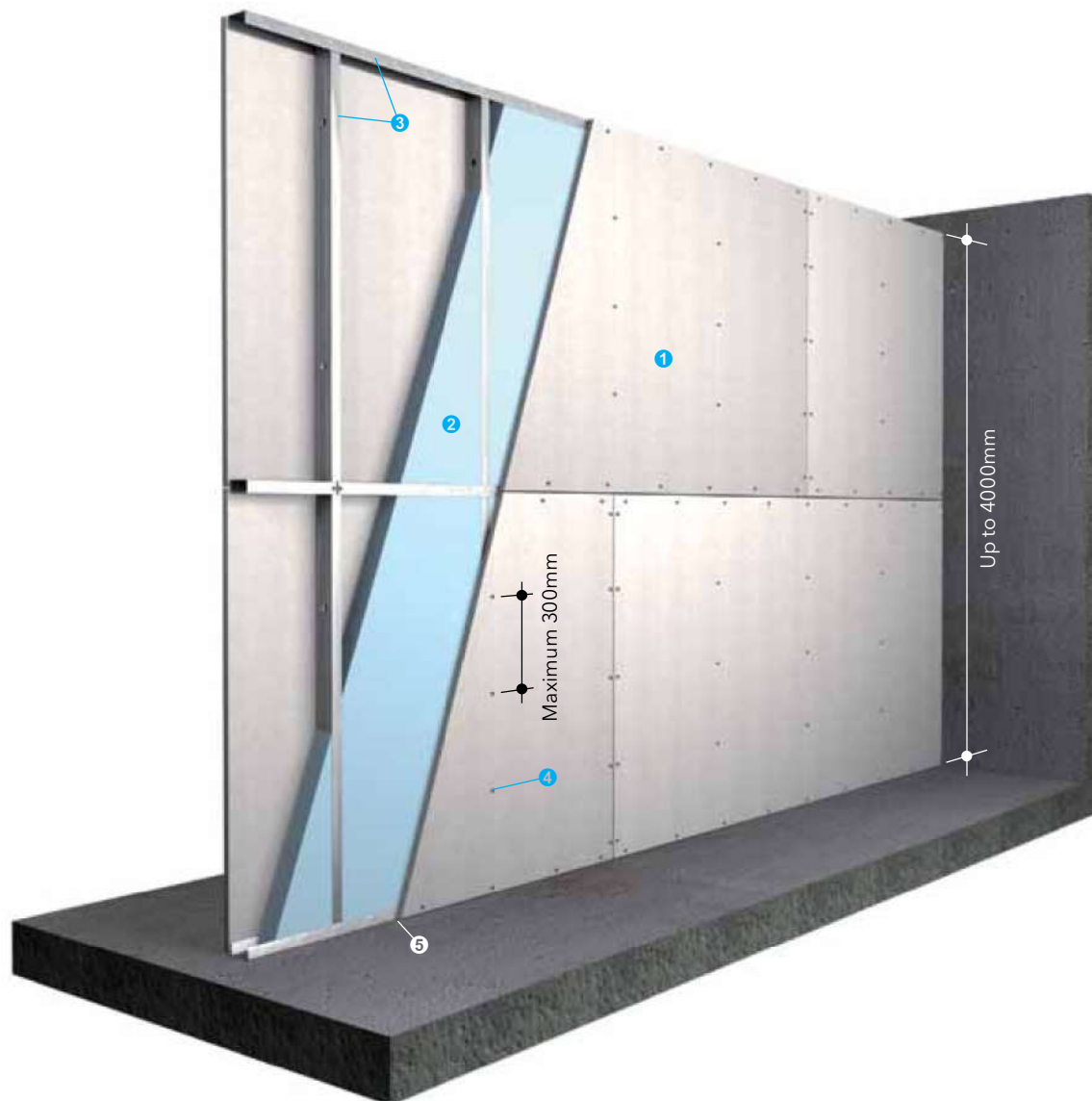

- ❶ One layer of PROMATECT® 100 board 20mm thick at both sides of steel studs
- ❷ Cavity infill if required to improve acoustic or thermal insulation
- ❸ Galvanised steel studs, measurements in accordance with Studs Tables on [page 94](#) (allow appropriate expansion at top horizontal track), refer to table below for the distance between stud
- ❹ 45mm long self-tapping screws at maximum 300mm centres
- ❺ Caulk all perimeter gaps with PROMASEAL®-A Acrylic Sealant to achieve the required fire resistance and/or acoustic performance

See [page 60](#) and [61](#) for bottom and top track fixings; [pages 67](#) to [71](#) for details of wall head, wall base, wall junction and wall movement joints.

### Horizontal sheeting with strip joint / Non loadbearing

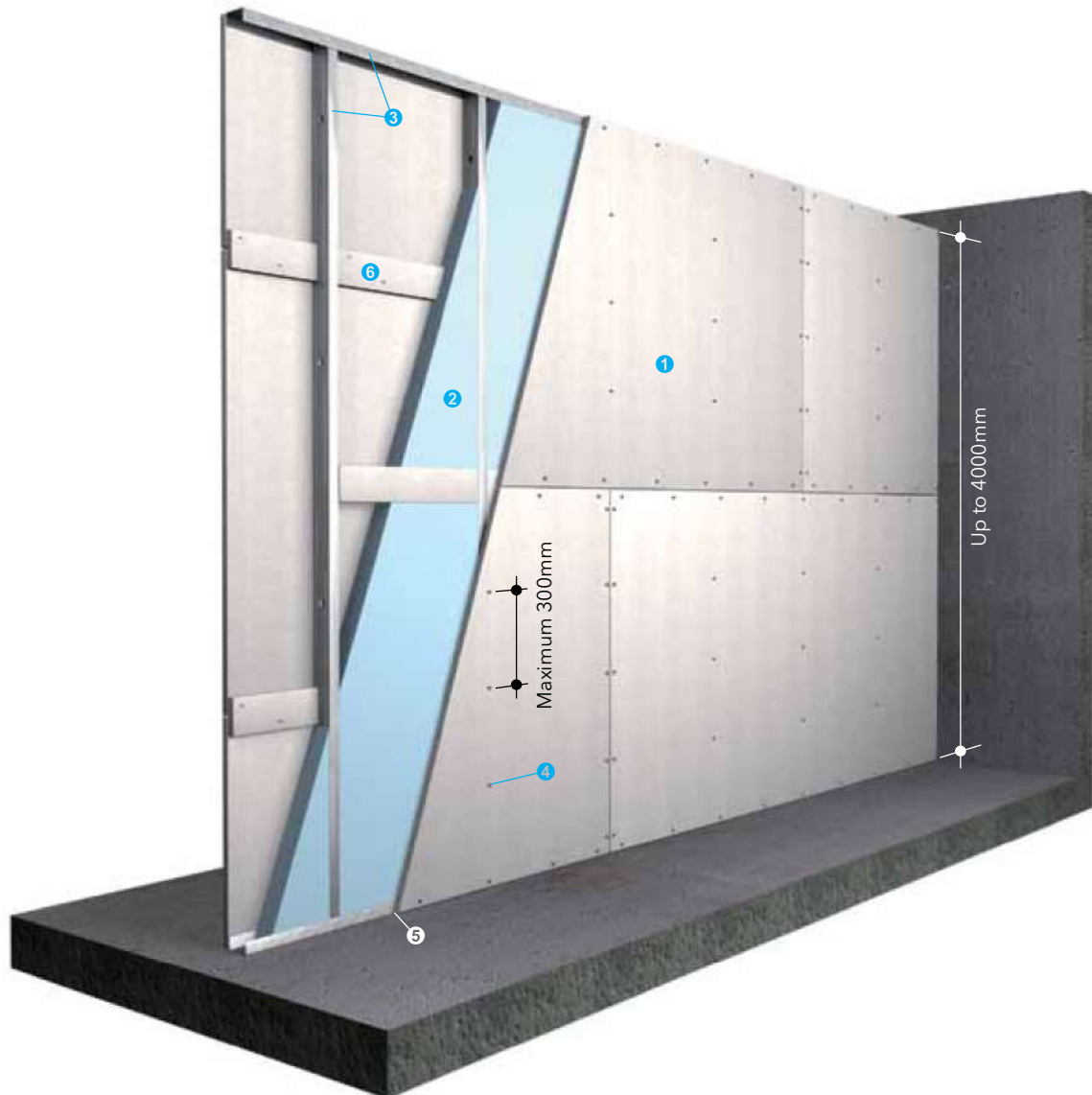

- ① One layer of PROMATECT® 100 board 20mm thick at both sides of steel studs
- ② Cavity infill if required to improve acoustic or thermal insulation
- ③ Galvanised steel studs, measurements in accordance with Studs Tables on [page 94](#) (allow appropriate expansion at top horizontal track)
- ④ 45mm long self-tapping screws at maximum 300mm centres
- ⑤ Caulk all perimeter gaps with PROMASEAL®-A Acrylic Sealant to achieve the required fire resistance and/or acoustic performance
- ⑥ 20mm thick PROMATECT® 100 cover strips at horizontal board joint

See [page 60 and 61](#) for bottom and top track fixings; [pages 67 to 71](#) for details of wall head, wall base, wall junction and wall movement joints.



### Horizontal sheeting with channel joint / Non loadbearing

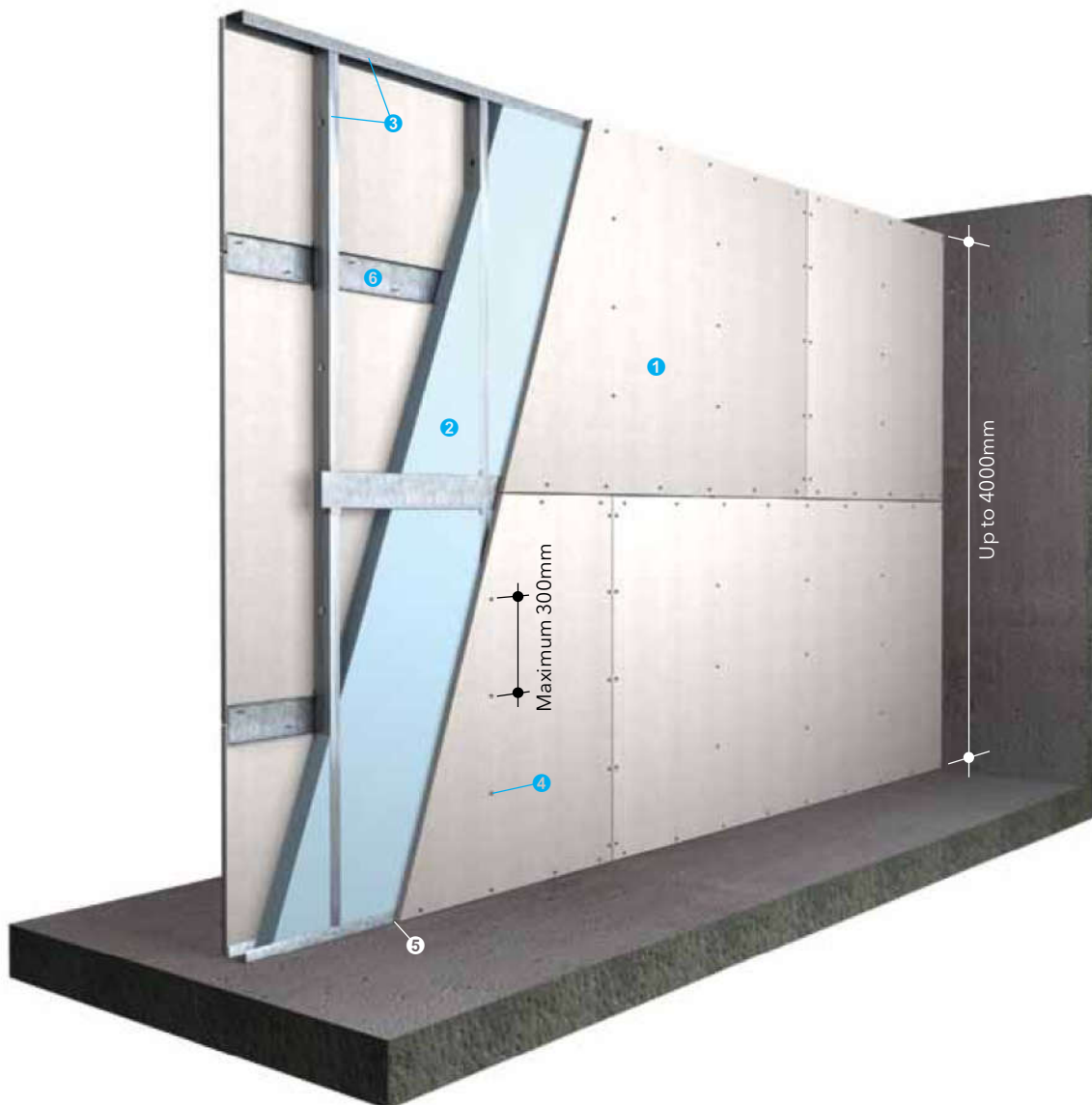

- ① One layer of PROMATECT® 100 board 20mm thick at both sides of steel studs
- ② Cavity infill if required to improve acoustic or thermal insulation
- ③ Galvanised steel studs, measurements in accordance with Studs Tables on page 94 (allow appropriate expansion at top horizontal track)
- ④ 45mm long self-tapping screws at maximum 300mm centres
- ⑤ Caulk all perimeter gaps with PROMASEAL®-A Acrylic Sealant to achieve the required fire resistance and/or acoustic performance
- ⑥ Fixing channel 100mm x 10mm x 0.9mm thick

See page 60 and 61 for bottom and top track fixings; pages 67 to 71 for details of wall head, wall base, wall junction and wall movement joints.



Fire resistance	FRL	-/240/240
	Standard	AS 1530: Part 4: 2014
	Approval	BRE P106900-1005
Acoustic	STC, R <sub>w</sub>	See acoustic table below
	Standard	ISO 140: Part 3: 1996 ISO 717: Part 1: 1996
	Predicted assessment	Marshall Day 13th October 2016
Construction	Maximum height*	5000mm
	Maximum length	Unlimited
	Partition thickness	From 164mm
	Partition mass*	From 70kg/m <sup>2</sup>

- ① Two layer of PROMATECT® 100 board 20mm thick on both sides of steel studs
- ② Galvanised steel studs, measurements in accordance with Studs Tables on page 94 (allow appropriate expansion at top horizontal track)
- ③ 32mm long self-tapping screws at maximum 300mm centres  
50mm long self-tapping screws at maximum 200mm centres to fixed second layer to frame  
40mm long stitching screws at maximum 200mm centres to fixed second layer to first layer
- ④ 40mm long M10 masonry anchors at nominal 500mm centres
- ⑤ Caulk all perimeter gaps with PROMASEAL®-A Acrylic Sealant to achieve the required fire resistance and/or acoustic performance

See page 60 and 61 for bottom and top track fixings; pages 67 to 71 for details of wall head, wall base, wall junction and wall movement joints.

#### Acoustic Table

Stud depth	92mm	150mm
Cavity infill	# STC / R <sub>w</sub> (C <sub>r</sub> )	
a) Nil	53/54dB (-7)	53/55dB (-6)
b) Bradford R2.0 Soundscreen 50mm x 32kg/m <sup>3</sup>	55/58dB (-6)	55/59dB (-6)
c) Bradford R2.0 Soundscreen 75mm x 32kg/m <sup>3</sup>	55/58dB (-6)	55/59dB (-6)
d) R1.8 Pink Wall Batts 60mm x 9kg/m <sup>3</sup>	55/58dB (-6)	55/59dB (-6)

NOTE: Above values are predicted figures. # Margin of error is generally within ±3dB

### Vertical sheeting (Below 3000mm) / Non loadbearing

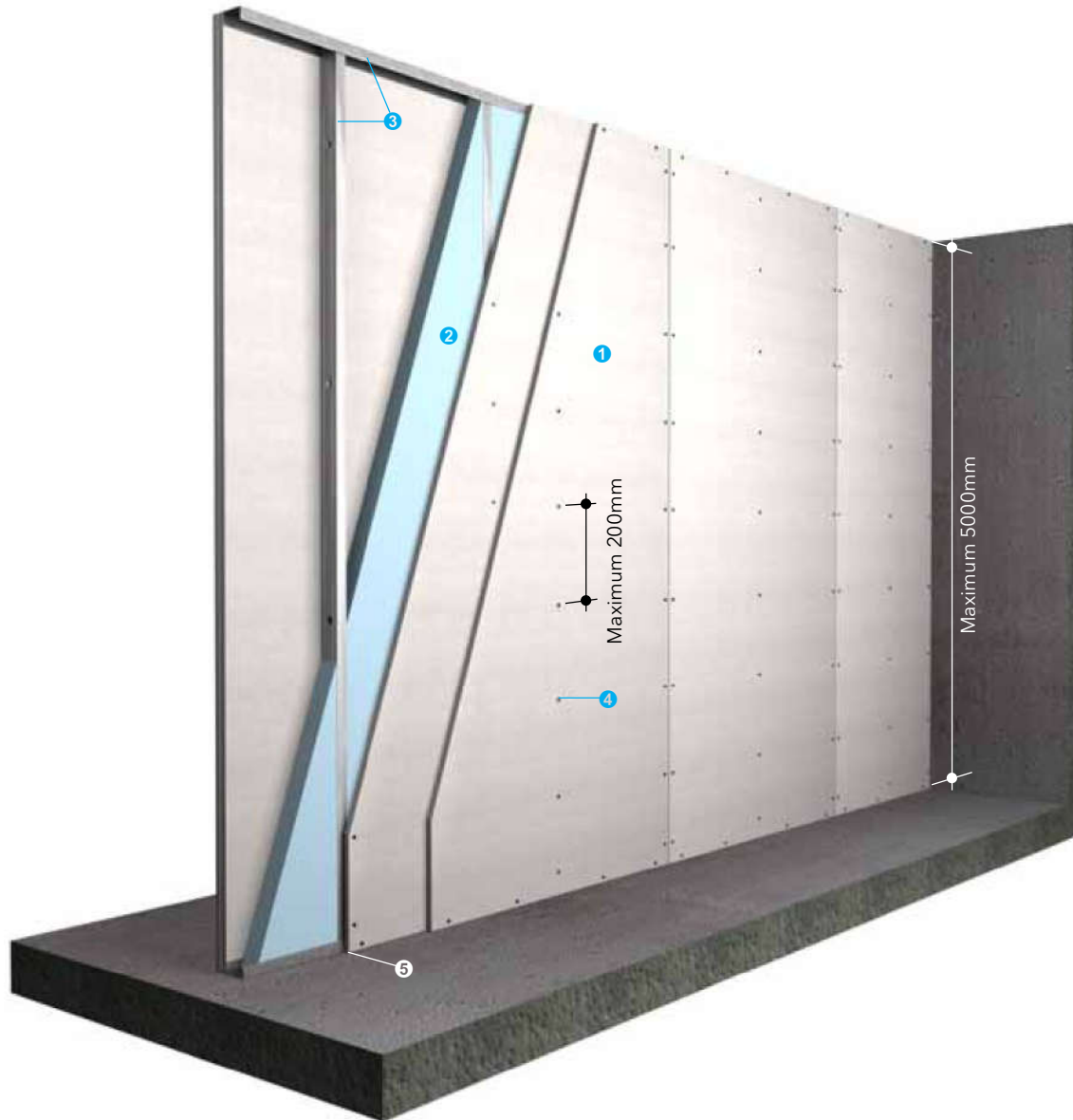

- ① Two layer of PROMATECT® 100 board 20mm thick on both sides of steel studs
- ② Cavity infill if required to improve acoustic or thermal insulation
- ③ Galvanised steel studs, measurements in accordance with Studs Tables on [page 94](#) (allow appropriate expansion at top horizontal track)
- ④ 32mm long self-tapping screws at maximum 300mm centres  
50mm long self-tapping screws at maximum 200mm centres to fixed second layer to frame  
40mm long stitching screws at maximum 200mm centres to fixed second layer to first layer
- ⑤ Caulk all perimeter gaps with PROMASEAL®-A Acrylic Sealant to achieve the required fire resistance and/or acoustic performance

See [page 60](#) and [61](#) for bottom and top track fixings; [pages 67](#) to [71](#) for details of wall head, wall base, wall junction and wall movement joints.

### Vertical sheeting (Above 3000mm) / Non loadbearing

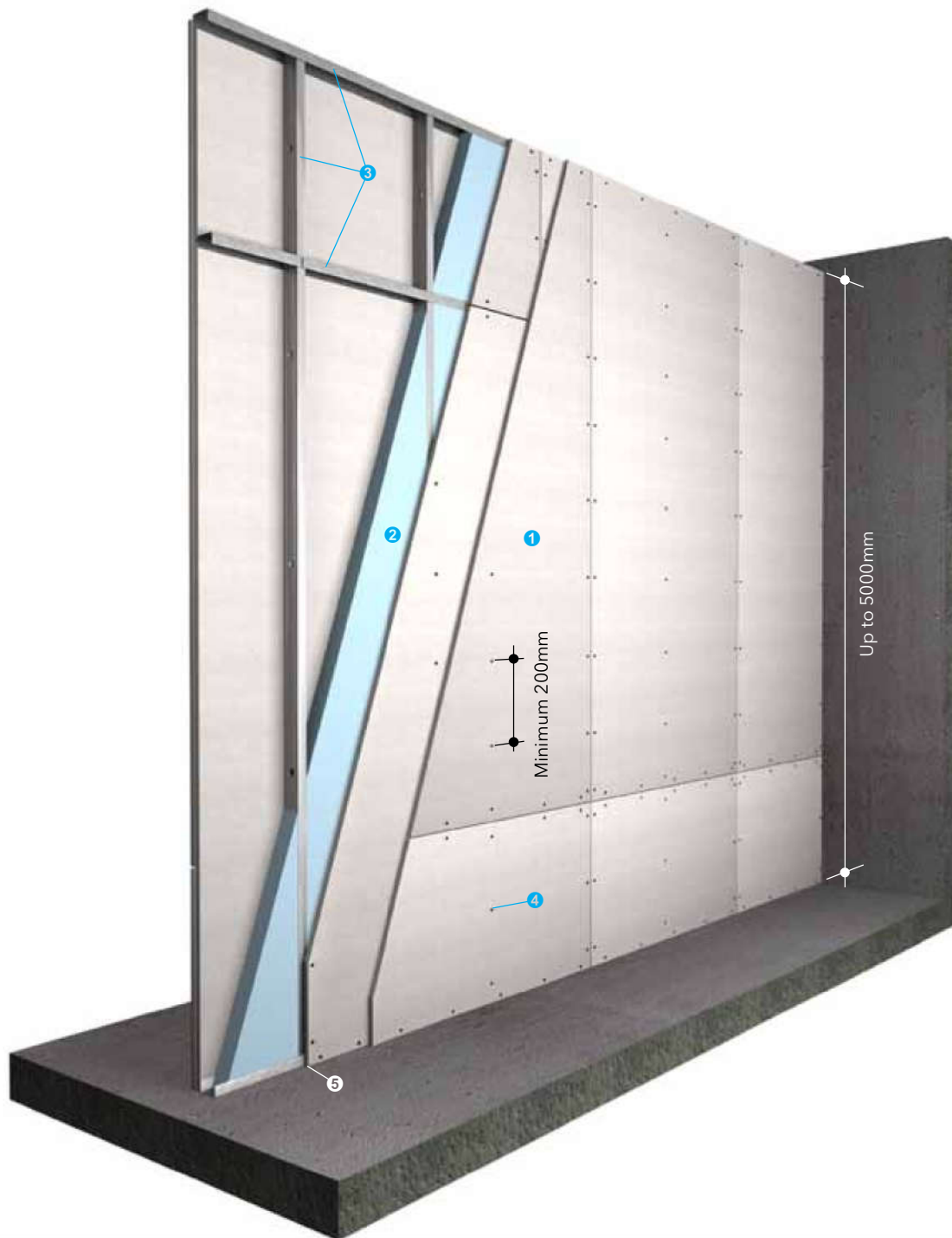

- ① Two layer of PROMATECT® 100 board 20mm thick on both sides of steel studs
- ② Cavity infill if required to improve acoustic or thermal insulation
- ③ Galvanised steel studs, measurements in accordance with Studs Tables on [page 94](#) (allow appropriate expansion at top horizontal track)
- ④ 32mm long self-tapping screws at maximum 300mm centres  
50mm long self-tapping screws at maximum 200mm centres to fixed second layer to frame  
40mm long stitching screws at maximum 200mm centres to fixed second layer to first layer
- ⑤ Caulk all perimeter gaps with PROMASEAL®-A Acrylic Sealant to achieve the required fire resistance and/or acoustic performance

See [page 60](#) and [61](#) for bottom and top track fixings; [pages 67](#) to [71](#) for details of wall head, wall base, wall junction and wall movement joints.

### Horizontal sheeting with noggling joint / Non loadbearing

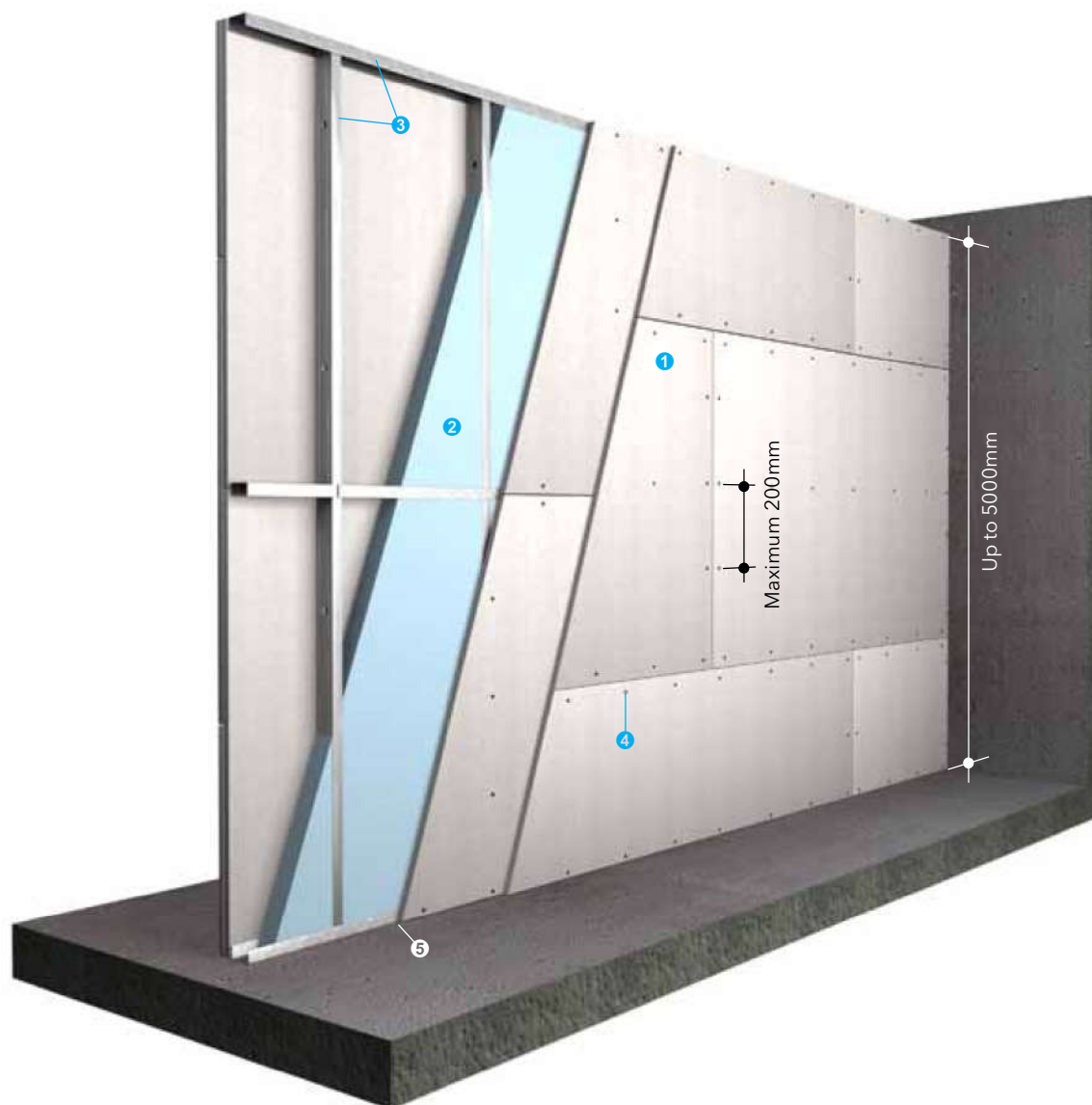

- ❶ Two layer of PROMATECT® 100 board 20mm thick on both sides of steel studs
- ❷ Cavity infill if required to improve acoustic or thermal insulation
- ❸ Galvanised steel studs, measurements in accordance with Studs Tables on [page 94](#) (allow appropriate expansion at top horizontal track), refer to table below for the distance between stud
- ❹ 32mm long self-tapping screws at maximum 300mm centres  
50mm long self-tapping screws at maximum 200mm centres to fixed second layer to frame  
40mm long stitching screws at maximum 200mm centres to fixed second layer to first layer
- ❺ Caulk all perimeter gaps with PROMASEAL®-A Acrylic Sealant to achieve the required fire resistance and/or acoustic performance

See [page 60](#) and [61](#) for bottom and top track fixings; [pages 67](#) to [71](#) for details of wall head, wall base, wall junction and wall movement joints.

### Horizontal sheeting with strip joint / Non loadbearing

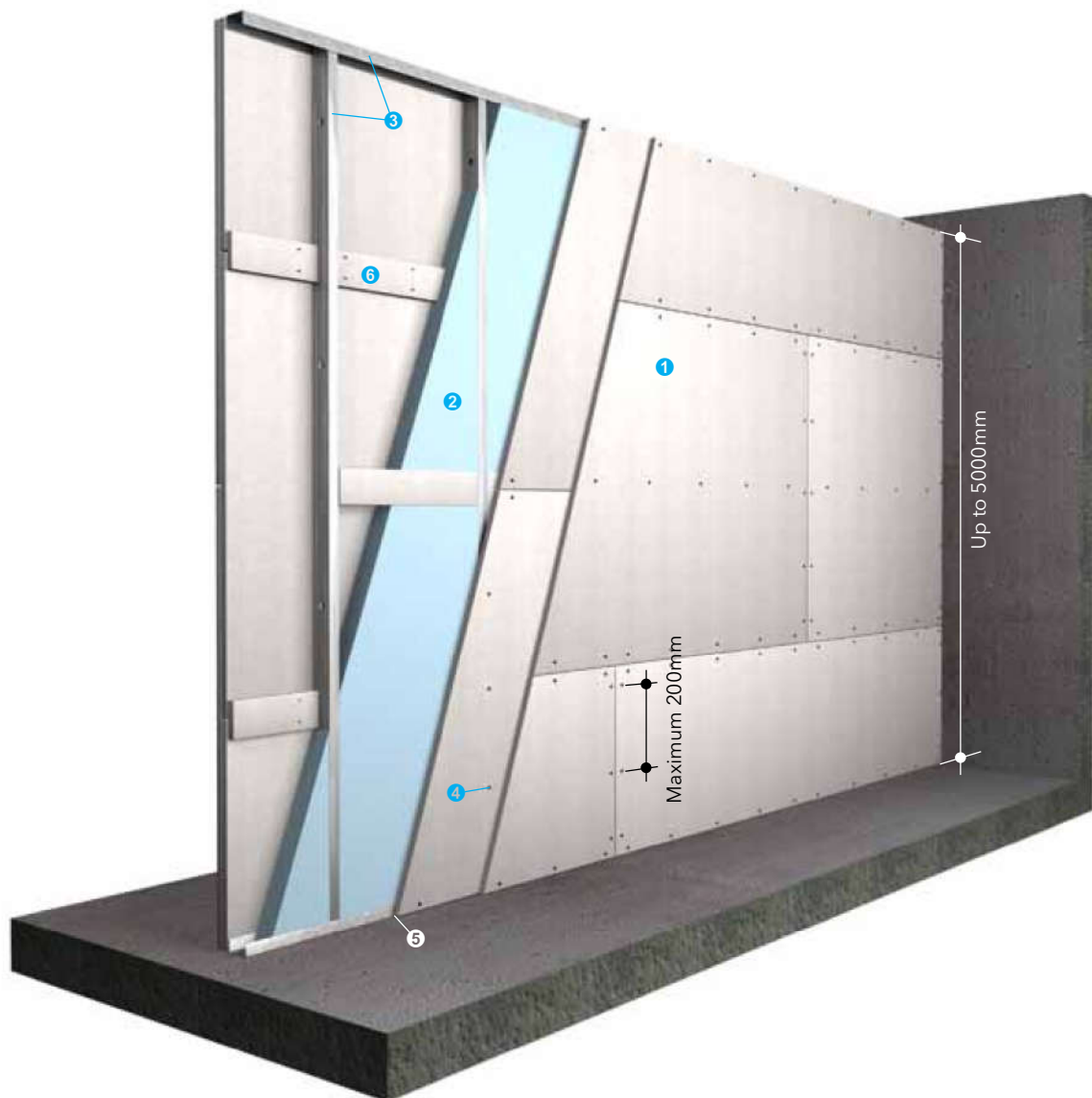

- ① Two layer of PROMATECT® 100 board 20mm thick on both sides of steel studs
- ② Cavity infill if required to improve acoustic or thermal insulation
- ③ Galvanised steel studs, measurements in accordance with Studs Tables on [page 94](#) (allow appropriate expansion at top horizontal track)
- ③ 32mm long self-tapping screws at maximum 300mm centres  
50mm long self-tapping screws at maximum 200mm centres to fixed second layer to frame  
40mm long stitching screws at maximum 200mm centres to fixed second layer to first layer
- ⑤ Caulk all perimeter gaps with PROMASEAL®-A Acrylic Sealant to achieve the required fire resistance and/or acoustic performance
- ⑥ 20mm thick PROMATECT® 100 cover strips at horizontal board joint

See [page 60](#) and [61](#) for bottom and top track fixings; [pages 67 to 71](#) for details of wall head, wall base, wall junction and wall movement joints.

### Horizontal sheeting with channel joint / Non loadbearing

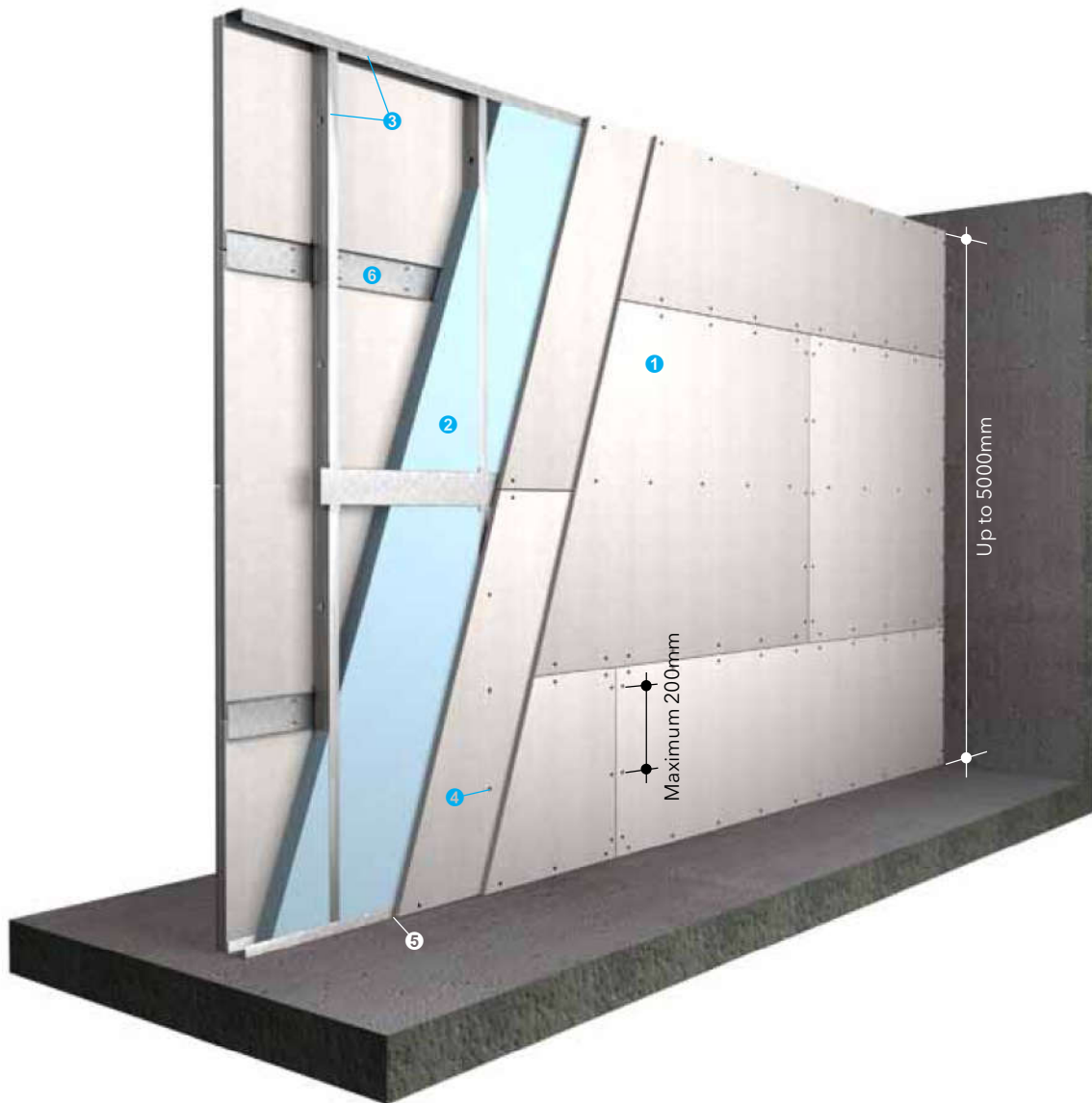

- ❶ Two layer of PROMATECT® 100 board 20mm thick on both sides of steel studs
- ❷ Cavity infill if required to improve acoustic or thermal insulation
- ❸ Galvanised steel studs, measurements in accordance with Studs Tables on [page 94](#) (allow appropriate expansion at top horizontal track)
- ❹ 32mm long self-tapping screws at maximum 300mm centres  
50mm long self-tapping screws at maximum 200mm centres to fixed second layer to frame  
40mm long stitching screws at maximum 200mm centres to fixed second layer to first layer
- ❺ Caulk all perimeter gaps with PROMASEAL®-A Acrylic Sealant to achieve the required fire resistance and/or acoustic performance
- ❻ Fixing channel 100mm x 10mm x 0.9mm thick

See [pages 60 and 61](#) for bottom and top track fixings; [pages 67 to 71](#) for details of wall head, wall base, wall junction and wall movement joints.

The following are standard Architectural Specifications for single steel stud partition systems using PROMATECT® 100. The designer must determine the suitability of the design to the application and requirements before undertaking or constructing any works relating to the specifications and where in doubt should obtain the advice of a suitably qualified engineer.

---

**Fire attack from either side / non loadbearing**

---

Up to 240 minute fire resistance, integrity and insulation in accordance with the criteria of AS 1530:Part 4: 2014<sup>(1)</sup>. Lateral load of up to 0.25kPa.

---

**Acoustic performance**

---

The partition system shall have a Weighted Sound Reduction Index up to  $R_w$  50.

---

**Supporting structure**

---

Care should be taken that any structural element that the partition system is supported from, e.g. steel stud or perimeter steel channel, has fire resistance equal to or greater than FRL of the partition.

---

**Lining boards**

---

One or two<sup>(2)</sup> layer on either side of 15mm or 20mm<sup>(3)</sup> thick PROMATECT® 100 PromaX® mineral boards as manufactured by Promat International (Asia Pacific) Ltd. All joints to be coincident with steel framing. Standard board dimension 1200mm x 2500mm x 20mm thick.

---

**Fixing**

---

Galvanised steel frame made of ceiling and floor tracks will be secured to the floor, ceiling and walls with 40mm long M6 masonry anchors at 500mm centres. Vertical steel studs are then friction fitted into the tracks at 600mm centres for boards to be installed with long edge vertically and at 625mm centres for boards to be installed with long edge horizontally. Adequate clearance for vertical expansion will be allowed at the ceiling/top track. No clearance is necessary at the bottom track. See table below for steel size and clearance at top track for given partition height.

Horizontal noggings, cut out of the steel track material will be friction fitted between the steel studs to coincide with horizontal joints between boards.



### Studs table

Partitions lined with 20mm thick PROMATECT® 100 using studs at 600mm centres, 0.25kPa, minimum two rows of nogging at 1200mm centres. Contact Promat for stud tables for 60 and 240 minute walls.

Maximum partition height	Stud depth	Maximum stud thickness	Maximum partition thickness	Top track	Clearance at top track
4000mm	64mm	0.55mm	104mm	65 x 46 x 0.7mm	20mm

20mm thick PROMATECT® 100 boards will be screw-fixed to the frame with 35mm x No.8 self-tapping screws at maximum 300mm centres.

### Tests & standards

Along with all material tests the complete system along with the framing is tested in accordance with the criteria of BS 476: Part 476: 1987 and/or AS 1530: Part 4: 2014<sup>(1)</sup>. The partition system should meet the requirements specified in NCC Specification C1.8 or S6C1 for static, dynamic and indentation load tests as specified under Clauses 3.1, 3.2 and 3.4 or S6C3, S6C4 or S6C5

### Jointing

Plain butt joints between machined edges of boards. <sup>(4)</sup>  
 Joints filled in preparation for painting. <sup>(5)</sup>  
 Joints filled and taped in preparation for decoration. <sup>(6)</sup>

### Follow-on trades

Surface of boards to be prepared for painting/plastering/tiling<sup>(5)</sup> in accordance with manufacturer's recommendations.

### NOTES:

- (1), (2), (3), (4), (5), (6) delete as appropriate.
- All perimeter gaps caulked with PROMASEAL®-A Acrylic Sealant.



Fire resistance	FRL	-/120/120
	Standard	AS 1530: Part 4: 2005
	Approval	WFRA 45833
Acoustic	STC, R <sub>w</sub>	See acoustic table below
	Standard	ISO 140: Part 3: 1996 ISO 717: Part 1: 1996
	Predicted assessment	Marshall Day 18th October 2006
Construction	Maximum height*	3000mm
	Maximum length	Unlimited
	Partition thickness	From 178mm
	Partition mass*	From 36kg/m <sup>2</sup>

\* Details for walls above 3000mm high are available on request

- ① One layer of PROMATECT® 100 board 20mm thick at both sides of steel studs
- ② Galvanised steel studs, measurements in accordance with Studs Table on page 98 (allow appropriate expansion at top horizontal track)
- ③ 45mm long No.8 self-tapping screws at maximum 300mm centres
- ④ 40mm long M6 masonry anchors at nominal 500mm centres
- ⑤ Caulk all perimeter gaps with PROMASEAL®-A Acrylic Sealant to achieve the required fire resistance and/or acoustic performance
- ⑥ A minimum 10mm air space to be left between the frames to ensure best acoustic performance

### Acoustic Table

Stud depth	64mm	76mm	92mm	150mm
Cavity infill	# STC / R <sub>w</sub> (C <sub>tr</sub> )			
a) Nil	40/44dB (-6)	41/45dB (-6)	43/46dB (-6)	47/49dB (-7)
b) Glasswool partition batts 50mm x 32kg/m <sup>3</sup>	58/59dB (-8)	58/60dB (-7)	58/60dB (-6)	58/61dB (-5)
c) Glasswool partition batts 75mm x 32kg/m <sup>3</sup>	59/59dB (-7)	59/60dB (-7)	59/61dB (-7)	59/62dB (-6)
d) ASB3 / TSB3 Polyester batts 60mm x 8kg/m <sup>3</sup>	56/57dB (-6)	56/58dB (-6)	56/59dB (-6)	56/59dB (-5)
e) Soundscreen™ R1.6 Batts 60mm	57/58dB (-7)	57/59dB (-7)	57/59dB (-6)	57/60dB (-5)

NOTE: Above values are predicted figures. # Margin of error is generally within ±3dB

### Horizontal sheeting with strip joint / Non loadbearing

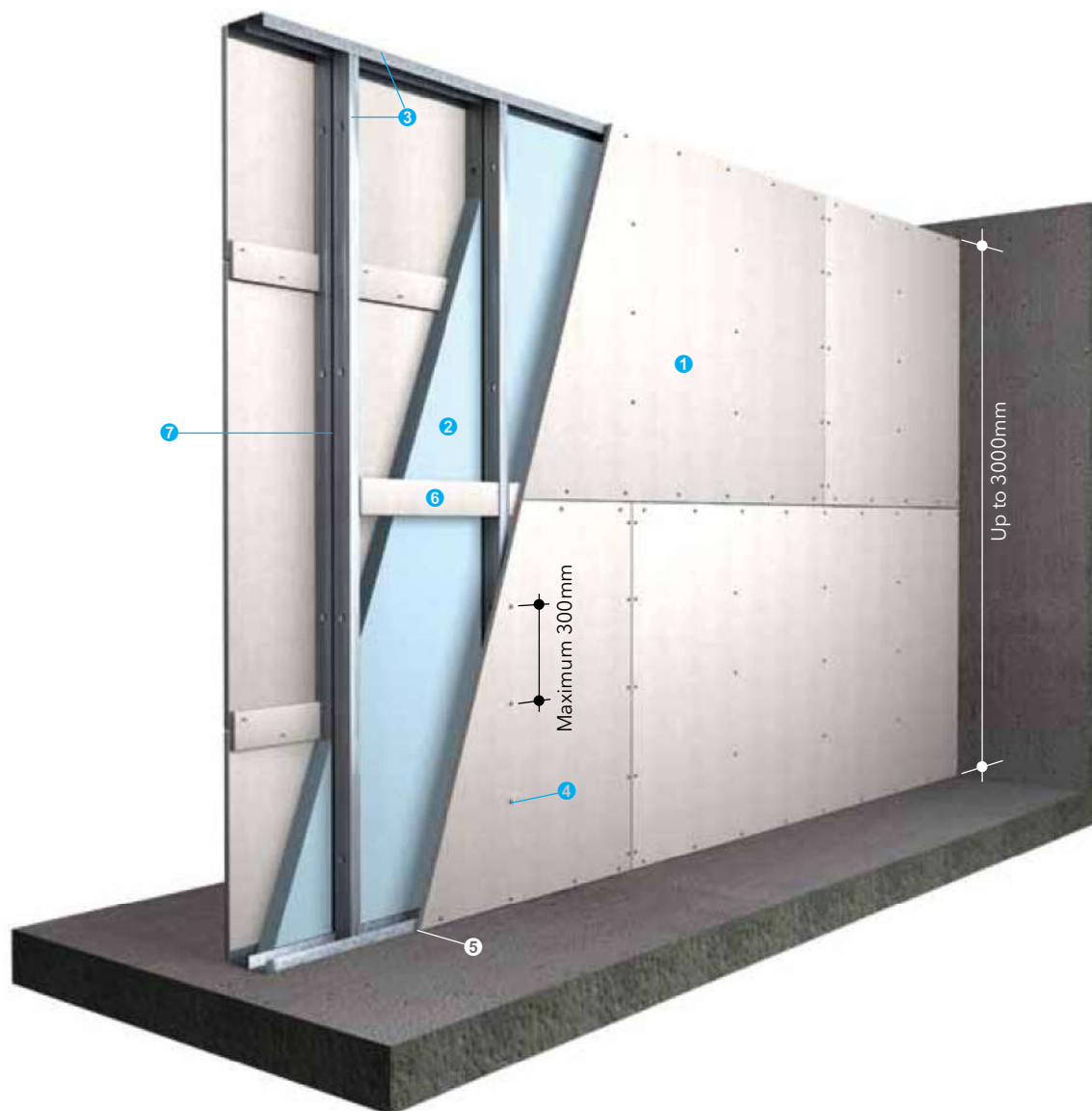

- ❶ One layer of PROMATECT® 100 board 20mm thick at both sides of steel studs
- ❷ Cavity infill if required to improve acoustic or thermal insulation
- ❸ Galvanised steel studs, measurements in accordance with Studs Table on [page 98](#) (allow appropriate expansion at top horizontal track)
- ❹ 45mm long No.8 self-tapping screws at maximum 300mm centres
- ❺ Caulk all perimeter gaps with PROMASEAL®-A Acrylic Sealant to achieve the required fire resistance and/or acoustic performance
- ❻ 20mm thick PROMATECT® 100 cover strips
- ❼ A minimum 10mm air space to be left between the frames to ensure best acoustic performance

See [pages 60 and 61](#) for bottom and top track fixings; [pages 67 to 71](#) for details of wall head, wall base, wall junction and wall movement joints.

The following are standard Architectural Specifications for double steel stud partition systems using PROMATECT® 100. The designer must determine the suitability of the design to the application and requirements before undertaking or constructing any works relating to the specifications and where in doubt should obtain the advice of a suitably qualified engineer.

---

**Fire attack from either side / non loadbearing**

---

Up to 120 minute fire resistance, integrity and insulation in accordance with the criteria of AS1530: Part 4: 2014<sup>(1)</sup>.

---

**Acoustic performance**

---

The partition system shall have a Weighted Sound Reduction Index up to  $R_w$  60.

---

**Supporting structure**

---

Care should be taken that any structural element that the partition system is supported from, e.g. steel stud or perimeter steel channel, has a fire resistance equal to or greater than 120 minutes.

---

**Lining boards**

---

Single layer each side 20mm thick PROMATECT® PromaX® mineral boards as manufactured by Promat International (Asia Pacific) Ltd. All joints to be coincident with steel framing. Standard board dimension 1200mm x 2500mm x 20mm thick.

---

**Fixing**

---

2 rows of galvanised steel framing made of ceiling and floor tracks will be secured to the floor, ceiling and walls with 40mm long M6 masonry anchors at 500mm centres. An air gap of 10mm minimum will be provided between the two rows of the galvanised steel frame. Vertical steel studs are then friction fitted into each of the two rows tracks at 600mm centres for boards to be installed vertically and at 625mm centres for boards to be installed horizontally. Adequate clearance for vertical expansion will be allowed at the ceiling/top track. No clearance is necessary at the bottom track. See table below for steel size and clearance at top track for given partition height.

Horizontal noggings, cut out of the steel track material will be friction fitted between the steel studs.

---

**Tests & standards**

---

Along with all material tests the complete system along with the framing is tested in accordance with the criteria of AS 1530: Part 4: 2014<sup>(1)</sup>.

---

**Jointing**

---

Plain butt joints between machined edges of boards. <sup>(2)</sup>

Joints filled in preparation for painting. <sup>(3)</sup>

Joints filled and taped in preparation for decoration. <sup>(4)</sup>

---

**Follow-on trades**

---

Surface of boards to be prepared for painting/plastering/tiling<sup>(5)</sup> in accordance with manufacturer's recommendations.

**NOTES:**

- (1), (2), (3), (4), (5) delete as appropriate.
- All perimeter gaps caulked with PROMASEAL®-A Acrylic Sealant.

### Fire attack from both sides / Non loadbearing



Fire resistance	FRL	-/90/90 90/90/90
	Standard	AS 1530: Part 4: 2014
	Approval	BRANZ FR6112
Acoustic	# STC # R <sub>w</sub>	35dB 39dB
	Standard	ISO 140: Part 3: 1996 ISO 717: Part 1: 1996
	Predicted assessment	Marshall Day 18th October 2006
Construction	Maximum height	4000mm
	Maximum length	Unlimited
	Partition thickness	From 130mm
	Partition mass*	From 37kg/m <sup>2</sup>

# Margin of error is generally within ±3dB

- ① One layer of PROMATECT® 100 board 20mm thick
- ② Timber studs 90mm deep x 45mm wide at nominal 600mm or 625mm centres
- ③ 75mm long No.8 woodscrews or 75mm long nails at 200mm nominal centres
- ④ M12 expanding anchors at 500mm maximum centres
- ⑤ Caulk all perimeter gaps with PROMASEAL®-A Acrylic Sealant to achieve the required fire resistance and/or acoustic performance

For 60/60/60 use same framing as above and substitute 15mm PROMATECT® 100 boards on each face

### Movement joints

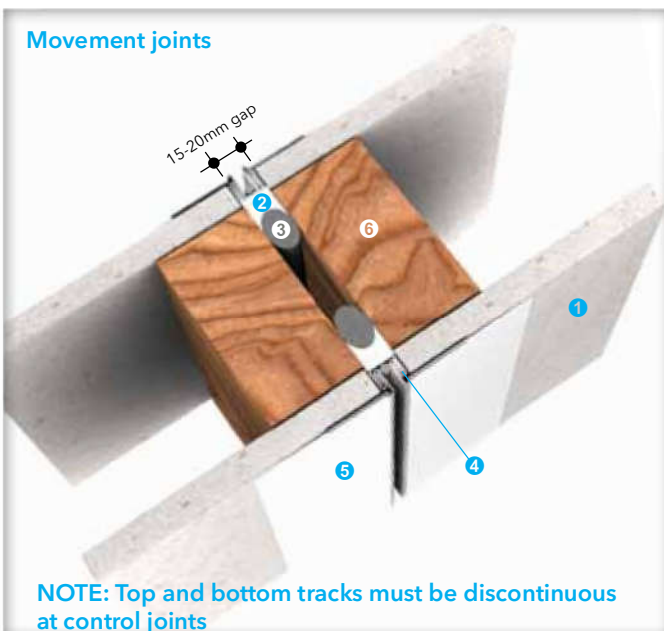

NOTE: Top and bottom tracks must be discontinuous at control joints

- ① PROMATECT® 100 board
- ② PROMASEAL®-A Acrylic Sealant
- ③ Backing rod
- ④ RONDO P35 or equivalent control joint profile
- ⑤ Finish surface as per external angles
- ⑥ Timber studs 90mm x 45mm at 625mm centres

### Vertical sheeting / Non loadbearing

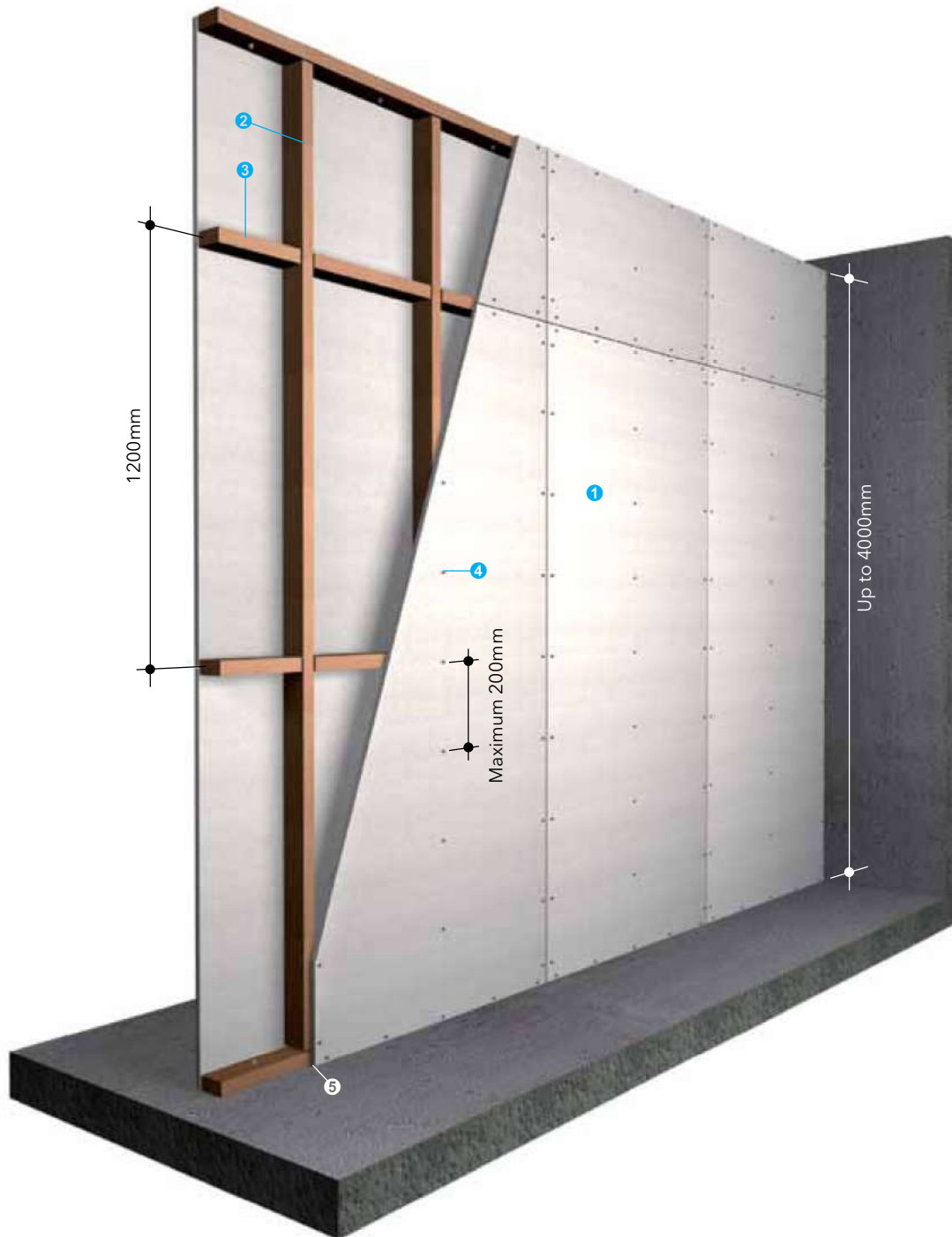

- ❶ One layer of PROMATECT® 100 board 20mm thick
- ❷ Vertical studs at 600mm centres
- ❸ Horizontal noggings at 1250mm centres
- ❹ 75mm x No.8 woodscrews at 200mm nominal centres or 75mm long nails at 200mm centres
- ❺ Caulk all perimeter gaps with PROMASEAL®-A Acrylic Sealant to achieve the required fire resistance and/or acoustic performance

See page 63 for fixings of cross noggings and floor plate; page 99 for detail of wall movement joints.

### Horizontal sheeting with nogging joint / loadbearing

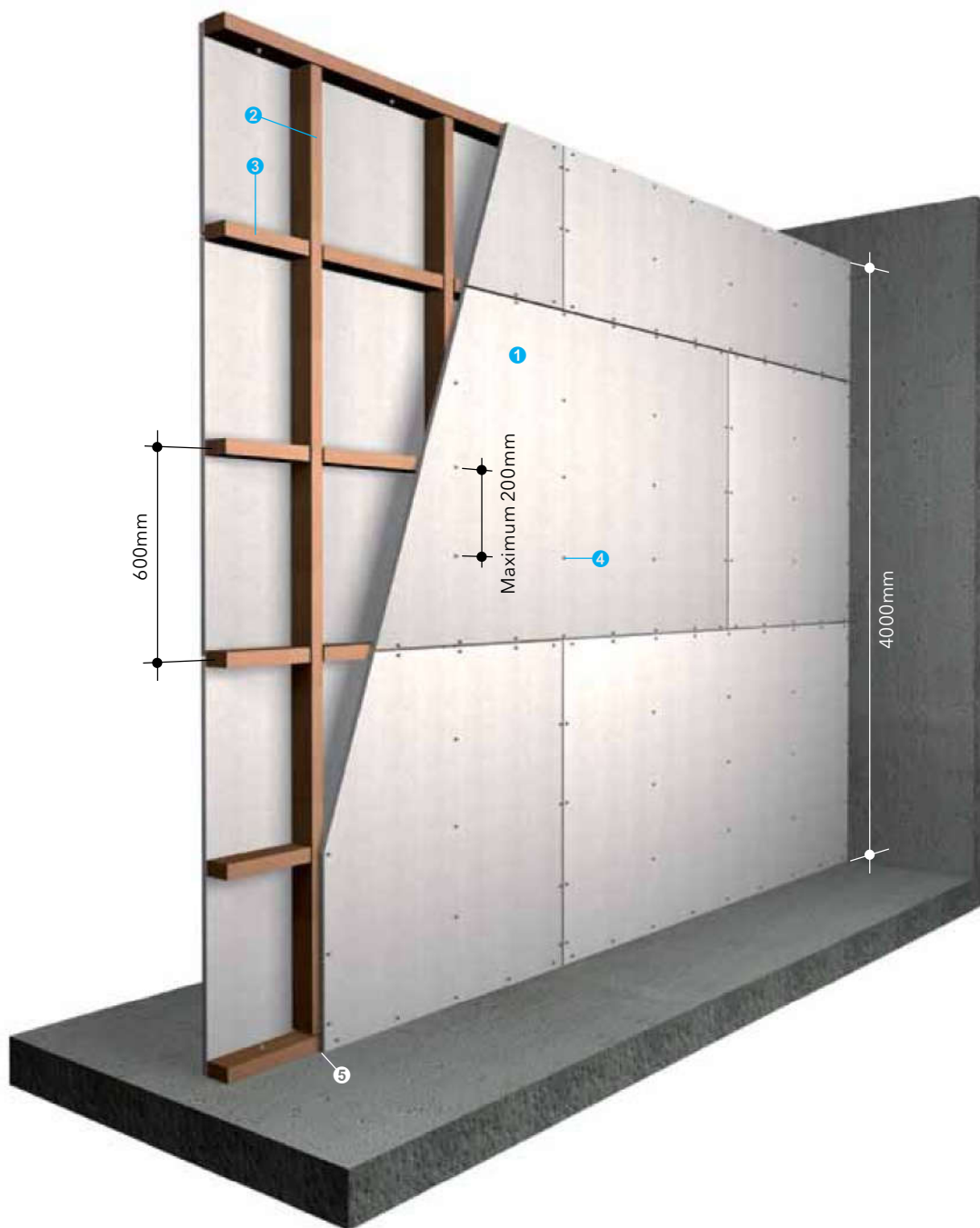

- ① One layer of PROMATECT® 100 board 20mm thick
- ② Vertical studs at 625mm centres
- ③ Horizontal nogging at 600mm centres
- ④ 75mm long No.8 woodscrews at 200mm nominal centres
- ⑤ Caulk all perimeter gaps with PROMASEAL®-A Acrylic Sealant to achieve the required fire resistance and/or acoustic performance

See page 63 for fixings of cross noggings and floor plate; page 99 for detail of wall movement joints.



The following are standard Architectural Specifications for timber stud partition systems using PROMATECT® 100. The designer must determine the suitability of the design to the application and requirements before undertaking or constructing any works relating to the specifications and where in doubt should obtain the advice of a suitably qualified engineer.

---

### Fire attack from either side / non loadbearing & loadbearing

---

Up to 120 minute fire resistance, integrity and insulation in accordance with the criteria of AS 1530:Part 4: 2014<sup>(1)</sup>.

---

### Acoustic performance

---

The partition system shall have a Weighted Sound Reduction Index up to  $R_w$  39.

---

### Supporting structure

---

Care should be taken that any structural element that the partition system is supported from, e.g. steel stud or perimeter steel channel, has a fire resistance equal to or greater than 120 minutes.

---

### Lining boards

---

Single layer each side 20mm thick PROMATECT® 100 PromaX® mineral boards as manufactured by Promat International (Asia Pacific) Ltd. All joints to be coincident with steel framing. Standard board dimension 1200mm x 2500mm x 20mm thick.

---

### Fixing

---

Softwood timber, 90mm deep x 45mm wide will be fixed to the perimeter of the opening where the partition system is to be installed using M12 expanding anchors at 500mm maximum centres.

Where the boards are to be installed with their long edges vertical, the studs are located at 625mm maximum centres with cross noggings at 1200mm centres. Where the boards are to be installed with their long edges horizontal, the studs are located at 625mm centres with cross noggings at 600mm centres.

The PROMATECT® 100 boards are fixed to the framework using 75mm long No.8 woodscrews at maximum 200mm centres or 75mm long nails at 200mm centres, a minimum of 12mm from the board edge.

---

### Tests & standards

---

Along with all material tests the complete system along with the framing is tested in accordance with the criteria of BS 476: Part 22: 1987 and AS 1530: Part 4: 2014<sup>(1)</sup>.

---

### Jointing

---

Plain butt joints between machined edges of boards. <sup>(2)</sup>

Joints filled in preparation for painting. <sup>(3)</sup>

Joints filled and taped in preparation for decoration. <sup>(4)</sup>

---

### Follow-on trades

---

Surface of boards to be prepared for painting/plastering/tiling<sup>(5)</sup> in accordance with manufacturer's recommendations.

#### NOTES:

- (1), (2), (3), (4), (5) delete as appropriate.
- All perimeter gaps caulked with PROMASEAL®-A Acrylic Sealant.

### Fire attack from both sides / Non loadbearing



Fire resistance	FRL	-/120/120
	Standard	BS 476: Part 22: 1987 AS 1530: Part 4: 2005
	Approval	BRANZ FAR 2837 and FAR 3309
Acoustic	# STC # R <sub>w</sub>	36dB 36dB
	Standard	ISO 140: Part 3: 1996 ISO 717: Part 1: 1996
	Predicted assessment	Marshall Day 18th October 2006
Construction	Maximum height*	4300mm
	Maximum length	Unlimited
	Partition thickness	Nominal 40mm
	Partition mass*	34kg/m <sup>2</sup>

# Margin of error is generally within ±3dB

- ① Two layers of PROMATECT® 100 board, 20mm thick each stagger the joints by at least 300mm
- ② Galvanised steel perimeter angle 50mm x 50mm x 1mm thick
- ③ 40mm long M6 masonry anchors at nominal 500mm centres
- ④ 32mm long No.8 self-tapping screws at nominal 300mm centres for first layer and 50mm long No.8 self-tapping screws at nominal 200mm centres for second layer
- ⑤ 40mm long No.10 laminating stitching screws at 200mm centres

Once 1st layer of board is screwed to the perimeter angles, all subsequent layers are:

- a) fixed to the perimeter angle, and
- b) stitched to the proceeding layers of boards

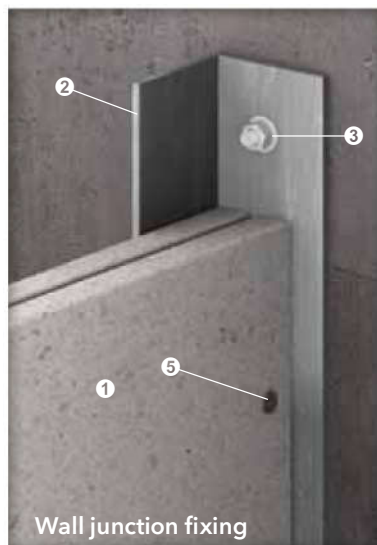
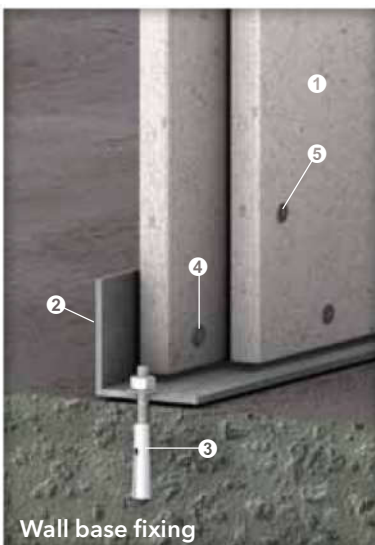

- ① PROMATECT® 100 board
- ② Galvanised steel perimeter angle 50mm x 50mm x 1mm thick
- ③ 40mm long M6 masonry anchors at nominal 500mm centres
- ④ 32mm long No.8 self-tapping screws at nominal 300mm centres for first layer and 50mm long No.8 self-tapping screws at nominal 200mm centres for second layer
- ⑤ 40mm long No.10 laminating stitching screws at 200mm centres

Once first layer of board is screwed to the perimeter angles, all subsequent layers are:

- a) fixed to the perimeter angle, and
- b) stitched to the proceeding layers of boards

### Two layer / Non loadbearing

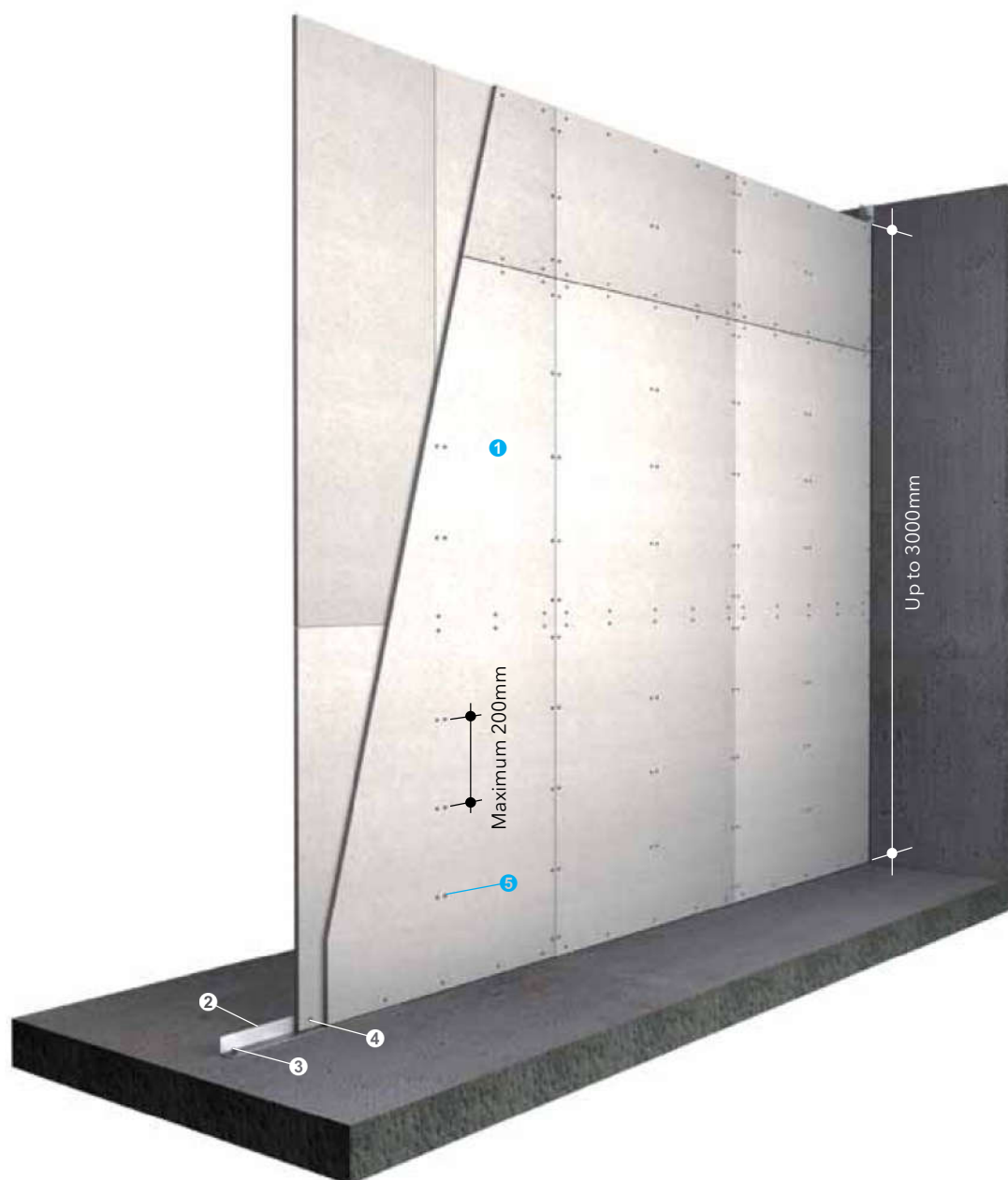

- ❶ Two layers of PROMATECT® 100 board, 20mm thick each stagger the joints by at least 300mm
- ❷ Galvanised steel perimeter angle 50mm x 50mm x 1mm thick
- ❸ 40mm long M6 masonry anchors at nominal 500mm centres
- ❹ 32mm long No.8 self-tapping screws at nominal 300mm centres for first layer and 50mm long No.8 self-tapping screws at nominal 200mm centres for second layer
- ❺ 40mm long No.10 laminating stitching screws at 200mm centres

Once first layer of board is screwed to the perimeter angles, all subsequent layers are:

- a) fixed to the perimeter angle, and
- b) stitched to the proceeding layers of boards

See page 103 for wall connection details

The following are standard Architectural Specifications for solid internal partition systems using PROMATECT® 100. The designer must determine the suitability of the design to the application and requirements before undertaking or constructing any works relating to the specifications and where in doubt should obtain the advice of a suitably qualified engineer.

---

**Fire attack from either side / non loadbearing**

---

Up to 120 minute fire resistance, integrity and insulation in accordance with the criteria of BS 476: Part 22: 1987 and AS 1530: Part 4: 2005<sup>(1)</sup>.

---

**Acoustic performance**

---

The partition system shall have a Weighted Sound Reduction Index up to  $R_w$  36.

---

**Supporting structure**

---

Care should be taken that any structural element by which the partition system is supported, e.g. steel stud or perimeter steel channel, has a fire resistance equal to or greater than 120 minutes.

---

**Lining boards**

---

Two layers of 20mm thick PROMATECT® 100 PromaX® mineral boards as manufactured by Promat International (Asia Pacific) Ltd. Stagger joints by at least 300mm. Standard board dimension 1200mm x 2500mm x 20mm thick.

---

**Fixing**

---

Galvanised steel frame made of perimeter steel angle 50mm x 50mm x 1mm thick will be fastened to the wall/floor/ceiling with 40mm long M6 masonry anchors at nominal 500mm centres.

First layer of 20mm thick PROMATECT® 100 boards will be fixed to the perimeter angle using 32mm long No.8 self-drilling or self-tapping screws at 300mm centres. Second layer 20mm, fixed to the first layer using 40mm long No.10 laminating stitching screws at 300mm centres down the centre of each panel at each board joint. Use 50mm x No.8 self-tapping screws at 200mm centres to fix second layer to the perimeter angle.

---

**Tests & standards**

---

The complete system along with material and framing is tested in accordance with the criteria of BS 476: Part 22: 1987 and AS 1530: Part 4: 2005<sup>(1)</sup>.

---

**Jointing**

---

Plain butt joints between machined edges of boards. <sup>(2)</sup>

Joints filled in preparation for painting. <sup>(3)</sup>

Joints filled and taped in preparation for decoration. <sup>(4)</sup>

---

**Follow-on trades**

---

Surface of boards to be prepared for painting/plastering/tiling<sup>(5)</sup> in accordance with manufacturer's recommendations.

**NOTES:**

- <sup>(1), (2), (3), (4), (5)</sup> delete as appropriate.
- All perimeter gaps caulked with PROMASEAL®-A Acrylic Sealant.

## Promat Australia Pty Ltd

### Head office

1 Scotland Road  
Mile End South, SA 5031  
T 1800 PROMAT (776 628)  
F +61 (8) 8352 1014  
E PAPT.Mail@etexgroup.com

### New South Wales office

Unit 1, 175 Briens Road  
Northmead, NSW 2152  
T 1800 PROMAT (776 628)  
F +61 (2) 9630 0258  
E PAPT.Mail@etexgroup.com

### Victoria office

Unit 1, 355 Grieve Pde  
Altona North, VIC 3025  
T 1800 PROMAT (776 628)  
F 1800 334 598  
E PAPT.Mail@etexgroup.com

### Queensland office

80 Stradbroke St  
Heathwood, QLD 4110  
T 1800 011 376  
F 1800 334 598  
E PAPT.Mail@etexgroup.com

- The technical data provided in this publication is based on mean values prevalent at time of publication and is thus subject to fluctuation. It should not be regarded as a guarantee to system performance.
- All data contained herein conforms to and frequently surpasses generally accepted fire protection standards recognised by most professional fire science practitioners and regulatory authorities worldwide. The same general principle is equally applicable to all Promat products and systems. Promat has access to a considerable body of test authentication data and this can be provided on a complimentary basis upon request. It should be noted however that this publication replaces all previous editions in its entirety. Any form of reproduction by any means – manual, electronic, digital or otherwise – is strictly prohibited and subject to prior approval in writing from Promat. All rights related or connected to the Promat logo, Promat registered trademarks, featured illustrations, written information and technical reports in this publication are the sole, exclusive and copyright property of Promat and its legal partner companies.

[www.promat.com](http://www.promat.com)

Your local Promat supplier

Etex is a Belgian industrial group that specialises and markets high quality building materials and systems. Founded since 1905 and headquartered in Brussels, Belgium, Etex currently operates in 123 factories and 116 subsidiaries across 44 countries, employs more than 18,000 people and is one of the largest fibre cement producers in the world.

Through its subsidiaries, the group offers an extensive range of products: small and large roofing materials, cladding and building boards, passive fire protection systems and ceramic tiles.

Etex aims to be a professional, solid partner for all kinds of building projects.

