

Promat



PASSIVE FIRE PROTECTION SYSTEMS
Application & Technical Manual:
Structural Steel Fire Protection



Structural Steel Fire Protection General Information _____	1	-	3
Calculation of Section Factor (H_p/A) _____	4	-	5
Guide of Section Factor (H_p/A) For Encasement _____	6	-	19
PROMATECT®-H Structural Steel Column Cladding _____	20	-	21
PROMATECT®-H Structural Steel Beam Cladding _____	22	-	23
PROMATECT®-H Structural Steel Column & Beam Cladding Architectural Specification _____	24	-	25
PROMATECT®-L Structural Steel Column Cladding _____	26	-	27
PROMATECT®-L Structural Steel Beam Cladding _____	28	-	29
PROMATECT®-L Structural Steel Column & Beam Cladding Architectural Specification _____	30	-	31
PROMATECT® 50 Structural Steel Column Cladding _____	32	-	34
PROMATECT® 50 Structural Steel Beam Cladding _____	35	-	36
PROMATECT® 50 Structural Steel Column & Beam Cladding Architectural Specification _____	37	-	41
PROMATECT® 100 Structural Steel Column Cladding _____	42		
PROMATECT® 100 Structural Steel Beam Cladding _____	43	-	44
PROMATECT® 100 Structural Steel Column & Beam Cladding Architectural Specification _____	45	-	46
PROMATECT® 250 Structural Steel Column Cladding _____	47		
PROMATECT® 250 Structural Steel Beam Cladding _____	48	-	49
PROMATECT® 250 Structural Steel Column & Beam Cladding Architectural Specification _____	50	-	51
PROMATECT®-H Structural Concrete/Timber Column Cladding _____	52		
CAFCO® 300 Structural Steel Column & Beam Coating _____	53	-	57
Cafco FENDOLITE® MII Structural Steel Column & Beam Coating _____	58	-	61
Cafco MANDOLITE® CP2 Structural Steel Column & Beam Coating _____	62	-	63
CAFCO® 300 / Cafco FENDOLITE® MII / Cafco MANDOLITE® CP2 Structural Steel Column & Beam Coating Architectural Specification _____	64		
Cafco SPRAYFILM® WB3 Structural Steel Column & Beam Coating _____	65	-	72
Cafco SPRAYFILM® WB3 Structural Steel Column & Beam Coating Architectural Specification _____	73		

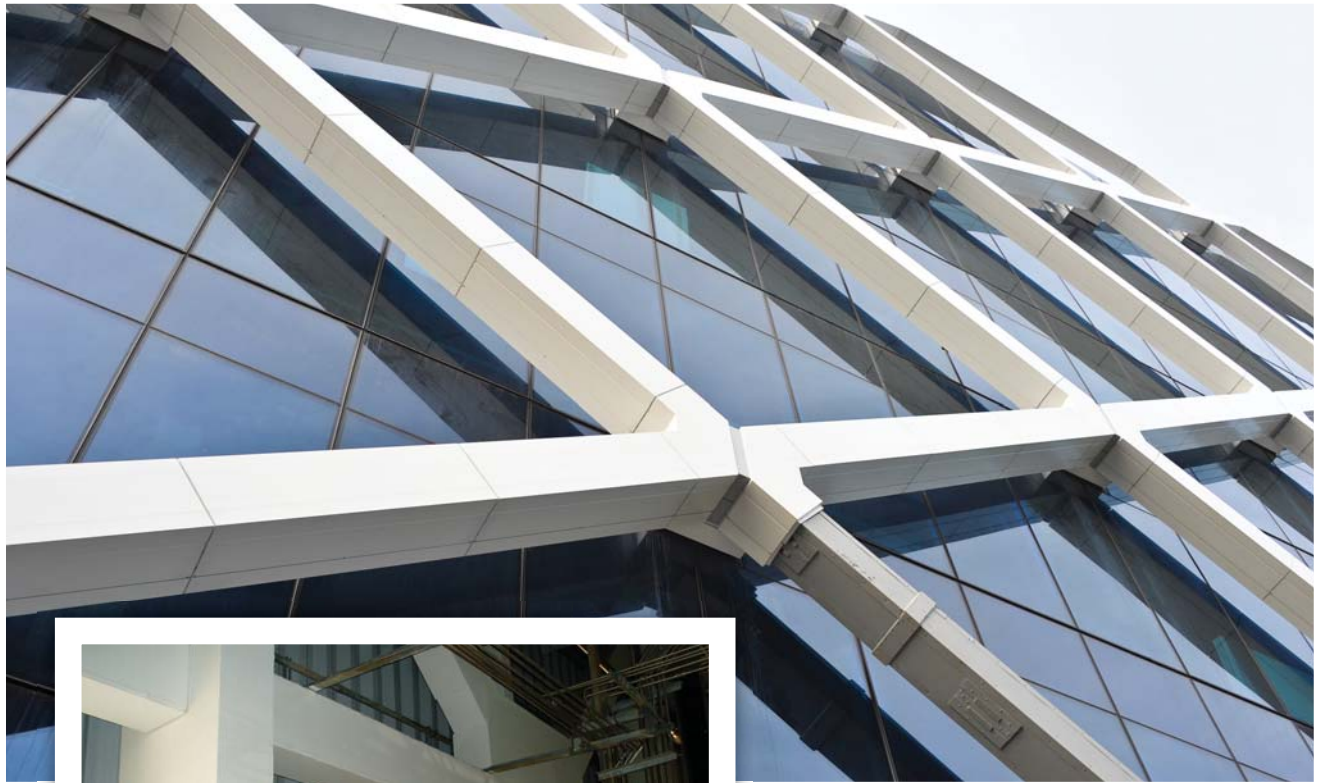

PROMATECT®-H structural steel column and beam cladding at the One Shelley Street office building (above) in Sydney, Australia and Tatan Power Point, Taiwan (left).

Numerous research programmes show that some types of fully stressed steel sections can achieve a 30 minute fire resistance without any additional protection materials being applied. However, these apply to a limited number of steel sections only, based on the allowable Section Factor H_p/A . Section Factor is a common term used in fire protection for steelwork and is discussed in detail below.

Typical building regulations usually require certain elements of structure to be fire resistant for more than 30 minutes and up to a specified minimum period of time. The thickness of any fire protection material depends on a number of factors, such as:

- Duration of fire resistance specified
- Type of protection used, e.g. board, paint, spray etc
- Perimeter of the part of steel section exposed to fire
- Shape and dimensions of the steel section

To determine how these various factors affect the fire resistance, all Promat products and systems have been tested at nationally accredited laboratories around the world to a variety of standards, e.g. BS 476: Part 21, AS 1530: Part 4, ASTM E119 and BS EN 13381.

Tests carried out in accordance with the above standards are performed on both loaded and unloaded beams and columns which are clad with fire protection material. Steel surface temperatures are monitored with thermocouples to assess the performance of the cladding. Steel that is fully stressed in accordance with the design guides BS 449 or BS 5950: Part 1 (Australian equivalent AS 4100),

begin to lose their design margin of safety at temperatures around 550°C.

The table below shows how the strength of steel reduces as temperatures rise, i.e. variation of effective yield strength factor of normal structural steels with temperature.

Temperature (°C)	20	100	200	300	400	500	600	700	800
Effective yield strength factor	1.00	1.00	1.00	1.00	1.00	0.78	0.47	0.23	0.11

For example, at 700°C, the effective yield strength of Grade 43 (S275) steel is $0.23 \times 275 = 63.25\text{N/mm}^2$.

A range of unloaded sections are also tested to obtain data for analytical calculation, to measure exactly how much protection is needed for the most common steel sections and for providing fire resistance for different time periods.

IMPORTANT: When using Promat protection systems for structural steelwork, conservative limiting temperatures of 550°C and 620°C are referred to for columns and beams respectively and are in general use throughout this brochure. Apart from temperature data, the fire tests also need to demonstrate the ability of cladding to remain in place, usually described as the “stickability” of the material, for the maximum duration for which the protection may be required. The availability of thin materials and the low weight of Promat systems, plus the possibility of prefabrication, ensure maximum cost efficiency.

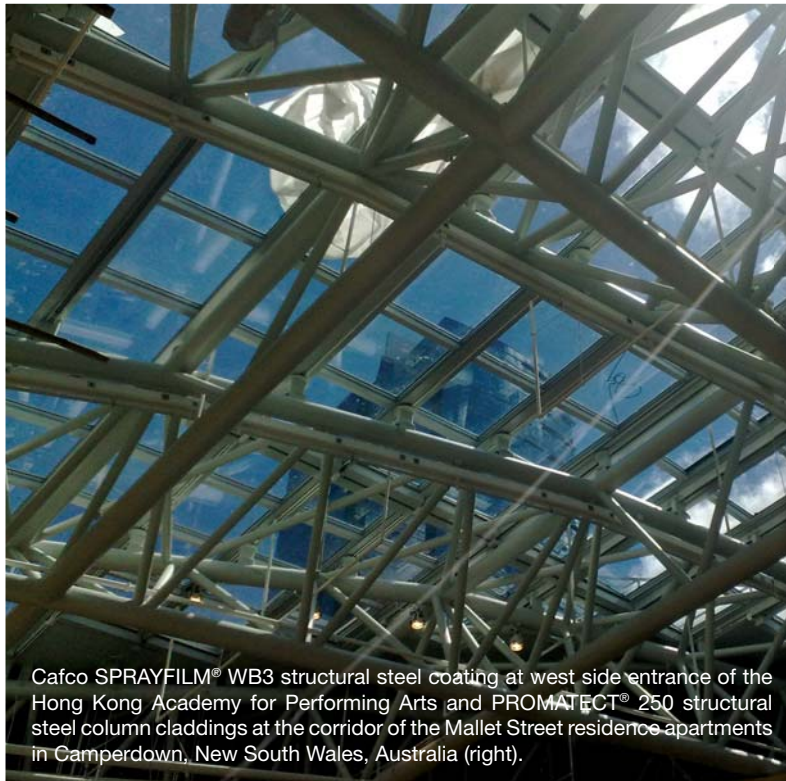

Cafco SPRAYFILM® WB3 structural steel coating at west side entrance of the Hong Kong Academy for Performing Arts and PROMATECT® 250 structural steel column claddings at the corridor of the Mallet Street residence apartments in Camperdown, New South Wales, Australia (right).



Section Factor (Hp/A)

The degree of fire protection provided depends on the Hp/A Section Factor for the steel section. The Hp/A factor is a function of the area of the steel exposed to the fire and the mass of the steel section. The higher the Hp/A, the faster the steel section heats up and so the greater the thickness of fire protection material required.

It should be noted that in European design standards, the section factor is presented as A/V which has the same numerical value as Hp/A. A/V measures the rate of temperature increase of a steel cross section by the ratio of the heated surface area to the volume. It is likely to gradually replace the use of Hp/A.

Depending on type of material used for protection, the calculation method for Hp/A value may differ. Generally there are two methods of construction for the protection materials: box protection and profile protection.

Box Protection Using Board Materials

For box protection, Hp is the sum of the inside dimensions of the smallest possible rectangular or square encasement of the steel section. One exception is circular hollow sections. See page 4.

Where a steel section abuts or is built into a fire resisting wall or floor, the surface in contact with or the surface within the wall or floor is ignored when calculating Hp.

However, the value A is always the total cross sectional area of the whole steel section.

Profile Protection Using Spray/Paint Materials

Encasements following the profile of the steel section will generally have a higher Hp/A section factor than a box encasement. One exception is circular hollow sections. See page 5.

The serial size and mass per metre of most steel sections are available in tables from steel manufacturers. Sometimes such tables also provide Hp/A values calculated for three or four sided box protection.

Following is an example of a calculation for a steel beam section of 406mm x 178mm x 54kg/m serial size to be encased on 3 sides using box protection method:

Serial size	= 406mm x 178mm
Actual size	= 402.6mm x 177.6mm
Hp	= B + 2D = 177.6 + 2 x 402.6 = 982.8mm (0.9828m)
A	= 68.4cm ² (0.00684m ²)
Hp/A	= 0.9828 ÷ 0.00684 = 144.7m ⁻¹ ≈ 144m ⁻¹

The value of A, the cross sectional area, can be obtained either from steelwork tables or by accurate measurement. However, if the mass per metre is known then the Hp/A value can be calculated as follows:

$\frac{Hp}{A}$	= $\frac{7850 \times Hp}{W}$
Where W	= Mass of per metre (kg/m)
Where 7850	= Nominal density of steel

Sample calculation using the previous example:

$\frac{Hp}{A}$	= $\frac{7850 \times 0.9828}{54}$
	= 142.87m ⁻¹
	≈ 143m ⁻¹

The shape of the steel section can also play an important role when determining the required thickness of a protection material. Following are some notes for reference. For details on steel profiles not outlined here, please consult Promat.

Castellated Sections / Cellform Beams

These steel members heat up more quickly than the original section from which they were produced. Common practice is that protection thickness should therefore be 20% greater than those calculated from the H_p/A value of the original section from which the castellated section is formed.

However, it should be noted that the above information is now superseded by a new, more scientific approach for the protection of castellated sections. The following is taken from "Fire Protection for Structural Steel in Buildings", 4th Edition, published by the ASFP (see www.asfp.org.uk).

The recently amended method of obtaining the section factor (H_p/A) for castellated sections is now specific. In fact, the recommendation from the Steel Construction Institute, published as RT 1085, for castellated sections and cellular beams manufactured from all rolled steel sections and from welded plate, the Section Factor for passive protection system is calculated as:

$$\text{Section factor (m}^{-1}\text{)} = 1400/t$$

Where t = the thickness (mm) of the lower steel web and applies for beams made from all steel rolled sections and from welded steel plate.

It should be noted that there are a number of conditions attached to the use of this calculation method, which are detailed in the ASFP "Yellow Book" publication.

Individual protection products, normally quite similar in performance when compared on the basis of rolled steel sections, may require radically different thicknesses for the same cellular beam.

Structural Hollow Section

The same thickness of board materials can be used on square, rectangular and circular hollow sections as on 'I' sections of the same H_p/A value.

Bracing

Bracing is included in a structure to give resistance to wind forces and provide overall stiffness. Masonry walls and steel cladding contribute to a structure's rigidity but these are rarely taken into account in design. Also, the probability of a major fire occurrence concurrent with maximum wind load is remote (see BS 5950: Part 8). It seems unreasonable therefore to apply the 550°C steel temperature criteria to bracing. While each case must be judged on individual merits, protection to bracing is generally not necessary, but where it is required the H_p/A value of the bracing section or 200m^{-1} should be used, whichever is the lesser.

Lattice Members

As the determination of the protection necessary to protect lattice members requires broad consideration of the lattice design, please consult Promat concerning such steel sections.

Partially Exposed Members

Where columns or beams are partly built into or are in close contact with walls or floors, the protection afforded to the steelwork by the wall or floor should be taken into account. In those instances where the steel section sits within or against masonry or concrete constructions, this will give protection to the adjacent surface of the steelwork. Thus, for the purpose of determining the heated perimeter (H_p), this should be taken as only that part of the steel section which is exposed. It should be noted that where the steelwork penetrates both sides of a fire resisting construction, e.g. a wall protruding into a space which has an open end, simultaneous attack from fire on both sides may occur on columns partially exposed within the wall. In such an instance, the section factor should be calculated based upon the sum of the areas exposed to fire on either side of the wall and the total volume of the steel section.

Note that separating elements are generally required to offer a performance including the insulation criteria of 140°C or 180°C. Therefore, where a steel section passes through a separating element and is exposed on both sides, consideration must also be given to providing sufficient protection not only to maintain the temperature of the steel section below 550°C but also to ensure the surface temperature on the unexposed face does not exceed the 140°C or 180°C insulation criteria of the separating element. Due allowance for any expected building movement should also be considered.

External Lightweight Walls

Where the structural elements form portal legs supporting a lightweight external wall, the insulation performance required of the wall may contribute to the protection of any column flange falling within the thickness of the wall. In such cases, please consult Promat to confirm the board thickness and which areas of such columns should be protected.

Internal Lightweight Partitions/Walls

Where a column or beam is built into a fire resistant lightweight wall or partition, the protection to the steelwork can generally be designed on the assumption that only one side of the wall or partition will be exposed to fire at any one time. The wall or partition should be adequately secured to the column in such a way as to ensure the wall or partition will not apply stress on the protection encasement. Due allowance for any expected building movement should be considered.

Floors

Where beams are wholly within the cavity of a timber floor protected by a PROMATECT®-H ceiling, test evidence shows that the cavity air temperature of the floor is such that the beam will be adequately protected to the same fire resistance by the ceiling that protects the floor. Where the beam is wholly or partly below the line of the PROMATECT®-H ceiling then H_p should be based upon the portion of the steel beam that is below ceiling level.

Beams Supporting Composite Floors With Profiled Metal Decking

A series of fire resistance tests has demonstrated that it is not always necessary to fill the void formed between the top flange of a beam and the underside of a profiled steel deck. Recommendations based on the research have been published by the Steel Construction Institute (UK) and for decks running perpendicular to the beams, are as follows:

DOVETAIL DECKS

Voids may be left unfilled for all fire resistance period, unless a fire resisting wall or partition is located beneath the beam.











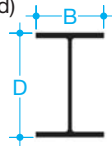

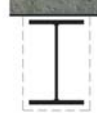
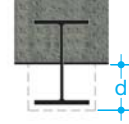

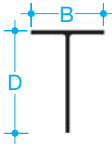



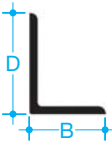

TRAPEZOIDAL DECKS

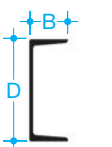
Generally, voids may be left unfilled for up to 60 minutes fire resistance. Also, for 90 minutes if the board thickness used is appropriate for the $H_p/A + 15\%$. Care should be taken to ensure that if the voids are unfilled, the main encasement will need to be adequately secured. For periods over 90 minutes the voids should be filled.

In all instances, voids should also be filled if a fire wall is located beneath the beam, for all fire resistance periods. These recommendations apply to board encasements. The trapezoidal steel deck slab should be designed to act structurally with the beam. If this is not the case, the voids should be filled for all fire resistance periods.

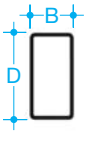
Various Box Protection

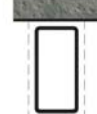
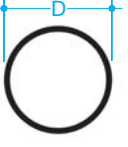
Protection configurations with values of perimeter Hp for use in the calculation of section factor Hp/A (A/V)

Steel section	Box protection				
Universal beams, universal columns and joists (plain and castellated) 	Four sides  $2B + 2D$	Three sides  $B + 2D$	Three sides (partially exposed)  $B + 2d$	Two sides  $B + D$	One side (partially exposed)  B
Structural and rolled tees 	Four sides  $2B + 2D$	Three sides (flange to soffit)  $B + 2D$	Three sides (toe of web to soffit)  $B + 2D$		
Angles 	Four sides  $2B + 2D$	Three sides (flange to soffit)  $B + 2D$	Three sides (toe of flange soffit)  $B + 2D$		
Channels 	Four sides  $2B + 2D$	Three sides (web to soffit)  $2B + D$	Three sides (flange to soffit)  $B + 2D$		
Square or rectangular hollow sections 	Four sides  $2B + 2D$	Three sides  $B + 2D$			
Circular hollow sections 	Four sides  πD	NOTE: The air space created in boxing a circular section improves the insulation and the value of Hp/A. Therefore, Hp higher than profile protection (p) would be anomalous. Hence, Hp is taken as the circumference of the circular section and not 4D.			

Following is an example of calculation for a universal beam section using box protection of 305mm x 305mm x 240kg/m serial size to be encased on three or four sides when $A = 305.6\text{cm}^2$, $B = 317.9\text{mm}$, $D = 352.6\text{mm}$, $t = 23\text{mm}$.

Four sided box protection:

$$\begin{aligned}
 H_p &= 2B + 2D \\
 &= (2 \times 317.9) + (2 \times 352.6) \\
 &= 1341\text{mm} (1.341\text{m}) \\
 H_p/A &= 1.341 \div 0.03056 \\
 &= 43.9\text{m}^{-1}
 \end{aligned}$$











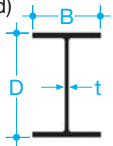

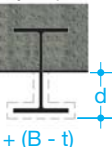

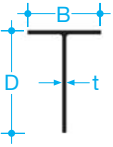

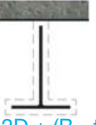

Three sided box protection:

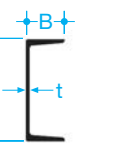
$$\begin{aligned}
 H_p &= B + 2D \\
 &= 317.9 + (2 \times 352.6) \\
 &= 1023.1\text{mm} (1.023\text{m}) \\
 H_p/A &= 1.023 \div 0.03056 \\
 &= 33.5\text{m}^{-1}
 \end{aligned}$$

The above calculated values are approximate in that radii at corners and roots of all sections are ignored. In these figures, $H_p/A = A/V$.

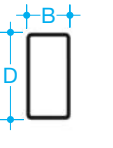
Various Profile Protection

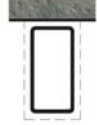
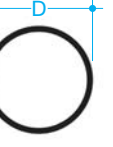
Protection configurations with values of perimeter Hp for use in the calculation of section factor Hp/A (A/V)

Steel section	Profile protection				
Universal beams, universal columns and joists (plain and castellated)  Hp	Four sides  $2B + 2D + 2(B - t) = 4B + 2D - 2t$	Three sides  $B + 2D + 2(B - t) = 3B + 2D - 2t$	Three sides (partially exposed)  $B + 2d + (B - t) = 2B + 2d - t$	Two sides  $B + D + 2(B - t)/2 = 2B + D - t$	One side (partially exposed)  B
Structural and rolled tees  Hp	Four sides  $2B + 2D$	Three sides (flange to soffit)  $B + 2D$	Three sides (toe of web to soffit)  $B + 2D + (B - t) = 2B + 2D - t$		
Angles  Hp	Four sides  $2B + 2D$	Three sides (flange to soffit)  $B + 2D$	Three sides (toe of flange soffit)  $B + 2D + (B - t) = 2B + 2D - t$		
Channels  Hp	Four sides  $2B + 2D + 2(B - t) = 4B + 2D - 2t$	Three sides (web to soffit)  $2B + D + 2(B - t) = 4B + D - 2t$	Three sides (flange to soffit)  $B + 2D + 2(B - t) = 3B + 2D - 2t$		
Square or rectangular hollow sections  Hp	Four sides  $2B + 2D$	Three sides  $B + 2D$			
Circular hollow sections  Hp	Four sides  πD				

Following is an example of calculation for a universal beam section using profile protection of 305mm x 305mm x 240kg/m serial size to be encased on three or four sides when $A = 305.6\text{cm}^2$, $B = 317.9\text{mm}$, $D = 352.6\text{mm}$, $t = 23\text{mm}$.

Four sided profile protection: $H_p = 4B + 2D - 2t$ $= (4 \times 317.9) + (2 \times 352.6) - (2 \times 23)$ $= 1930.8\text{mm} (1.931\text{m})$ $H_p/A = 1.931 \div 0.03056$ $= 63.1\text{m}^{-1}$	Three sided profile protection: $H_p = 3B + 2D - 2t$ $= (3 \times 317.9) + (2 \times 352.6) - (2 \times 23)$ $= 1612.9\text{mm} (1.613\text{m})$ $H_p/A = 1.613 \div 0.03056$ $= 52.8\text{m}^{-1}$
--	---

The above calculated values are approximate in that radii at corners and roots of all sections are ignored. In these figures, $H_p/A = A/V$.

Universal Columns

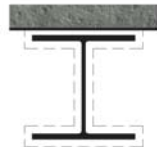
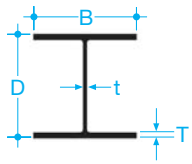

Three sides

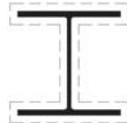

Four sides

Profile protection

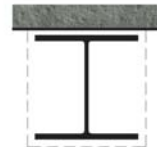

Three sides

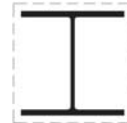

Four sides

Box protection

Designation		Depth of section D (mm)	Width of section B (mm)	Thickness		Area of section (cm ²)	Profile protection		Box protection	
Serial size (mm)	Mass (kg/m)			Web t (mm)	Flange T (mm)		Three sides (m ⁻¹)	Four sides (m ⁻¹)	Three sides (m ⁻¹)	Four sides (m ⁻¹)
356 x 406	634	474.7	424.1	47.6	77.0	808.1	25	30	15	20
	551	455.7	418.5	42.0	67.5	701.8	30	35	20	25
	467	436.6	412.4	35.9	58.0	595.5	35	40	20	30
	393	419.1	407.0	30.6	49.2	500.9	40	45	25	35
	340	406.4	403.0	26.5	42.9	432.7	45	55	30	35
	287	363.7	399.0	22.6	36.5	366.0	50	65	30	45
	235	381.0	395.0	18.5	30.2	299.8	65	75	40	50
356 x 368	202	374.7	374.4	16.8	27.0	257.9	70	85	45	60
	177	368.3	372.1	14.5	23.8	255.7	80	95	50	65
	153	362.0	370.2	12.6	20.7	195.2	90	110	55	75
	129	355.6	368.3	10.7	17.5	164.9	105	130	65	90
305 x 305	283	365.3	321.8	26.9	44.1	360.4	45	55	30	40
	240	352.6	317.9	23.0	37.7	305.6	50	60	35	45
	198	339.9	314.1	19.2	31.4	252.3	60	75	40	50
	158	327.6	310.6	15.7	25.0	201.2	75	90	50	65
	137	320.5	308.7	13.8	21.7	174.6	85	105	55	70
	118	314.5	306.8	11.9	18.7	149.8	100	120	60	85
	97	307.8	304.8	9.9	15.4	123.3	120	145	75	100
254 x 254	167	289.1	264.5	19.2	31.7	212.4	60	75	40	50
	132	276.4	261.0	15.6	25.3	167.7	75	90	50	65
	107	266.7	258.3	13.0	20.5	136.6	90	110	60	75
	89	260.4	255.9	10.5	17.3	114.0	110	130	70	90
	73	254.0	254.0	8.6	14.2	92.9	130	160	80	110
203 x 203	127	241.4	213.9	18.1	30.1	162.0	65	80	45	55
	113	235.0	212.1	16.3	26.9	145.0	75	90	45	60
	100	228.6	210.3	14.5	23.7	127.0	80	100	55	70
	86	222.3	208.8	13.0	20.5	110.1	95	115	60	80
	71	215.9	206.2	10.3	17.3	91.1	110	135	70	95
	60	209.6	205.2	9.3	14.2	75.8	130	160	80	110
	52	206.2	203.9	8.0	12.5	66.4	150	180	95	125
	46	203.2	203.2	7.3	11.0	58.8	170	200	105	140
152 x 152	51	170.2	157.4	11.0	15.7	65.2	120	145	75	100
	44	166.0	155.9	9.5	13.6	56.1	132	165	85	115
	37	161.8	154.4	8.1	11.5	47.4	160	195	100	135
	30	157.5	152.9	6.6	9.4	38.2	195	235	120	160
	23	152.4	152.4	6.1	6.8	29.8	245	305	155	205

Universal Beams

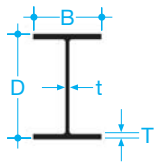

Three sides



Four sides

Profile protection



Three sides



Four sides

Box protection

Designation		Depth of section D (mm)	Width of section B (mm)	Thickness		Area of section (cm ²)	Profile protection		Box protection	
Serial size (mm)	Mass (kg/m)			Web t (mm)	Flange T (mm)		Three sides (m ⁻¹)	Four sides (m ⁻¹)	Three sides (m ⁻¹)	Four sides (m ⁻¹)
1016 x 305	487	1036.1	308.5	30.0	54.1	619.9	45	50	40	45
	438	1025.9	305.4	26.9	49.0	556.6	50	55	40	50
	393	1016.0	303.0	24.4	43.9	500.2	55	65	45	55
	349	1008.1	302.0	21.1	40.0	445.2	65	70	50	60
	314	1000.0	300.0	19.1	35.9	400.4	70	80	55	65
	272	990.1	300.0	16.5	31.0	346.9	80	90	65	75
	249	980.2	300.0	16.5	26.0	316.9	90	95	70	80
	222	970.3	300.0	16.0	21.1	282.8	95	110	80	90
914 x 419	388	920.5	420.5	21.5	36.6	494.5	60	70	45	55
	343	911.4	418.5	19.4	32.0	437.5	70	80	50	60
914 x 305	289	926.6	307.8	19.6	32.0	368.8	75	80	60	65
	253	918.5	305.5	17.3	27.9	322.8	85	95	65	75
	224	910.3	304.1	15.9	23.9	285.3	95	105	75	85
838 x 292	201	903.0	303.4	15.2	20.2	256.4	105	115	80	95
	226	850.9	293.8	16.1	26.8	288.7	85	95	70	80
	194	840.7	292.4	14.7	21.7	247.2	100	115	80	90
762 x 267	176	834.9	291.6	14.0	18.8	224.1	110	125	90	100
	197	769.6	268.0	15.6	25.4	250.8	90	100	70	85
	173	762.0	266.7	14.3	21.6	220.5	105	115	80	95
686 x 254	147	753.9	265.3	12.9	17.5	188.1	120	135	95	110
	134	750.0	264.4	12.0	15.5	170.6	130	145	105	120
	170	692.9	255.8	14.5	23.7	216.6	95	110	75	90
610 x 305	152	687.6	254.5	13.2	21.0	193.8	105	120	85	95
	140	683.5	253.7	12.4	19.0	178.6	115	130	90	105
	125	677.9	253.0	11.7	16.2	159.6	130	145	100	115
610 x 229	238	633.0	311.5	18.6	31.4	303.8	70	80	50	60
	179	617.5	307.0	14.1	23.6	227.9	90	105	70	80
	149	609.6	304.8	11.9	19.7	190.1	110	125	80	95
610 x 178	140	617.0	230.1	13.1	22.1	178.4	105	120	80	95
	125	611.9	229.0	11.9	19.6	159.6	115	130	90	105
	113	607.3	228.2	11.2	17.3	144.5	130	145	100	115
533 x 312	101	602.2	227.6	10.6	14.8	129.2	140	160	110	130
	100	607.4	179.2	11.3	17.2	128.0	135	150	110	125
	92	603.0	178.8	10.9	15.0	117.0	145	160	120	135
533 x 210	82	598.6	177.9	10.0	12.8	104.0	160	180	130	150
	273	577.1	320.2	21.1	37.6	348.0	60	70	40	50
	219	560.3	317.4	18.3	29.2	279.0	70	85	50	65
533 x 165	182	550.7	314.5	15.2	24.4	231.0	85	100	60	75
	151	542.5	312.0	12.7	20.3	192.0	105	120	75	90
	138	549.1	213.9	14.7	23.6	176.0	95	110	75	85
533 x 165	122	544.6	211.9	12.8	21.3	155.8	110	120	85	95
	109	539.5	210.7	11.6	18.8	138.6	120	135	95	110
	101	536.7	210.1	10.9	17.4	129.3	130	145	100	115
	92	533.1	209.3	10.2	15.6	117.8	140	160	110	125
	82	528.3	208.7	9.6	13.2	104.4	155	175	120	140
533 x 165	85	534.9	166.5	10.3	16.5	108.0	140	155	115	130
	75	529.1	165.9	9.7	13.6	95.2	160	175	130	145
	66	524.7	165.1	8.9	11.4	83.7	180	200	145	165

Continued on next page

Universal Beams

Continued from previous page

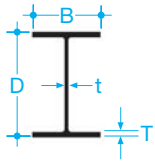

Three sides

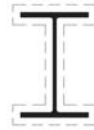

Four sides

Profile protection



Three sides



Four sides

Box protection

Designation		Depth of section D (mm)	Width of section B (mm)	Thickness		Area of section (cm ²)	Profile protection		Box protection	
Serial size (mm)	Mass (kg/m)			Web t (mm)	Flange T (mm)		Three sides (m ²)	Four sides (m ²)	Three sides (m ²)	Four sides (m ²)
457 x 191	161	492.0	199.4	18.0	32.0	206.0	75	85	60	65
	133	480.6	196.7	15.3	26.3	170.0	90	100	70	80
	106	469.2	194.0	12.6	20.6	135.0	110	125	85	100
	98	467.4	192.8	11.4	19.6	125.3	120	135	90	105
	89	463.6	192.0	10.6	17.7	113.9	130	145	100	115
	82	460.2	191.3	9.9	16.0	104.5	140	160	105	125
	74	457.2	190.5	9.1	14.5	95.0	150	175	115	135
	67	453.6	189.9	8.5	12.7	85.4	170	190	130	150
475 x 152	82	465.1	153.5	10.7	18.9	104.5	130	145	105	120
	74	461.3	152.7	9.9	17.0	95.0	140	155	115	130
	67	457.2	151.9	9.1	15.0	85.4	155	175	125	145
	60	454.7	152.9	8.0	13.3	75.9	175	195	140	160
	52	449.8	152.4	7.6	10.9	66.5	200	220	160	180
406 x 178	85	417.2	181.9	10.9	18.2	109.0	125	140	95	110
	74	412.8	179.7	9.7	16.0	95.0	140	160	105	125
	67	409.4	178.8	8.8	14.3	85.5	155	175	115	140
	60	406.4	177.8	7.8	12.8	76.0	175	195	130	155
	54	402.6	177.6	7.6	10.9	68.4	190	215	145	170
406 x 140	53	406.6	143.3	7.9	12.9	67.9	180	200	140	160
	46	402.3	142.4	6.9	11.2	59.0	205	230	160	185
	39	397.3	141.8	6.3	8.6	49.4	240	270	190	220
356 x 171	67	364.0	173.2	9.1	15.7	85.4	140	160	105	125
	57	358.6	172.1	8.0	13.0	72.2	165	190	125	145
	51	355.6	171.5	7.3	11.5	64.6	185	210	135	165
	45	352.0	171.0	6.9	9.7	57.0	210	240	155	185
356 x 127	39	352.8	126.0	6.5	10.7	49.4	215	240	170	195
	33	348.5	125.4	5.9	8.5	41.8	250	280	195	225
305 x 165	54	310.9	166.8	7.7	13.7	68.4	160	185	115	140
	46	307.1	165.7	6.7	11.8	58.9	185	210	130	160
	40	303.8	165.1	6.1	10.2	51.5	210	240	150	180
305 x 127	48	310.4	125.2	8.9	14.0	60.8	160	180	125	145
	42	306.6	124.3	8.0	12.1	53.2	180	200	140	160
	37	303.8	123.5	7.2	10.7	47.5	200	225	155	180
305 x 102	33	312.7	102.4	6.6	10.8	41.8	215	240	175	200
	28	308.9	101.9	6.1	8.9	36.3	245	275	200	225
	25	304.8	101.6	5.8	6.8	31.4	285	315	255	260
254 x 146	43	259.6	147.3	7.3	12.7	55.1	170	195	120	150
	37	256.0	146.4	6.4	10.9	47.5	195	225	140	170
	31	251.5	146.1	6.1	8.6	40.0	230	265	160	200
254 x 102	28	260.4	102.1	6.4	10.0	36.2	220	250	170	200
	25	257.0	101.9	6.1	8.4	32.2	245	280	190	220
	22	254.0	101.6	5.8	6.8	28.4	275	315	215	250
203 x 133	30	206.8	133.8	6.3	9.6	38.0	210	245	143	180
	25	203.2	133.4	5.8	7.8	32.3	240	285	165	210
203 x 102	23	203.2	101.8	5.4	9.3	29.4	235	270	175	205
178 x 102	19	177.8	101.2	4.8	7.9	24.3	260	305	190	230
152 x 89	16	152.4	88.7	4.5	7.7	20.3	270	315	195	235
127 x 76	13	127.0	76.0	4.0	7.6	16.5	280	326	200	245

Joists

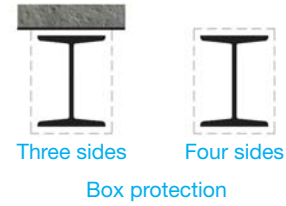
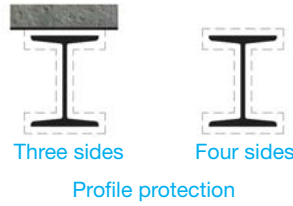
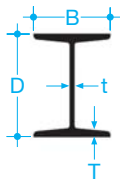

Designation		Depth of section D (mm)	Width of section B (mm)	Thickness		Area of section (cm ²)	Profile protection		Box protection	
Serial size (mm)	Mass (kg/m)			Web t (mm)	Flange T (mm)		Three sides (m ⁻¹)	Four sides (m ⁻¹)	Three sides (m ⁻¹)	Four sides (m ⁻¹)
254 x 203	81.9	254.0	203.2	10.2	19.9	104.4	95	115	70	90
254 x 114	37.2	254.0	114.3	7.6	12.8	47.4	165	190	130	155
203 x 152	52.1	203.2	152.4	8.9	16.5	66.4	115	140	85	105
203 x 102	25.3	203.2	101.6	5.8	10.4	32.3	205	235	155	190
178 x 102	21.5	177.8	101.6	5.3	9.0	27.4	225	260	165	205
152 x 127	37.2	152.4	127.0	10.4	13.2	47.5	130	155	90	120
152 x 89	17.1	152.4	88.9	4.9	8.3	21.8	245	285	180	220
152 x 768	17.9	152.4	76.2	5.8	9.6	22.8	215	245	165	200
127 x 114	29.8	127.0	114.3	10.2	11.5	37.3	140	175	100	130
127 x 114	26.8	127.0	114.3	7.4	11.4	34.1	155	190	110	140
127 x 76	16.4	127.0	76.2	5.6	9.6	21.0	205	245	155	195
127 x 76	13.4	127.0	76.2	4.5	7.6	17.0	265	310	195	240
114 x 114	26.8	114.3	114.3	9.5	10.7	34.4	145	180	100	135
102 x 102	23.1	101.6	101.6	9.5	10.3	29.4	150	185	105	140
102 x 64	9.7	101.6	63.5	4.1	6.6	12.3	295	345	215	270
102 x 44	7.4	101.6	44.4	4.3	6.1	9.5	320	365	260	305
89 x 89	19.4	88.9	88.6	9.5	9.9	24.9	155	190	105	145
76 x 76	14.7	76.2	80.0	8.9	8.4	19.1	175	220	120	165
76 x 76	12.7	76.2	76.2	5.1	8.4	16.3	205	250	140	185

Channels

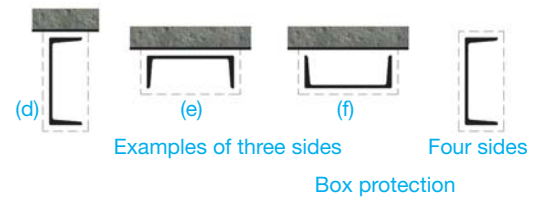
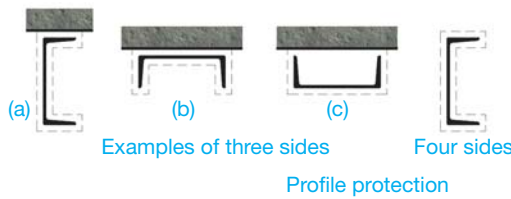
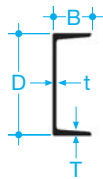

Designation		Depth of section D (mm)	Width of section B (mm)	Thickness		Area of section (cm ²)	Profile protection				Box protection			
Serial size (mm)	Mass (kg/m)			Web t (mm)	Flange T (mm)		(a) Three sides (m ⁻¹)	(b) Three sides (m ⁻¹)	(c) Three sides (m ⁻¹)	Four sides (m ⁻¹)	(d) Three sides (m ⁻¹)	(e) Three sides (m ⁻¹)	(f) Three sides (m ⁻¹)	Four sides (m ⁻¹)
430 x 100	64.4	430	100	11.0	19.0	82.1	135	95	75	150	115	75	75	130
380 x 100	54.0	380	100	9.5	17.5	68.7	150	110	85	165	125	85	85	140
300 x 100	45.5	300	100	9.0	16.5	58.0	150	115	85	165	120	85	85	140
300 x 90	41.4	300	90	9.0	15.5	52.8	160	120	90	175	130	90	90	150
260 x 90	34.8	260	90	8.0	14.0	44.4	170	135	100	190	135	100	100	160
260 x 75	27.6	260	75	7.0	12.0	35.1	205	150	115	225	170	115	115	190
230 x 90	32.2	230	90	7.5	14.0	41.0	170	140	100	195	135	100	100	155
230 x 75	25.7	230	75	6.5	12.5	32.7	200	155	115	225	165	115	115	185
200 x 90	29.7	200	90	7.0	14.0	37.9	170	140	100	195	130	100	100	155
200 x 75	23.4	200	75	6.0	12.5	29.9	200	160	115	225	160	115	115	185
180 x 90	26.1	180	90	6.5	12.5	33.2	185	155	110	210	135	110	110	165
180 x 75	20.3	180	75	6.0	10.5	25.9	215	175	125	245	170	125	125	195
150 x 90	23.9	150	90	6.5	12.0	30.4	180	160	110	210	130	110	110	160
150 x 75	17.9	150	75	5.5	10.0	22.8	220	190	130	255	165	130	130	200
125 x 65	14.8	125	65	5.5	9.5	18.8	225	195	135	260	170	135	135	200
100 x 50	10.2	100	50	5.0	8.5	13.0	225	215	155	295	190	155	155	230

Equal Angles

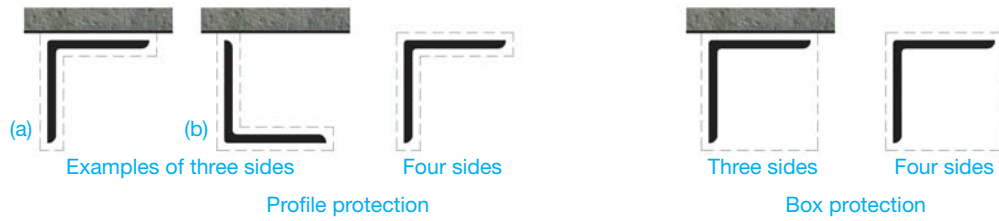
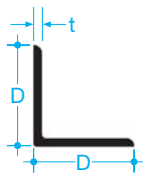

Designation		Thickness t (mm)	Area of section (cm ²)	Profile protection			Box protection	
Size D x D (mm)	Mass (kg/m)			(a) Three sides (m ²)	(b) Three sides (m ²)	Four sides (m ²)	Three sides (m ²)	Four sides (m ²)
200 x 200	71.1	24	90.6	65	85	85	65	90
	59.9	20	76.3	75	100	105	80	105
	54.2	18	69.1	85	110	115	85	115
	48.5	16	61.8	95	125	125	95	130
150 x 150	40.1	18	51.0	85	110	115	90	115
	33.8	15	43.0	100	135	135	105	140
	27.3	12	34.8	125	165	170	130	170
	23.0	10	29.3	150	200	200	155	205
120 x 120	26.6	15	33.9	105	135	140	105	140
	21.6	12	27.5	125	170	170	130	175
	18.2	10	23.2	150	200	200	155	205
	14.7	8	18.7	185	250	250	190	255
100 x 100	21.9	15	27.9	105	135	140	105	145
	17.8	12	22.7	130	170	170	130	175
	15.0	10	19.2	150	200	205	155	210
	12.2	8	15.5	185	250	250	195	260
90 x 90	15.9	12	20.3	130	170	175	135	175
	13.4	10	17.1	150	200	205	155	210
	10.9	8	13.9	190	245	250	195	260
	9.6	7	12.2	215	280	285	220	295
80 x 80	11.9	10	15.1	155	205	205	160	210
	9.6	8	12.3	190	250	255	195	260
	7.3	6	9.4	250	330	335	255	340
70 x 70	10.3	10	13.1	155	205	210	160	215
	8.4	8	10.6	190	250	255	195	260
	6.4	6	8.1	250	330	335	255	340
60 x 60	8.7	10	11.1	155	205	210	160	215
	7.1	8	9.0	190	250	260	200	265
	5.4	6	6.9	250	330	335	260	345
	4.6	5	5.8	300	395	400	305	410
50 x 50	5.8	8	7.4	195	255	260	200	270
	4.5	6	5.7	255	335	340	260	350
	3.8	5	4.8	300	400	405	310	415
45 x 45	4.0	6	5.1	255	335	340	265	350
	3.4	5	4.3	300	400	405	310	415
	2.7	4	3.5	370	490	495	385	510
40 x 40	3.5	6	4.5	255	340	345	265	355
	3.0	5	3.8	305	400	410	315	420
	2.4	4	3.1	375	495	500	390	515
25 x 25	1.8	5	2.3	315	415	430	335	445
	1.5	4	1.9	390	515	525	405	545
	1.1	3	1.4	505	680	685	530	710

Unequal Angles

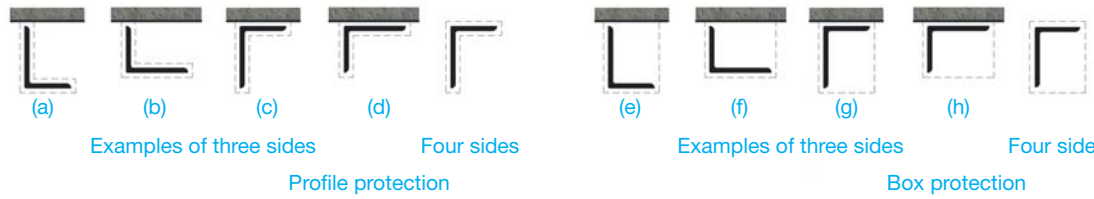
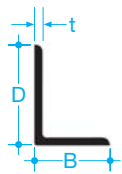

Designation		Thickness t (mm)	Area of section (cm ²)	Profile protection					Box protection				
Size D x B (mm)	Mass (kg/m)			(a) Three sides (m ²)	(b) Three sides (m ²)	(c) Three sides (m ²)	(d) Three sides (m ²)	Four sides (m ²)	(e) Three sides (m ²)	(f) Three sides (m ²)	(g) Three sides (m ²)	(h) Three sides (m ²)	Four sides (m ²)
200 x 150	47.1	18	60.0	110	110	90	80	115	90	85	90	85	115
	39.6	15	50.5	135	135	105	95	135	110	100	110	100	140
	32.0	12	40.8	165	165	130	120	170	135	120	135	120	170
200 x 100	33.7	15	43.0	135	135	115	90	135	115	95	115	95	140
	27.3	12	34.8	165	165	140	110	170	145	115	145	115	170
	23.0	10	29.2	195	195	165	135	200	170	135	170	135	205
150 x 90	26.6	15	33.9	135	135	110	95	140	115	95	115	95	140
	21.6	12	27.5	165	165	140	115	170	140	120	140	120	175
	18.2	10	23.2	200	200	165	140	205	170	140	170	140	205
150 x 75	24.8	15	31.6	135	135	115	90	140	120	95	120	95	140
	20.2	12	25.7	165	165	140	115	170	145	115	145	115	175
	17.0	10	21.6	200	200	170	135	205	175	140	175	140	210
125 x 75	17.8	12	22.7	165	165	140	115	170	145	120	145	120	175
	15.0	10	19.1	200	200	165	140	205	170	145	170	145	210
	12.2	8	15.5	245	245	205	170	250	210	175	210	175	260
100 x 75	15.4	12	19.7	170	170	135	125	175	140	125	140	125	180
	13.0	10	16.6	200	200	160	145	205	165	150	165	150	210
	10.6	8	13.5	250	250	200	180	255	205	185	205	185	260
100 x 65	12.3	10	15.6	200	200	165	140	205	170	145	170	145	210
	9.9	8	12.7	245	245	200	175	255	210	180	210	180	260
	8.8	7	11.2	280	280	230	200	290	235	205	235	205	295
80 x 60	8.3	8	10.6	250	250	200	180	255	210	190	210	190	265
	7.4	7	9.4	285	285	225	205	290	235	215	235	215	300
	6.4	6	8.1	330	330	265	240	335	270	250	270	250	345
75 x 50	7.4	8	9.4	250	250	205	180	260	210	185	210	185	265
	5.7	6	7.2	330	330	270	235	340	275	240	275	240	345
65 x 50	6.8	8	8.6	250	250	205	185	260	210	190	210	190	265
	5.2	6	6.6	335	335	265	245	340	275	250	275	250	350
	4.4	5	5.5	395	395	315	290	405	325	295	325	295	415

Structural Tees of Universal Columns

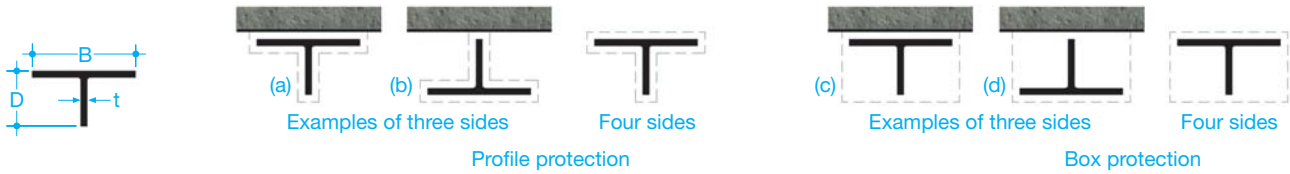

Designation		Depth of section D (mm)	Width of section B (mm)	Thickness t (mm)	Area of section (cm ²)	Profile protection			Box protection		
Serial size (mm)	Mass (kg/m)					(a) Three sides (m ⁻¹)	(b) Three sides (m ⁻¹)	Four sides (m ⁻¹)	(c) Three sides (m ⁻¹)	(d) Three sides (m ⁻¹)	Four sides (m ⁻¹)
406 x 178	118	190.5	395.0	18.5	149.9	50	75	75	50	50	80
368 x 178	101	187.3	374.4	16.8	129.0	55	85	85	60	60	85
	89	184.2	372.1	14.5	112.9	65	95	95	65	65	100
	77	181.0	370.2	12.6	97.6	75	110	110	75	75	115
	65	177.8	368.3	10.7	82.5	85	130	130	90	90	130
305 x 152	79	163.6	310.6	15.7	100.6	60	90	95	65	65	95
	69	160.3	308.7	13.8	87.3	70	105	105	70	70	110
	59	157.2	306.8	11.9	74.9	80	120	120	85	85	125
	49	153.9	304.8	9.9	61.6	95	145	145	100	100	150
254 x 127	84	144.5	265.2	19.2	106.0	50	75	75	50	50	75
	66	138.2	261.0	15.6	84.5	65	90	95	65	65	95
	54	133.4	258.3	13.0	68.3	75	110	115	75	75	115
	45	130.2	255.9	10.5	57.0	90	130	135	90	90	135
203 x 102	37	127.0	254.0	8.6	46.4	105	160	160	110	110	165
	64	120.7	213.9	18.1	81.2	55	80	80	55	55	80
	57	117.5	212.1	16.3	72.3	60	90	90	60	60	90
	50	114.3	210.3	14.5	63.4	70	100	100	70	70	100
	43	111.1	208.8	13.0	55.0	75	110	115	80	80	115
	36	108.0	206.2	10.3	45.5	90	135	135	95	95	140
	30	104.8	205.2	9.3	37.9	105	160	160	110	110	165
152 x 76	26	103.1	203.9	8.0	33.2	120	180	180	125	125	185
	23	101.6	203.2	7.3	29.4	135	200	205	140	140	205
	26	85.1	157.4	11.0	32.6	100	145	145	100	100	150
	22	83.0	155.9	9.5	28.0	110	165	170	115	115	170
	19	80.9	154.4	8.1	23.7	130	195	195	135	135	200
	15	78.7	152.9	6.6	19.1	160	235	240	160	160	240
	12	76.2	152.4	6.1	14.9	200	300	305	205	205	310

Structural Tees of Universal Beams

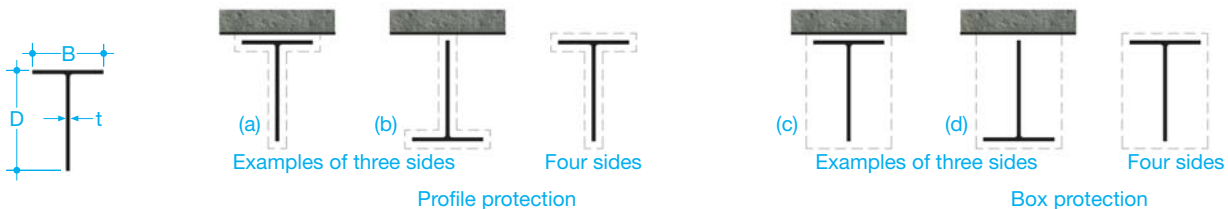

Designation		Depth of section D (mm)	Width of section B (mm)	Web thickness t (mm)	Area of section (cm ²)	Profile protection			Box protection		
Serial size (mm)	Mass (kg/m)					(a) Three sides (m ⁻¹)	(b) Three sides (m ⁻¹)	Four sides (m ⁻¹)	(c) Three sides (m ⁻¹)	(d) Three sides (m ⁻¹)	Four sides (m ⁻¹)
305 x 457	127	459.2	305.5	17.3	161.4	75	95	95	75	75	95
	112	455.2	304.1	15.9	142.6	85	105	105	85	85	105
	101	451.5	303.4	15.2	128.2	95	115	115	95	95	120
292 x 419	113	425.5	293.8	16.1	144.4	80	100	100	80	80	100
	97	420.4	292.4	14.7	123.6	90	115	115	90	90	115
	88	417.4	291.6	14.0	112.1	100	125	125	100	100	125

Continued on next page

Structural Tees of Universal Beams

Continued from previous page

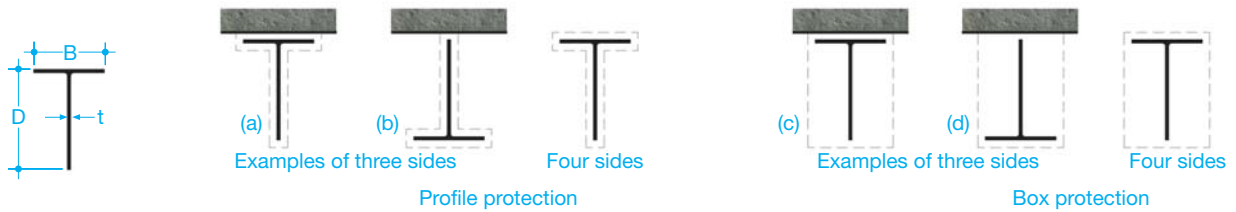

Designation		Depth of section D (mm)	Width of section B (mm)	Web thickness t (mm)	Area of section (cm ²)	Profile protection			Box protection		
Serial size (mm)	Mass (kg/m)					(a) Three sides (m ⁻¹)	(b) Three sides (m ⁻¹)	Four sides (m ⁻¹)	(c) Three sides (m ⁻¹)	(d) Three sides (m ⁻¹)	Four sides (m ⁻¹)
267 x 381	99	384.8	268.0	15.6	125.4	80	100	105	85	85	105
	87	381.0	266.7	14.3	110.2	90	115	115	90	90	120
	74	376.9	265.3	12.9	94.0	105	135	135	110	110	135
254 x 343	85	346.5	255.8	14.5	108.3	85	10	110	90	90	110
	76	343.8	254.5	13.2	96.9	95	120	120	95	95	125
	70	341.8	253.7	12.4	89.3	105	130	130	105	105	135
	63	339.0	253.0	11.7	79.8	115	145	145	115	115	150
305 x 305	119	316.5	311.8	18.6	151.9	60	80	80	60	60	85
	90	308.7	307.0	14.1	114.0	80	105	102	80	80	110
	75	304.8	304.8	11.9	95.1	95	125	125	95	95	130
229 x 305	70	308.5	230.1	13.1	89.2	95	120	120	95	95	120
	63	305.9	229.0	11.9	79.8	105	130	135	105	105	135
	57	303.7	228.2	11.2	72.2	115	145	145	115	115	145
	51	301.1	227.6	10.6	64.6	125	160	160	130	130	165
210 x 267	61	272.3	211.9	12.8	77.9	95	120	125	95	95	125
	55	269.7	210.7	11.6	69.3	105	135	135	110	110	140
	51	268.4	210.1	10.9	64.6	115	145	145	115	115	150
	46	266.6	209.3	10.2	58.9	125	160	160	125	125	160
	41	264.2	208.7	9.6	52.2	140	175	180	140	140	180
165 x 267	42	267.1	166.5	10.3	54.0	130	155	160	130	130	160
	37	264.5	165.9	9.7	47.6	145	175	180	145	145	180
	33	262.4	165.1	8.9	41.9	160	200	200	165	165	205
191 x 229	81	246.0	199.4	18.0	103.0	65	85	85	65	65	85
	67	240.3	196.7	15.3	84.9	80	100	100	80	80	105
	53	234.6	194.0	12.6	67.4	95	125	125	100	100	125
	49	233.7	192.8	11.4	62.6	105	135	135	105	105	135
	45	231.8	192.0	10.6	57.0	115	145	145	115	115	150
	41	230.1	191.3	9.9	52.3	125	160	160	125	125	160
	37	228.6	190.5	9.1	47.5	135	175	180	135	135	175
	34	226.8	189.9	8.5	42.7	150	135	135	150	150	195
152 x 229	41	232.5	153.5	10.7	52.2	115	145	145	120	120	150
	37	230.6	152.7	9.9	47.5	125	155	160	130	130	160
	34	228.6	151.9	9.1	42.7	140	175	175	145	145	180
	30	227.3	152.9	8.0	38.0	150	190	195	160	160	200
	26	224.9	152.4	7.6	33.2	180	220	225	180	180	225
178 x 203	43	208.6	181.9	10.9	54.3	110	140	140	110	110	145
	37	206.4	179.7	9.7	47.5	120	160	160	125	125	160
	34	204.7	178.8	8.8	42.7	135	175	175	140	140	180
	30	203.2	177.8	7.8	38.0	150	195	200	155	155	200
	27	201.3	177.6	7.6	34.2	165	215	220	170	170	220
140 x 203	27	203.3	143.3	7.9	34.0	160	200	200	160	160	205
	23	201.2	142.4	6.9	29.5	180	230	230	185	185	235
	20	198.6	141.8	6.3	24.7	215	270	275	220	220	275

Continued on next page

Structural Tees of Universal Beams

Continued from previous page

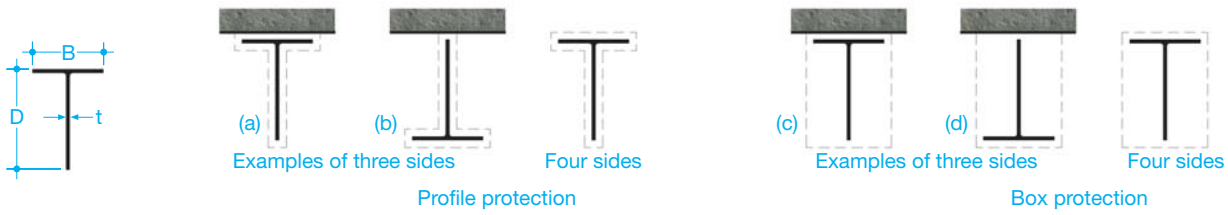

Designation		Depth of section D (mm)	Width of section B (mm)	Web thickness t (mm)	Area of section (cm ²)	Profile protection			Box protection		
Serial size (mm)	Mass (kg/m)					(a) Three sides (m ⁻¹)	(b) Three sides (m ⁻¹)	Four sides (m ⁻¹)	(c) Three sides (m ⁻¹)	(d) Three sides (m ⁻¹)	Four sides (m ⁻¹)
171 x 178	34	182.0	173.2	9.1	42.7	125	160	165	125	125	165
	29	179.3	172.1	8.0	36.1	145	190	190	145	145	195
	26	177.8	171.5	7.3	32.3	160	210	215	165	165	215
	23	176.0	171.0	6.9	28.5	180	240	240	185	185	245
127 x 178	20	176.4	126.0	6.5	24.7	190	240	240	195	195	245
	17	174.2	125.4	5.9	20.9	225	280	285	225	225	285
165 x 152	27	155.4	166.8	7.7	34.2	140	185	185	140	140	190
	23	153.5	165.7	6.7	29.5	160	210	215	160	160	215
	20	151.9	165.1	6.1	25.8	180	240	245	180	180	245
127 x 152	24	155.2	125.2	8.9	30.4	140	180	180	145	145	185
	21	153.3	124.3	8.0	26.6	160	200	205	160	160	210
	19	151.9	123.5	7.2	23.7	175	225	230	180	180	230
102 x 152	17	156.3	102.4	6.6	20.9	195	240	245	200	200	245
	14	154.5	101.9	6.1	18.2	220	275	280	225	225	280
	13	152.4	101.6	5.8	15.7	255	320	320	260	260	325
146 x 127	22	129.8	147.3	7.3	27.6	145	195	200	150	150	200
	19	128.0	146.4	6.4	23.7	165	225	230	170	170	230
	16	125.7	146.1	6.1	20.0	195	265	270	200	200	270
102 x 127	14	130.2	102.1	6.4	18.1	195	250	250	200	200	255
	13	128.5	101.9	6.1	16.1	220	280	280	220	220	285
	11	127.0	101.6	5.8	14.2	245	315	320	250	250	325
133 x 102	15	103.4	133.8	6.3	19.0	175	245	245	180	180	250
	13	101.6	133.4	5.8	16.1	205	285	290	210	210	290

Rolled Tees

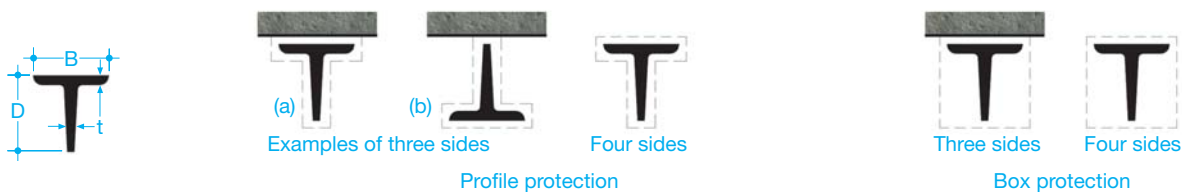

Designation		Depth of section D (mm)	Width of section B (mm)	Thickness t (mm)	Area of section (cm ²)	Profile protection			Box protection	
Serial size (mm)	Mass (kg/m)					(a) Three sides (m ⁻¹)	(b) Three sides (m ⁻¹)	Four sides (m ⁻¹)	Three sides (m ⁻¹)	Four sides (m ⁻¹)
51 x 51	6.9	50.8	50.8	9.5	8.8	175	220	230	175	230
	4.8	50.8	50.8	6.4	6.1	250	325	335	250	335
44 x 44	4.1	44.4	44.4	6.4	5.2	255	325	340	255	340
	3.1	44.4	44.4	4.8	4.0	335	430	445	335	445

Square Hollow Sections

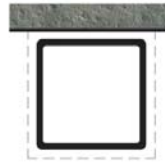
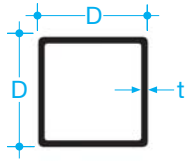

Three sides

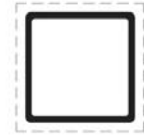

Four sides

Profile or box protection

Designation		Thickness t (mm)	Area of section (cm ²)	Profile or box protection	
Size D x D (mm)	Mass (kg/m)			Three sides (m ⁻¹)	Four sides (m ⁻¹)
20 x 20	1.1	2.0	1.4	425	565
	1.4	2.5	1.7	350	465
25 x 25	1.4	2.0	1.8	410	550
	1.7	2.5	2.2	340	450
	2.0	3.0	2.6	290	385
	2.2	3.2	2.7	275	365
30 x 30	2.1	2.5	2.7	330	440
	2.5	3.0	3.2	280	375
	2.6	3.2	3.4	265	355
40 x 40	2.9	2.5	3.7	325	430
	3.5	3.0	4.4	275	365
	3.7	3.2	4.7	260	345
	4.0	3.6	5.1	235	315
	4.5	4.0	5.7	210	280
50 x 50	5.4	5.0	6.9	175	235
	3.7	2.5	4.7	320	425
	4.4	3.0	5.6	270	355
	4.7	3.2	5.9	255	335
	5.1	3.6	6.5	230	305
	5.7	4.0	7.3	205	275
	7.0	5.0	8.9	170	225
60 x 60	8.5	6.3	10.8	140	185
	5.4	3.0	6.8	265	355
	5.7	3.2	7.2	250	330
	6.3	3.6	8.0	225	300
	7.0	4.0	8.9	205	270
	8.5	5.0	10.9	165	220
70 x 70	10.5	6.3	13.3	135	180
	12.8	8.0	16.3	110	145
	6.3	3.0	8.0	260	350
	6.6	3.2	8.4	250	335
	7.5	3.6	9.5	220	295
80 x 80	8.2	4.0	10.4	205	270
	10.1	5.0	12.9	165	215
	12.5	6.3	15.9	130	175
	15.3	8.0	19.5	110	145
	7.2	3.0	9.2	260	350
	7.6	3.2	9.7	250	330
90 x 90	8.6	3.6	10.9	220	295
	9.4	4.0	12.0	200	270
	11.7	5.0	14.9	160	215
	14.4	6.3	18.4	130	175
	17.8	8.0	22.7	105	140
	9.7	3.6	12.4	220	290
100 x 100	10.7	4.0	13.6	200	265
	13.3	5.0	16.9	160	215
	16.4	6.3	20.9	130	170
	20.4	8.0	25.9	105	140
	10.8	3.6	13.7	220	295
120 x 120	12.0	4.0	15.3	195	260
	14.8	5.0	18.9	160	210
	18.4	6.3	23.4	130	170
	22.9	8.0	29.1	105	135
	27.9	10.0	35.5	85	115
	14.4	4.0	18.4	195	260
120 x 120	18.0	5.0	22.9	155	210
	22.3	6.3	28.5	125	170
	27.9	8.0	35.5	100	135
	34.2	10.0	43.5	85	110
	41.6	12.5	53.0	70	90

Designation		Thickness t (mm)	Area of section (cm ²)	Profile or box protection	
Size D x D (mm)	Mass (kg/m)			Three sides (m ⁻¹)	Four sides (m ⁻¹)
140 x 140	21.1	5.0	26.9	155	210
	26.3	6.3	33.5	125	165
	32.9	8.0	41.9	100	135
	40.4	10.0	51.5	80	110
	49.5	12.5	63.0	65	90
150 x 150	22.7	5.0	28.9	155	210
	28.3	6.3	36.0	125	165
	35.4	8.0	45.1	100	135
	43.6	10.0	55.5	80	110
	53.4	12.5	68.0	65	90
160 x 160	66.4	16.0	84.5	55	70
	24.1	5.0	30.7	160	210
	30.1	6.3	38.3	125	170
	37.6	8.0	48.0	100	135
	46.3	10.0	58.9	85	110
180 x 180	56.6	12.5	72.1	70	90
	63.3	14.2	80.7	60	80
	70.2	16.0	89.4	55	75
	27.3	5.0	34.7	155	210
	34.2	6.3	43.6	125	165
	43.0	8.0	54.7	100	130
200 x 200	53.0	10.0	67.5	80	105
	65.2	12.5	83.0	65	85
	72.2	14.2	92.0	60	80
	81.4	16.0	104.0	50	70
	30.4	5.0	38.7	155	210
250 x 250	38.2	6.3	48.6	125	165
	48.0	8.0	61.1	100	130
	59.3	10.0	75.5	80	105
	73.0	12.5	93.0	65	85
	81.1	14.2	103.0	60	80
260 x 260	91.5	16.0	117.0	50	70
	48.1	6.3	61.2	125	165
	60.5	8.0	77.1	95	130
	75.0	10.0	95.5	80	105
	92.6	12.5	118.0	65	85
	117.0	16.0	149.0	50	65
300 x 300	49.9	6.3	63.5	125	165
	62.8	8.0	80.0	100	130
	77.7	10.0	98.9	80	105
	95.8	12.5	122.0	65	85
	108.0	14.2	137.0	60	75
	120.0	16.0	153.0	55	70
350 x 350	57.8	6.3	73.6	125	165
	72.8	8.0	92.8	100	130
	90.7	10.0	116.0	80	105
	112.0	12.5	143.0	65	85
	126.0	14.2	160.0	60	75
	142.0	16.0	181.0	50	65
400 x 400	85.4	8.0	109.0	100	130
	106.0	10.0	135.0	75	105
	132.0	12.5	168.0	60	85
	148.0	14.2	189.0	55	75
	167.0	16.0	213.0	50	65
	97.9	8.0	125.0	100	130
400 x 400	122.0	10.0	156.0	75	105
	152.0	12.5	193.0	60	85
	170.0	14.2	217.0	55	75
	192.0	16.0	245.0	50	65
	235.0	20.0	300.0	40	55

Rectangular Hollow Sections

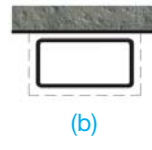
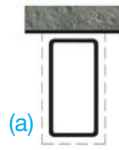
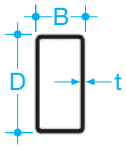

(a)

(b)

Examples of three sides

Four sides

Profile or box protection

Designation		Thickness t (mm)	Area of section (cm ²)	Profile or box protection		
Size D x B (mm)	Mass (kg/m)			(a) Three sides (m ⁻¹)	(b) Three sides (m ⁻¹)	Four sides (m ⁻¹)
50 x 50	2.7	2.5	3.5	360	290	430
	3.2	3.0	4.1	305	245	365
	3.4	3.2	4.3	290	230	345
50 x 30	2.9	2.5	3.7	350	295	430
	3.5	3.0	4.4	290	250	365
	3.7	3.2	4.7	280	235	345
	4.0	3.6	5.1	255	215	315
	4.5	4.0	5.7	230	195	280
	5.4	5.0	6.9	190	160	235
	3.7	2.5	4.7	340	295	425
60 x 40	4.4	3.0	5.6	285	250	355
	4.7	3.2	5.9	270	235	335
	5.1	3.6	6.5	245	215	305
	5.7	4.0	7.3	220	190	275
	7.0	5.0	8.9	180	160	225
	8.5	6.3	10.8	150	130	185
	5.3	3.0	6.8	295	235	355
80 x 40	5.7	3.2	7.2	275	220	330
	6.3	3.6	8.0	250	200	300
	7.0	4.0	8.9	225	180	270
	8.5	5.0	10.9	185	145	220
	10.5	6.3	13.3	150	120	180
	12.8	8.0	16.3	125	100	145
	6.3	3.0	8.0	290	240	350
90 x 50	6.6	3.2	8.4	275	225	335
	7.5	3.6	9.5	240	200	295
	8.2	4.0	10.4	225	185	270
	10.1	5.0	12.9	180	145	215
	12.5	6.3	15.9	145	120	175
	15.3	8.0	19.5	120	95	145
	6.8	3.0	8.6	290	235	350
100 x 50	7.2	3.2	9.1	275	220	330
	8.0	3.6	10.1	250	200	300
	8.9	4.0	11.3	220	175	265
	10.9	5.0	13.9	180	145	215
	13.4	6.3	17.1	145	115	175
	16.6	8.0	21.1	120	95	145
	7.2	3.0	9.2	285	240	350
100 x 60	7.6	3.2	9.7	270	230	330
	8.6	3.6	10.9	240	200	295
	9.4	4.0	12.0	220	185	270
	11.7	5.0	14.9	175	150	215
	14.4	6.3	18.4	140	120	175
	17.8	8.0	22.7	115	95	140
	9.7	3.6	12.4	240	195	290
120 x 60	10.7	4.0	13.6	220	180	265
	13.3	5.0	16.9	180	140	215
	16.4	6.3	20.9	145	115	170
	20.4	8.0	25.9	115	95	140
	24.3	10.0	30.9	100	80	120
	10.8	3.6	13.7	235	205	295
	11.9	4.0	15.2	210	185	265
120 x 80	14.8	5.0	18.9	170	150	210
	18.4	6.3	23.4	135	120	170
	22.9	8.0	29.1	110	95	135
	27.9	10.0	35.5	90	80	115
	15.1	4.0	19.2	210	185	260
	18.7	5.0	23.9	165	145	210
	23.3	6.3	29.7	135	120	170
150 x 100	29.1	8.0	37.1	110	95	135
	35.7	10.0	45.5	90	75	110
	43.6	12.5	55.5	70	65	90
	16.6	4.0	21.2	200	190	260
	20.6	5.0	26.2	165	155	210
	25.6	6.3	32.6	130	125	170
	32.0	8.0	40.8	105	100	135
150 x 125	39.2	10.0	49.9	85	80	110
	47.7	12.5	60.8	70	70	90

Rectangular Hollow Sections

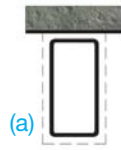
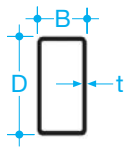

(a)

(b)

Examples of three sides

Four sides

Profile or box protection

Designation		Thickness t (mm)	Area of section (cm ²)	Profile or box protection		
Size D x B (mm)	Mass (kg/m)			(a) Three sides (m ⁻¹)	(b) Three sides (m ⁻¹)	Four sides (m ⁻¹)
160 x 80	14.4	4.0	18.4	220	175	260
	18.0	5.0	22.9	175	140	210
	22.3	6.3	28.5	140	110	170
	27.9	8.0	35.5	115	90	135
	34.2	10.0	43.5	90	75	110
	41.6	12.5	53.0	75	60	90
200 x 100	22.6	5.0	28.7	175	140	210
	28.1	6.3	35.8	140	115	170
	35.1	8.0	44.8	110	90	135
	43.1	10.0	54.9	95	75	110
	52.7	12.5	67.1	75	60	90
	65.2	16.0	83.0	60	50	75
200 x 120	24.1	5.0	30.7	170	145	210
	30.1	6.3	38.3	140	115	170
	37.6	8.0	48.0	110	95	135
	46.3	10.0	58.9	90	75	110
	56.6	12.5	72.1	75	65	90
	63.3	14.2	80.7	65	55	80
200 x 150	70.2	16.0	89.4	60	50	75
	26.5	5.0	33.7	165	150	210
	33.0	6.3	42.1	135	120	170
	41.4	8.0	52.8	105	95	135
	41.0	10.0	64.9	80	80	110
	62.5	12.5	79.6	70	65	90
250 x 100	70.0	14.2	89.2	65	60	80
	77.7	16.0	99.0	55	55	70
	26.5	5.0	33.7	180	135	210
	33.0	6.3	42.1	145	110	170
	41.4	8.0	52.8	115	85	135
	51.0	10.0	64.9	95	70	110
250 x 150	62.5	12.5	79.6	75	60	90
	70.0	14.2	89.2	70	50	80
	77.7	16.0	99.0	65	45	70
	30.4	5.0	38.7	170	145	210
	38.0	6.3	48.4	135	115	165
	47.7	8.0	60.8	110	90	135
250 x 200	58.8	10.0	74.9	90	75	110
	72.3	12.5	92.1	75	60	90
	81.1	14.2	103.0	65	55	80
	90.3	16.0	115.0	60	50	70
	66.7	10.0	84.9	85	80	110
	82.1	12.5	105.0	70	65	90
260 x 140	92.3	14.2	118.0	60	55	80
	30.4	5.0	38.7	170	140	210
	38.0	6.3	48.4	140	115	165
	47.7	8.0	60.8	110	90	135
	58.8	10.0	74.9	90	75	110
	72.3	12.5	92.1	75	60	90
300 x 100	81.1	14.2	103.0	65	55	80
	90.3	16.0	115.0	60	50	70
	30.4	5.0	38.7	180	130	210
	38.0	6.3	48.4	145	105	156
	47.7	8.0	60.8	115	85	135
	58.8	10.0	74.9	95	70	110
300 x 150	72.3	12.5	92.1	80	55	90
	81.1	14.2	103.0	70	50	80
	90.3	16.0	115.0	65	45	70
	54.0	8.0	68.8	110	90	130
	66.7	10.0	84.9	90	70	110
	82.1	12.5	105.0	75	60	90
300 x 150	92.3	14.2	118.0	65	55	80
	103.0	16.0	131.0	60	50	70

Rectangular Hollow Sections

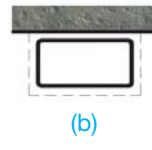
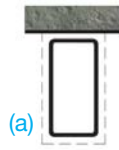
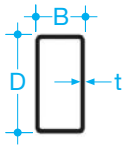

(a)

(b)

Examples of three sides

Four sides

Profile or box protection

Designation		Thickness t (mm)	Area of section (cm ²)	Profile or box protection			
Size D x B (mm)	Mass (kg/m)			(a) Three sides (m ²)	(b) Three sides (m ²)	Four sides (m ²)	
300 x 200	38.3	5.0	48.7	165	145	205	
	47.9	6.3	61.0	135	115	165	
	60.3	8.0	76.8	105	95	130	
	74.5	10.0	94.9	85	75	105	
	91.9	12.5	117.0	70	60	85	
	103.0	14.2	132.0	60	55	75	
	115.0	16.0	147.0	55	50	70	
300 x 250	52.8	6.3	67.3	130	120	165	
	66.5	8.0	84.8	100	95	130	
	82.4	10.0	105.0	85	80	105	
	102.0	12.5	130.0	65	65	85	
	115.0	14.2	146.0	60	55	75	
	128.0	16.0	163.0	55	50	70	
	350 x 150	47.9	6.3	61.0	140	110	165
60.3		8.0	76.8	110	85	130	
74.5		10.0	94.9	90	70	105	
91.9		12.5	117.0	75	55	85	
103.0		14.2	132.0	65	50	75	
115.0		16.0	147.0	60	45	70	
350 x 250		57.8	6.3	73.6	130	115	165
	72.8	8.0	92.8	105	95	130	
	90.2	10.0	115.0	85	75	105	
	112.0	12.5	142.0	70	60	85	
	126.0	14.2	160.0	60	55	75	
	141.0	16.0	179.0	55	50	70	
	400 x 120	49.9	6.3	63.5	145	100	165
62.8		8.0	80.0	115	80	130	
77.7		10.0	98.9	95	65	105	
95.8		12.5	122.0	75	55	85	
108.0		14.2	137.0	70	50	80	
120.0		16.0	153.0	65	45	70	
400 x 150		52.8	6.3	67.3	145	105	165
	66.5	8.0	84.8	115	85	130	
	82.4	10.0	105.0	90	70	105	
	102.0	12.5	130.0	75	55	85	
	115.0	14.2	146.0	65	50	75	
	128.0	16.0	163.0	60	45	70	
	400 x 200	57.8	6.3	73.6	140	110	165
72.8		8.0	92.8	110	90	130	
90.2		10.0	115.0	90	70	105	
112.0		12.5	142.0	70	60	85	
126.0		14.2	160.0	65	50	75	
141.0		16.0	179.0	60	45	70	
400 x 300		85.4	8.0	109.0	105	95	130
	106.0	10.0	135.0	85	75	105	
	131.0	12.5	167.0	70	60	85	
	148.0	14.2	189.0	60	55	75	
	166.0	16.0	211.0	55	50	70	
	450 x 250	85.4	8.0	109.0	105	90	130
		106.0	10.0	135.0	85	70	105
131.0		12.5	167.0	70	60	85	
148.0		14.2	189.0	65	50	75	
166.0		16.0	211.0	55	45	70	
500 x 200		85.4	8.0	109.0	110	85	130
		106.0	10.0	135.0	90	70	105
	131.0	12.5	167.0	75	55	85	
	148.0	14.2	189.0	65	50	75	
	166.0	16.0	211.0	60	45	70	
	500 x 300	97.9	8.0	125.0	105	90	130
		122.0	10.0	155.0	85	75	105
151.0		12.5	192.0	70	60	85	
170.0		14.2	217.0	60	50	75	
191.0		16.0	249.0	55	45	70	
235.0		20.0	300.0	45	40	55	

Circular Hollow Sections

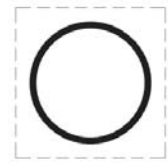
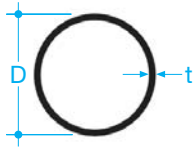

Profile protection

Box protection

Designation		Thickness t (mm)	Area of section (cm ²)	Profile or box protection (m ⁻¹)	
Outside diameter D (mm)	Mass (kg/m)				
21.3	1.2	2.6	1.5	440	
	1.3	2.9	1.7	400	
	1.4	3.2	1.8	370	
26.9	1.6	2.9	2.0	425	
	1.7	2.9	2.2	385	
	1.9	3.2	2.4	355	
33.7	2.0	2.6	2.5	415	
	2.2	2.9	2.8	375	
	2.4	3.2	3.1	345	
	2.7	3.6	3.4	310	
42.4	2.9	4.0	3.7	285	
	2.6	2.6	3.3	410	
	2.8	2.9	3.6	370	
	3.1	3.2	3.9	340	
	3.4	3.6	4.4	305	
48.3	3.8	4.0	4.8	275	
	4.6	5.0	5.9	230	
	3.3	2.9	4.1	365	
	3.6	3.2	4.5	355	
60.3	4.0	3.6	5.1	300	
	4.4	4.0	5.6	275	
	5.3	5.0	6.8	225	
	4.1	2.9	5.2	360	
76.1	4.5	3.2	5.7	330	
	5.0	3.6	6.4	295	
	5.6	4.0	7.1	270	
	6.8	5.0	8.7	220	
88.9	5.2	2.9	6.7	358	
	5.8	3.2	7.3	325	
	6.4	3.6	8.2	290	
	7.1	4.0	9.1	265	
	8.8	5.0	11.2	215	
114.3	10.8	6.3	13.8	175	
	6.2	2.9	7.8	355	
	6.8	3.2	8.6	325	
	7.6	3.6	9.7	290	
	8.4	4.0	10.7	260	
139.7	10.3	5.0	13.2	210	
	12.8	6.3	16.3	170	
	8.8	3.2	11.2	320	
	9.8	3.6	12.5	285	
	10.9	4.0	13.9	260	
168.3	13.5	5.0	17.2	210	
	16.6	6.3	21.4	170	
	10.8	3.2	13.7	320	
	12.1	3.6	15.4	285	
	13.4	4.0	17.1	255	
	16.6	5.0	21.2	205	
193.7	20.7	6.3	26.4	165	
	26.0	8.0	33.1	135	
	32.0	10.0	40.7	110	
	20.1	5.0	25.7	205	
	25.2	6.3	32.1	165	
	31.6	8.0	40.3	130	
508.0	39.0	10.0	49.7	105	
	48.0	12.5	61.2	85	
	23.3	5.0	29.6	205	
	25.1	5.4	31.9	190	
	29.1	6.3	37.1	165	
	36.6	8.0	46.7	130	
	45.3	10.0	57.7	105	
508.0	55.9	12.5	71.2	85	
	70.1	16.0	89.3	70	
	508.0	26.4	5.0	33.6	205
		33.1	6.3	42.1	165
		41.6	8.0	53.1	130
		51.6	10.0	65.7	105
		63.7	12.5	81.1	85
71.8		14.2	91.4	75	
80.1		16.0	102.0	65	
508.0	98.2	20.0	125.0	55	
	29.5	5.0	37.6	205	
	37.0	6.3	47.1	165	
	46.7	8.0	59.4	130	
	57.8	10.0	73.7	105	
	71.5	12.5	91.1	85	
	80.6	14.2	103.0	75	
508.0	90.2	16.0	115.0	65	
	111.0	20.0	141.0	55	
	33.0	5.0	42.1	205	
	41.4	6.3	52.8	160	
	52.3	8.0	66.6	130	
	64.9	10.0	82.6	105	
	80.3	12.5	102.0	85	
508.0	90.6	14.2	115.0	75	
	101.0	16.0	129.0	65	
	125.0	20.0	159.0	55	
	153.0	25.0	195.0	45	
	39.3	5.0	50.1	205	
	49.3	6.3	62.9	160	
	62.3	8.0	79.4	130	
508.0	77.4	10.0	98.6	105	
	96.0	12.5	122.0	85	
	108.0	14.2	138.0	75	
	121.0	16.0	155.0	65	
	150.0	20.0	191.0	55	
	184.0	25.0	235.0	45	
	54.3	6.3	69.1	160	
508.0	68.6	8.0	87.4	130	
	85.2	10.0	109.0	100	
	106.0	12.5	135.0	85	
	120.0	14.2	152.0	75	
	134.0	16.0	171.0	65	
	166.0	20.0	211.0	55	
	204.0	25.0	260.0	45	
508.0	62.2	6.3	79.2	160	
	78.6	8.0	100.0	130	
	97.8	10.0	125.0	100	
	121.0	12.5	155.0	80	
	137.0	14.2	175.0	75	
	154.0	16.0	196.0	65	
	191.0	20.0	243.0	55	
508.0	235.0	25.0	300.0	45	
	295.0	32.0	376.0	35	
	70.0	6.3	89.2	160	
	88.6	8.0	113.0	130	
	110.0	10.0	140.0	105	
	137.0	12.5	175.0	80	
	155.0	14.2	198.0	75	
508.0	174.0	16.0	222.0	65	
	216.0	20.0	275.0	50	
	266.0	25.0	339.0	40	
	335.0	32.0	427.0	35	
	411.0	40.0	524.0	25	
	77.9	6.3	99.3	160	
	98.6	8.0	126.0	125	
508.0	123.0	10.0	156.0	100	
	153.0	12.5	195.0	80	
	173.0	14.2	220.0	75	
	194.0	16.0	247.0	65	

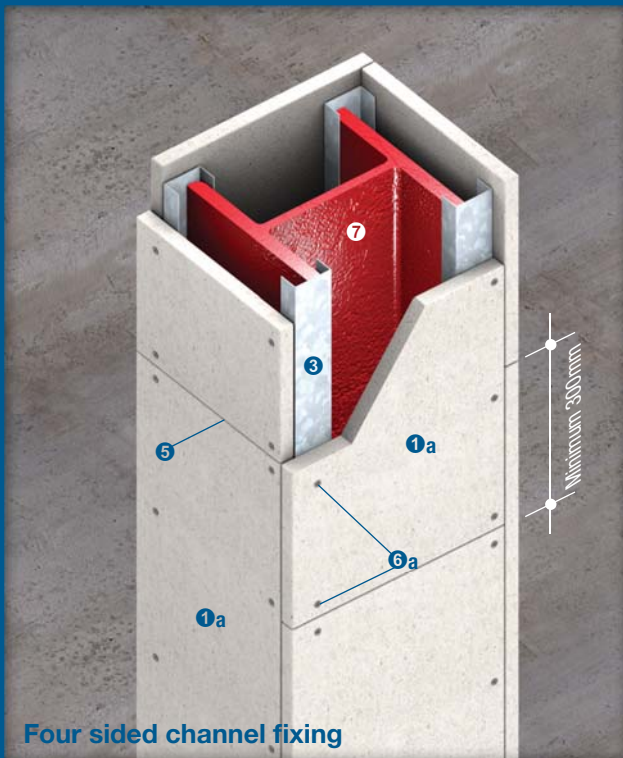

Four sided channel fixing

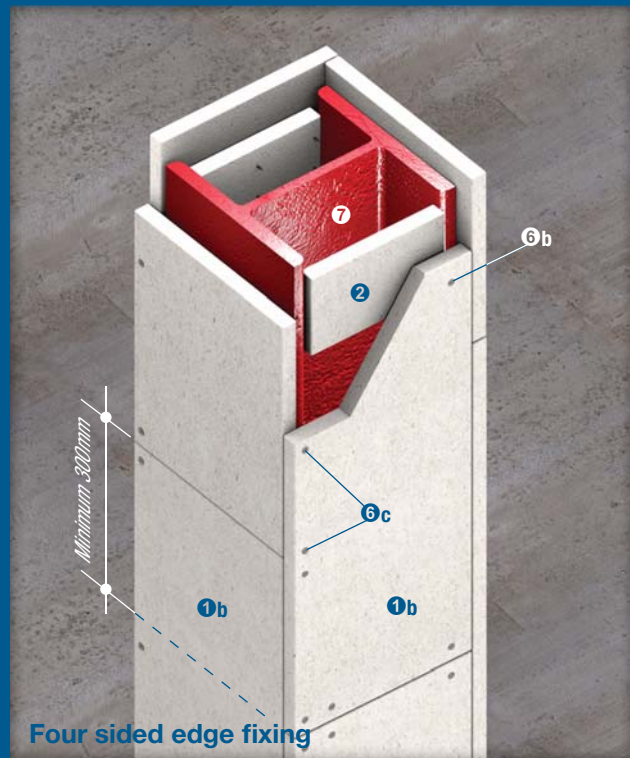

Four sided edge fixing

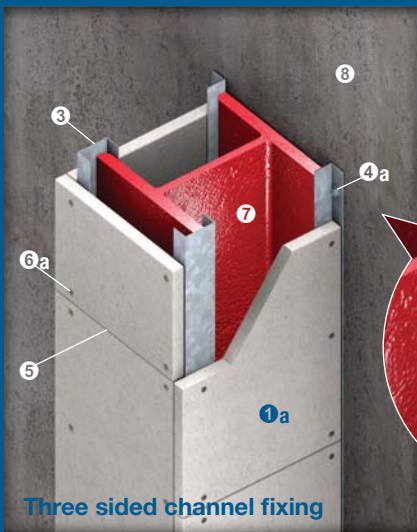

Three sided channel fixing

Up to 120/- fire resistance in accordance with the requirements of BS 476: Part 21: 1987 and AS 1530: Part 4: 2005, and up to 180/- fire resistance in accordance with the requirements of ASTM E119: 2007

①a PROMATECT®-H board, thickness in accordance with the Hp/A Ratio tables on page 25

①b PROMATECT®-H board, $\geq 15\text{mm}$ of thickness in accordance with the Hp/A Ratio tables on page 25

② PROMATECT®-H soldiers 100mm wide, minimum thickness similar to the board thickness of ①b

③ Continuous galvanised steel channel 19mm x 38mm x 19mm x 1.6mm thick or similar, leg of each channel is located against inner surface of flange

④a Continuous galvanised steel angles minimum 32mm x 19mm x 0.9mm thick or similar fixed to the wall using non combustible proprietary anchors at nominal 500mm centres

④b Continuous galvanised steel angles minimum 32mm x 19mm x 0.9mm thick or similar fixed to the flange using Teks screws, shot fired nails or welding. Secure edges of side boards at 200mm centres

⑤ Horizontal joints in adjacent board sides to be staggered at minimum 300mm

For wide columns, it is advisable to include a PROMATECT®-H cover strip behind the joints within the web of the steel column to provide additional impact resistance

⑥a Self-drilling or self-tapping drywall screws fixed to channel/angle at nominal 200mm centres. Screw length should be additional 20mm of the board thickness

⑥b Self-drilling or self-tapping drywall screws fixed to soldiers at nominal 100mm centres. Screw length should be additional 20mm of the board thickness

⑥c Fixings in accordance with table below. Care should be taken not to overtighten the screws. When edge fixing it is advisable to drill pilot holes, particularly with 15mm thick boards

PROMATECT®-H board thickness	Deep threaded drywall screws preferably with ribbed heads at 200mm centres	Steel wire staples at 100mm centres
15mm	No. 6 x 40mm	44/10/1mm
20mm	No. 10 x 55mm	50/10/1mm
25mm	No. 10 x 60mm	50/10/1mm

NOTE: <15mm thick boards cannot be edge fixed. Please consult Promat for further guidance on steel wire staple fixing

⑦ Structural steel column

⑧ Concrete wall substrate

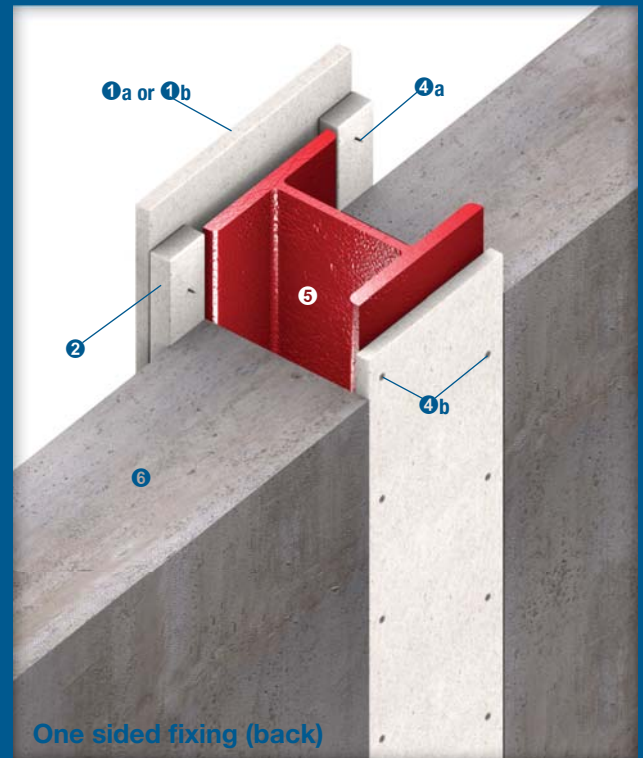
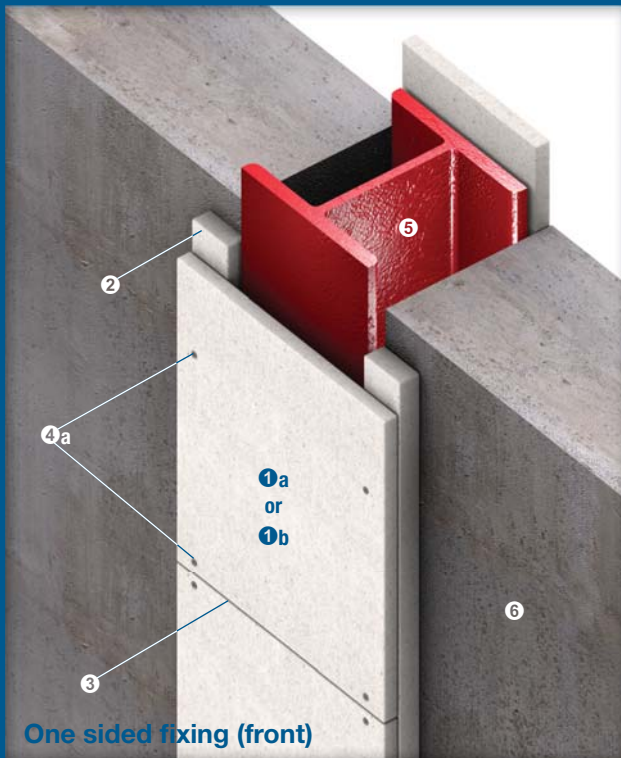

Up to 120/- fire resistance in accordance with the requirements of BS 476: Part 21: 1987 and AS 1530: Part 4: 2005, and up to 180/- fire resistance in accordance with the requirements of ASTM E119: 2007

- ①a PROMATECT®-H board, thickness in accordance with the Hp/A Ratio tables on page 25
- ①b PROMATECT®-H board, ≥15mm of thickness in accordance with the Hp/A Ratio tables on page 25
- ② PROMATECT®-H spacer strips, fixed to substrate using non combustible proprietary anchors at 300mm centres with minimum 50mm overlap to either side of steel section
- ③ Horizontal joints in adjacent board sides to be staggered at minimum 300mm
For wide columns, it is advisable to include a PROMATECT®-H cover strip behind the joints within the web of the steel column to provide additional impact resistance
- ④a Self-drilling or self-tapping screws at 200mm centres or steel wire staples at 100mm centres, fixed the main PROMATECT®-H board onto the spacer strips
- ④b Two rows of self-drilling, self-tapping Teks screws fixed to steel column at nominal 300mm staggered centres
- ⑤ Structural steel column
- ⑥ Concrete wall substrate

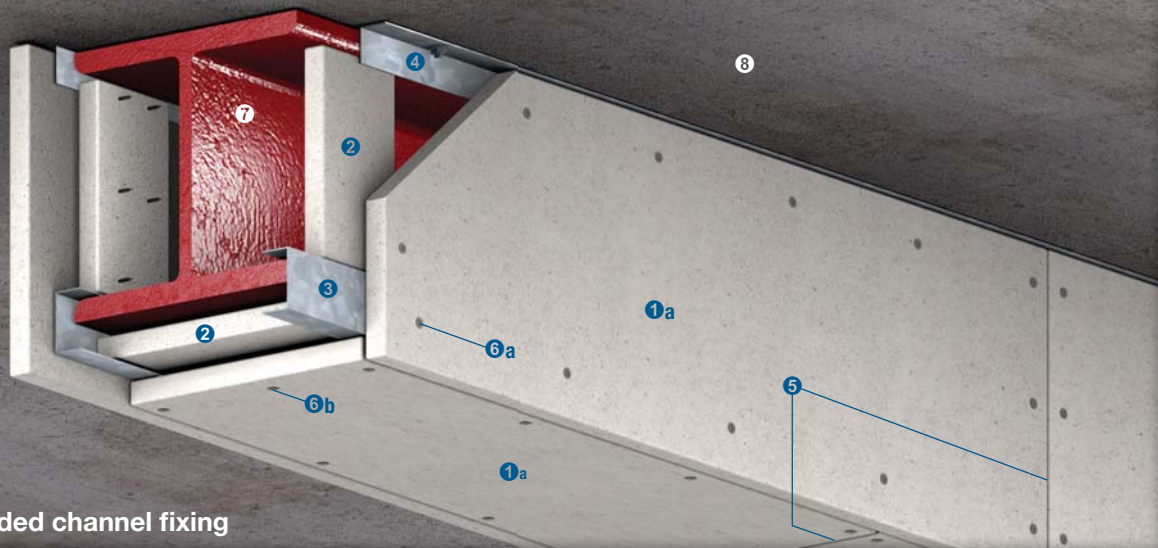

Three sided channel fixing

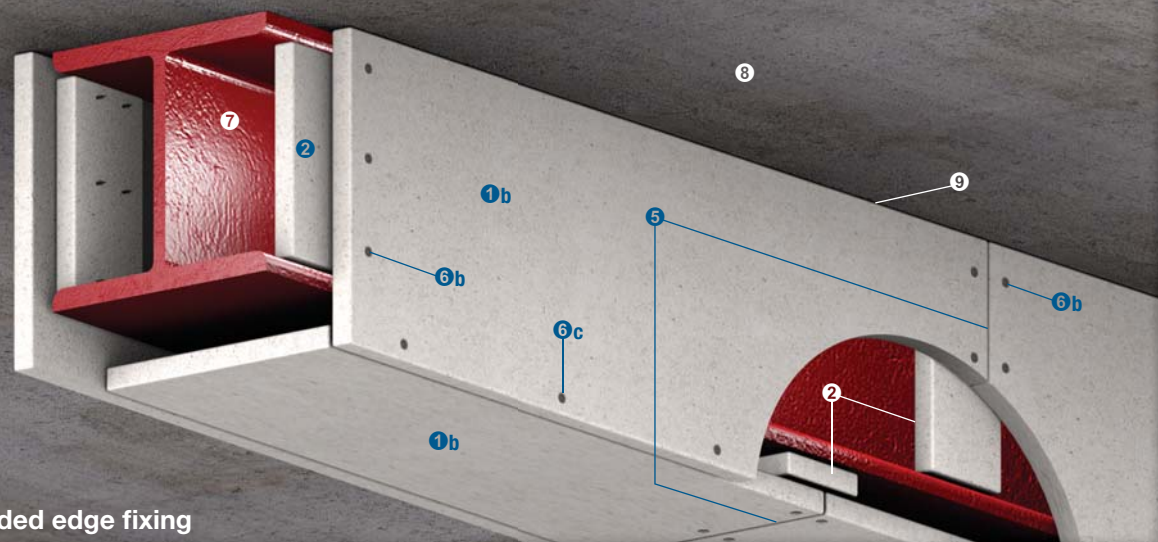

Three sided edge fixing

Up to 120/-/- fire resistance in accordance with the requirements of BS 476: Part 21: 1987 and AS 1530: Part 4: 2005, and up to 180/-/- fire resistance in accordance with the requirements of ASTM E119: 2007

- ①a PROMATECT®-H board, thickness in accordance with the Hp/A ratio tables on page 25
- ①b PROMATECT®-H board, ≥ 15 mm of thickness in accordance with the Hp/A ratio tables on page 25
- ② PROMATECT®-H soldiers 100mm wide, minimum thickness similar to the board thickness of ①b, fixed within the web of the steel beam at maximum 1220mm centres behind the board joints using screws at 100mm centres or staples at 50mm centres
For deep beams clad with thicker boards for greater fire resistance, it is advisable to fix the soldiers at nominal 600mm centres in order to reduce the load on the soldiers. For steel beams greater than 600mm deep, a T-section soldier should be used to provide a stronger support
- ③ Continuous galvanised steel channel 19mm x 38mm x 19mm x 1.6mm thick or similar located at the bottom flange, leg of each channel is facing inner surface of the flange
- ④ Continuous galvanised steel angles minimum 32mm x 19mm x 0.9mm thick or similar beneath the upper flange OR fixed to the floor slab using non combustible proprietary anchors at nominal 500mm centres

- ⑤ Vertical and horizontal joints in adjacent board sides to be staggered at minimum 300mm
- ⑥a Self-drilling or self-tapping drywall screws fixed to channel/angle at nominal 200mm centres. Screw length should be additional 20mm of the board thickness
- ⑥b Self-drilling or self-tapping drywall screws fixed to soldiers at nominal 100mm centres. Screw length should be additional 20mm of the board thickness
- ⑥c Fixings in accordance with the table on page 20. Care should be taken not to overtighten the screws. When edge fixing it is advisable to drill pilot holes, particularly with 15mm thick boards
NOTE: <15mm thick boards cannot be edge fixed
- ⑦ Structural steel beam
- ⑧ Floor slab
- ⑨ Caulk all edges between the board and the floor slab with PROMASEAL® AN Acrylic Sealant, depth in accordance with the required board thickness

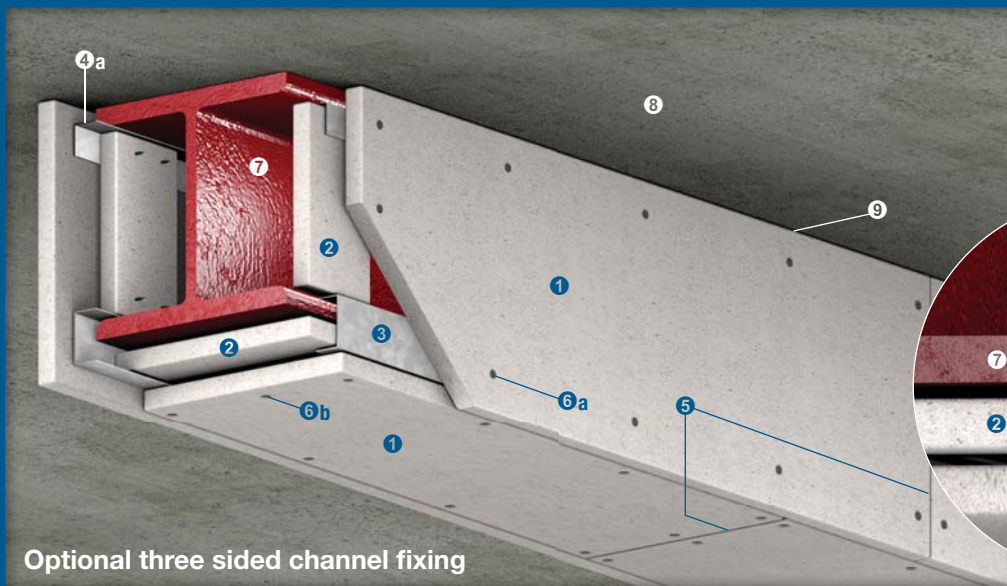

Optional three sided channel fixing

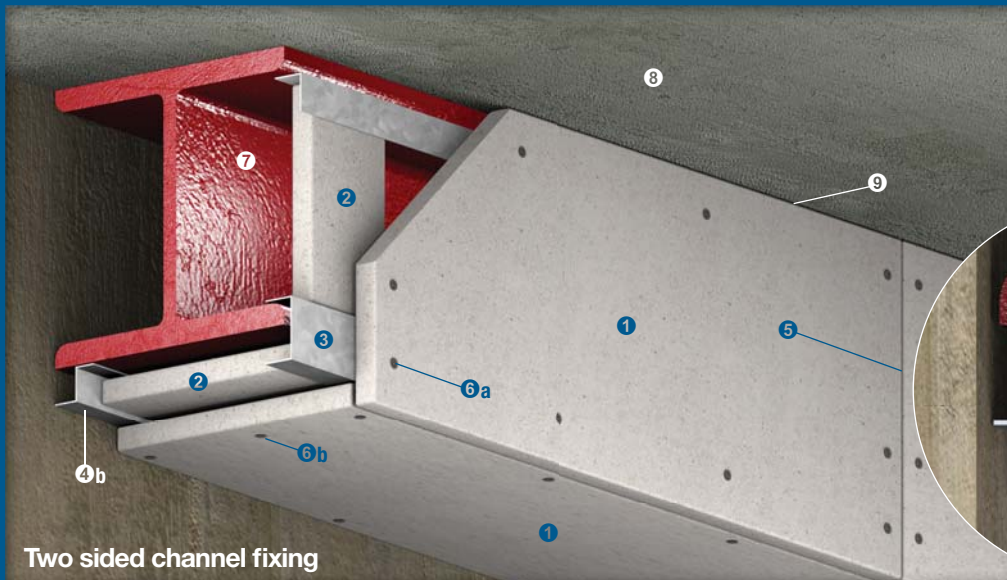
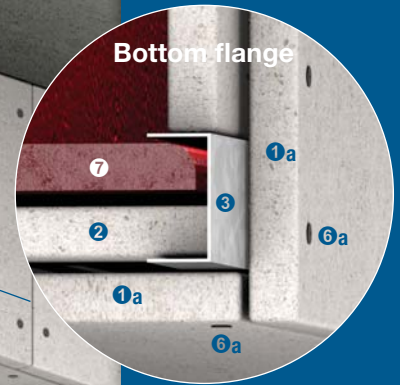

Two sided channel fixing

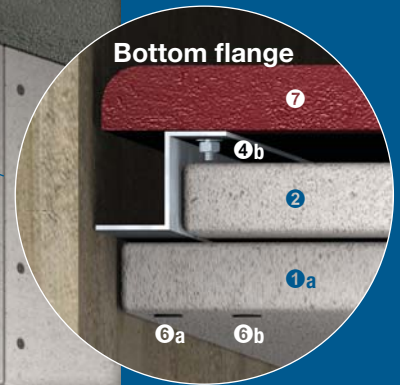

Up to 120/-/- fire resistance in accordance with the requirements of BS 476: Part 21: 1987 and AS 1530: Part 4: 2005, and up to 180/-/- fire resistance in accordance with the requirements of ASTM E119: 2007

- ① PROMATECT®-H board, thickness in accordance with the Hp/A ratio tables on page 25
- ② PROMATECT®-H soldiers 100mm wide, minimum thickness similar to the board thickness of ①, fixed within the web of the steel beam at maximum 1220mm centres behind the board joints using screws at 100mm centres or staples at 50mm centres
For deep beams clad with thicker boards for greater fire resistance, it is advisable to fix the soldiers at nominal 600mm centres in order to reduce the load on the soldiers. For steel beams greater than 600mm deep, a T-section soldier should be used to provide a stronger support
- ③ Continuous galvanised steel channel 19mm x 38mm x 19mm x 1.6mm thick or similar located at the bottom flange, leg of each channel is facing inner surface of the flange
- ④a Continuous galvanised steel angles minimum 32mm x 19mm x 0.9mm thick or similar beneath the upper flange OR fixed to the floor slab using non combustible proprietary anchors at nominal 500mm centres
- ④b Continuous galvanised steel Z-section fixed to the bottom flange using non combustible proprietary anchors at nominal 200mm centres AND on the PROMATECT®-H soldier/soffit board without mechanical fixing for differential movement allowance. Caulk all edges between the board and the substrate with PROMASEAL® AN Acrylic Sealant
- ⑤ Vertical and horizontal joints in adjacent board sides to be staggered at minimum 300mm
- ⑥a Self-drilling or self-tapping drywall screws fixed to channel/angle at nominal 200mm centres. Screw length should be additional 20mm of the board thickness
- ⑥b Self-drilling or self-tapping drywall screws fixed to soldiers at nominal 100mm centres. Screw length should be additional 20mm of the board thickness
- ⑦ Structural steel beam
- ⑧ Floor slab
- ⑨ Caulk all edges between the board and the floor slab with PROMASEAL® AN Acrylic Sealant, depth in accordance with the required board thickness

The following is a standard Architectural Specification for structural steel column and beam protection using PROMATECT®-H. Please note that PROMATECT®-H can be installed by being fixed to a steel frame or, for board thicknesses > 25mm, being fixed with the board face to the board edge. The end user must determine the suitability of any particular design to meet the performance requirements of any application before undertaking any work. If in doubt, please first obtain the advice from a suitably qualified engineer.

The installation methods described herein are suitable for steel sections up to 686mm deep and 325mm wide. For larger section or when protecting multiple sections within a single encasement, please consult Promat.

Where a column box encasement abuts a beam protected with a profiled fire protection system, e.g. intumescent paint, the column webs should be sealed at their tops using PROMATECT®-H.

Fire Exposure & Area of Application

Exposed faces of steelwork internal to building, for up to 180 minute fire resistance in accordance with the requirements of BS 476: Part 21: 1987, AS 1530: Part 4: 2005 or ASTM E119: 2007.⁽¹⁾

Location

⁽²⁾

Type of Construction

_____ minute⁽³⁾ fire resistance to PROMATECT®-H one sided, two sided, three sided or four sided encasement of structural steel columns and beams.

Lining Boards

_____ ⁽⁴⁾ thick PROMATECT®-H matrix engineered mineral boards as manufactured by Promat International (Asia Pacific) Ltd, in size _____ mm x _____ mm⁽⁵⁾, cut to size on-site/pre cut in accordance with the schedule of sizes⁽⁶⁾ and fixed in accordance with the manufacturer's recommended details and fixing instructions.

Fixing To Steel Frame

COLUMNS

PROMATECT®-H boards to be fixed to 19mm x 38mm x 19mm x 1.6mm continuous pressed steel channels or similar using _____ mm^(7a) self-tapping screws at nominal 200mm centres.

BEAMS

PROMATECT®-H boards to be fixed using _____ mm^(7a) self-tapping screws at nominal 200mm centres to nominal 19mm x 38mm x 19mm x 1.6mm continuous pressed steel channels or similar at bottom steel flange AND to 32mm x 19mm x 0.9mm continuous pressed steel angles secured to soffit of floor/roof slab or top steel flange. The angles should be fixed at nominal 500mm centres.

Fixing Board Face To Board Edge

COLUMNS

PROMATECT®-H boards to be fixed by board face to board edge using _____ mm^(7b) deep threaded screws at nominal 200mm centres. Allow minimum 25mm penetration.

BEAMS

PROMATECT®-H side boards to be fixed to 100mm x 25mm thick PROMATECT®-H soldiers wedged between flanges at nominal 1220mm centres using _____ mm^(7b) deep threaded screws at nominal 100mm centres.

PROMATECT®-H side boards to be fixed to PROMATECT®-H soffit boards using _____ mm^(7b) deep threaded screws at 200mm centres.

Continued on next page

Continued from previous page

Butt Jointing For Fixing To Steel Frame

For beam casings only, PROMATECT®-H board joints in the soffit to be backed with 100mm wide x minimum _____mm⁽⁴⁾ thick PROMATECT®-H internal cover strips secured with _____mm⁽⁶⁾ self-drilling, self-tapping screws at nominal 100mm centres.

Butt Jointing For Fixing Board Face To Board Edge

For beam casings only, PROMATECT®-H board joints in the soffit to be backed with 100mm wide x minimum _____mm⁽⁴⁾ thick PROMATECT®-H internal cover strips secured with _____mm⁽⁶⁾ deep threaded screws to one side of board joint only.

Follow-on Trades

Surface of boards to be prepared for painting/plastering/tiling⁽⁹⁾ in accordance with manufacturer's recommendations.

NOTE:

- ⁽¹⁾, ⁽⁶⁾, ⁽⁹⁾ delete as appropriate.
- ⁽²⁾ insert location, e.g. "beams and columns to offices interior", or provide steelwork drawing reference.
- ⁽³⁾ insert required fire resistance level (not exceeding 120 minutes for BS or AS and not exceeding 180 minutes for ASTM).
- ⁽⁴⁾ insert required thickness by reference to section factor (Hp/A) and fire resistance level.
- ⁽⁵⁾ select board size on basis of economy in cutting. Standard board size is 2440mm x 1220mm.
- ^(7a) insert screw length which is minimum 20mm longer than the encasement thickness.
- ^(7b) insert screw length which gives minimum 25mm penetration having regard to encasement thickness.
- ⁽⁸⁾ insert screw length which is minimum 5mm longer than twice the encasement thickness.

Hp/A Ratio Table 1 Up to 120/-/- fire resistance in accordance with the requirements of **BS 476: Part 21: 1987 and AS 1530: Part 4: 2005** (reports no. BRE CC 84889A and BRE CC 84975) for **structural steel column and beam protection at critical temperature of 550°C**

Fire resistance	PROMATECT®-H board thickness (mm)																			
	6	9	12	15	18	20	21	24	25	26	27	29	30	31	32	33	34	35	36	37
30 minutes	260	260	260	260	260	260	260	260	260	260	260	260	260	260	260	260	260	260	260	260
60 minutes	47	88	156	260	260	260	260	260	260	260	260	260	260	260	260	260	260	260	260	260
90 minutes	—	37	56	79	110	136	151	212	238	260	260	260	260	260	260	260	260	260	260	260
120 minutes	—	—	34	46	59	70	76	95	103	111	119	139	150	161	174	188	204	221	241	260

Hp/A Ratio Table 2 Up to 180/-/- fire resistance in accordance with the requirements of **ASTM E119: 2007** (report no. iBMB 851106) for **structural steel column and beam protection at critical temperature of 550°C**

Fire resistance	PROMATECT®-H board thickness (mm)								
	8	10	12	15	20	25	30	35	40
30 minutes	300	300	300	300	300	300	300	300	300
60 minutes	89	139	179	239	300	300	300	300	300
90 minutes	60	79	89	139	239	300	300	300	300
120 minutes	—	—	60	79	139	219	300	300	300
180 minutes	—	—	—	—	60	79	119	159	300

The thicknesses in above tables can be made up from a single layer or no more than two layers of PROMATECT®-H board. For two layer application, secure the thinner layer first and stagger all joints between layers at minimum 300mm centres. For four sided encasement of column, install the second layer separately from the first layer and no gap is required between layers. For encasements of beam, screw the second layer to the first layer.

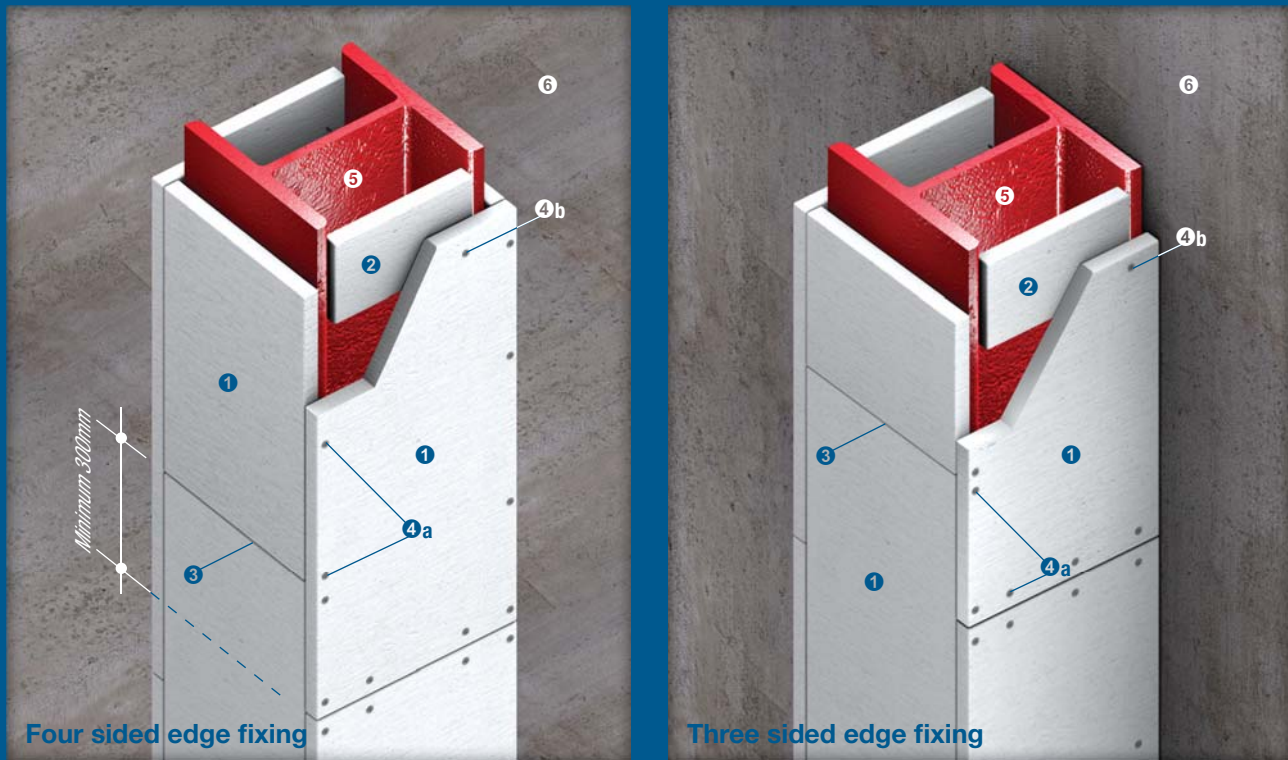

Up to 240/-/- fire resistance in accordance with the requirements of BS 476: Part 21: 1987 and AS 1530: Part 4: 2005, and up to 180/-/- fire resistance in accordance with the requirements of ASTM E119: 2007

- ❶ PROMATECT®-L board, thickness in accordance with the Hp/A Ratio tables on page 31
- ❷ PROMATECT®-L soldiers 100mm wide, minimum thickness similar to the board thickness of ❶, fixed within the web of the steel column at maximum 1220mm centres behind the board joints using screws at 100mm centres or staples at 50mm centres
- ❸ Horizontal joints in adjacent board sides to be staggered at minimum 300mm
For wide columns, it is advisable to include a PROMATECT®-L cover strip behind the joints within the web of the steel column to provide additional impact resistance
- ❹a Fixings in accordance with table below. Care should be taken not to overtighten the screws. When edge fixing it is advisable to drill pilot holes, particularly with 20mm thick boards

PROMATECT®-L board thickness	Deep threaded drywall screws preferably with ribbed heads at 200mm centres	Steel wire staples at 100mm centres
20mm	No. 6 x 38mm	50/11/1.5mm
25mm	No. 6 x 50mm	63/11/1.5mm
30mm	No. 8 x 63mm	63/11/1.5mm
35mm	No. 8 x 63mm	70/12/2mm
40mm	No. 8 x 75mm	70/12/2mm
50mm	No. 10 x 100mm	90/12/2mm
60mm	No. 10 x 100mm	90/12/2mm

Please consult Promat for further guidance on steel wire staple fixing

- ❹b Self-drilling or self-tapping drywall screws fixed to soldiers at nominal 100mm centres. Screw length should be additional 20mm of the board thickness
- ❺ Structural steel column
- ❻ Concrete wall substrate

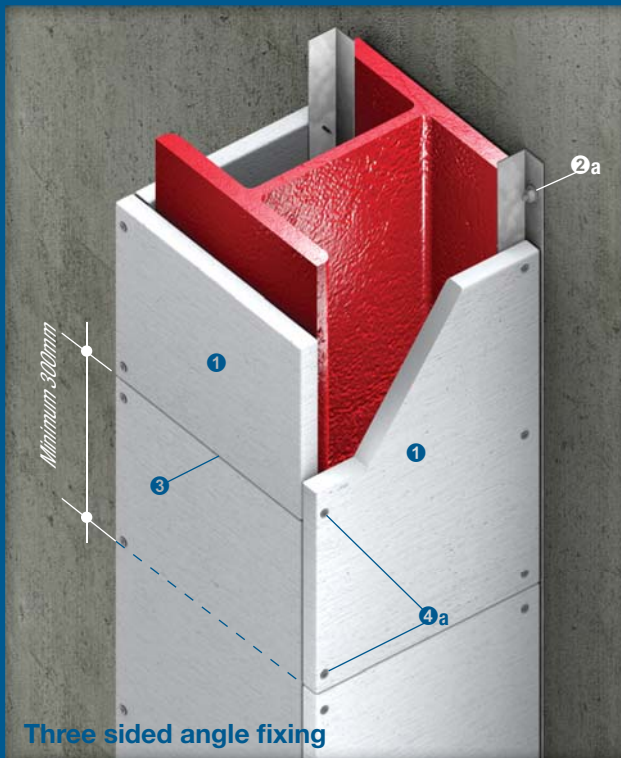

Three sided angle fixing

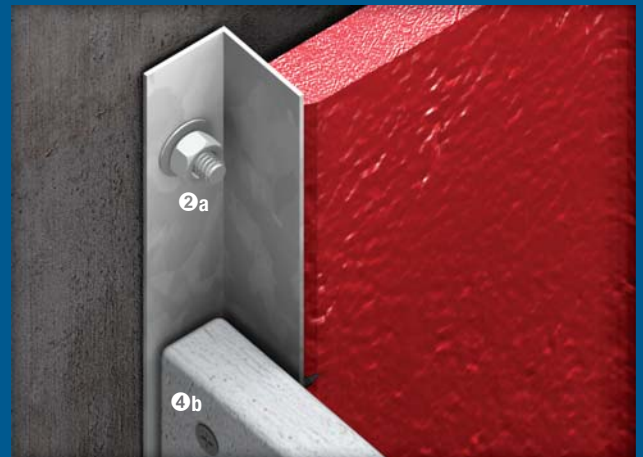

Option

Up to 240/- fire resistance in accordance with the requirements of BS 476: Part 21: 1987 and AS 1530: Part 4: 2005, and up to 180/- fire resistance in accordance with the requirements of ASTM E119: 2007

- ❶ PROMATECT®-L board, thickness in accordance with the Hp/A Ratio tables on page 31
- ❷a Continuous galvanised steel angles minimum 32mm x 19mm x 0.9mm thick or similar fixed to the wall using non combustible proprietary anchors at nominal 500mm centres
- ❷b Continuous galvanised steel angles minimum 32mm x 19mm x 0.9mm thick or similar fixed to the flange using Tek screws, shot fired nails or welding. Secure edges of side boards at 200mm centres
- ❸ Horizontal joints in adjacent board sides to be staggered at minimum 300mm
For wide columns, it is advisable to include a PROMATECT®-L cover strip behind the joints within the web of the steel column to provide additional impact resistance
- ❹a Fixings in accordance with table below. Care should be taken not to overtighten the screws. When edge fixing it is advisable to drill pilot holes, particularly with 20mm thick boards

PROMATECT®-L board thickness	Deep threaded drywall screws preferably with ribbed heads at 200mm centres	Steel wire staples at 100mm centres
20mm	No. 6 x 38mm	50/11/1.5mm
25mm	No. 6 x 50mm	63/11/1.5mm
30mm	No. 8 x 63mm	63/11/1.5mm
35mm	No. 8 x 63mm	70/12/2mm
40mm	No. 8 x 75mm	70/12/2mm
50mm	No. 10 x 100mm	90/12/2mm
60mm	No. 10 x 100mm	90/12/2mm

Please consult Promat for further guidance on steel wire staple fixing

- ❹b Self-drilling or self-tapping drywall screws fixed to channel/angle at nominal 200mm centres. Screw length should be additional 20mm of the board thickness
- ❺ Structural steel column
- ❻ Concrete wall substrate

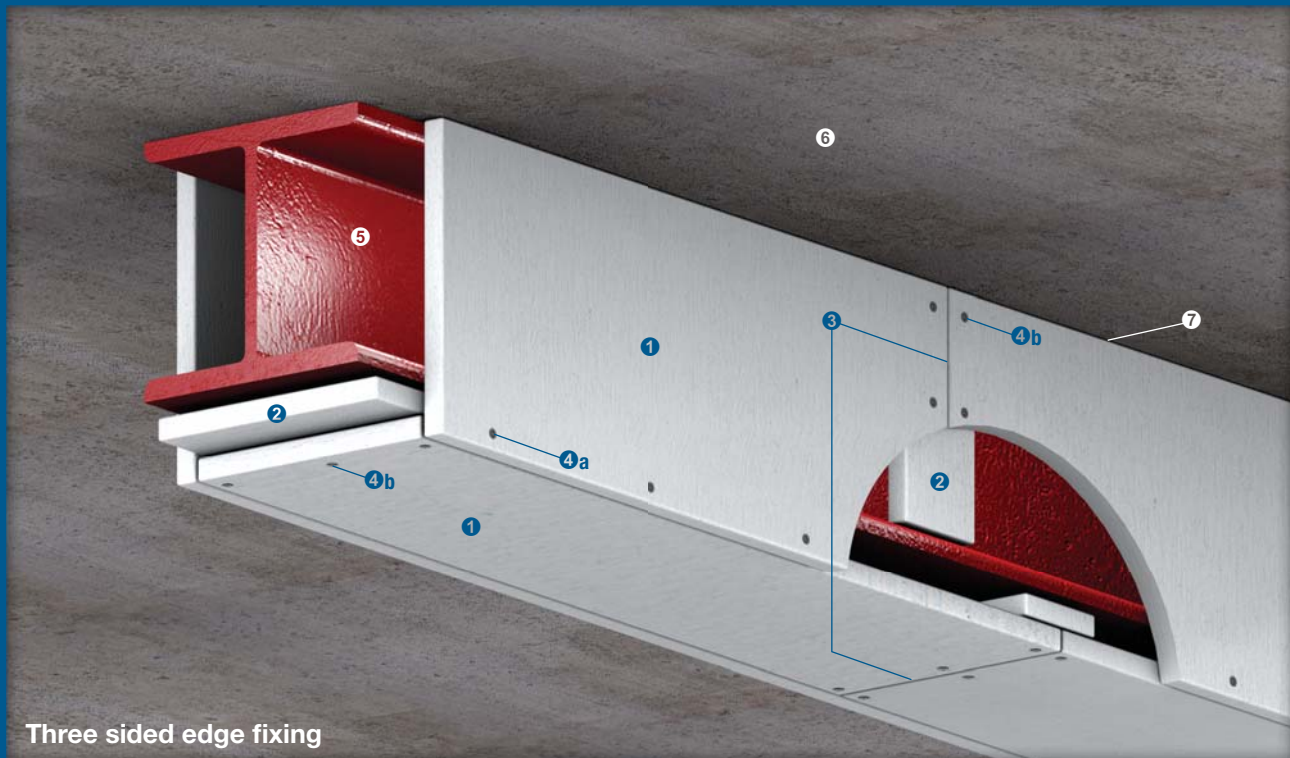

Three sided edge fixing

Up to 240/-/- fire resistance in accordance with the requirements of BS 476: Part 21: 1987 and AS 1530: Part 4: 2005, and up to 180/-/- fire resistance in accordance with the requirements of ASTM E119: 2007

- ❶ PROMATECT®-L board, thickness in accordance with the Hp/A Ratio tables on page 31
- ❷ PROMATECT®-L soldiers 100mm wide, minimum thickness similar to the board thickness of ❶, fixed within the web of the steel beam at maximum 1220mm centres behind the board joints using screws at 100mm centres or staples at 50mm centres
For deep beams clad with thicker boards for greater fire resistance, it is advisable to fix the soldiers at nominal 600mm centres in order to reduce the load on the soldiers. For steel beams greater than 600mm deep, a T-section soldier should be used to provide a stronger support
- ❸ Vertical and horizontal joints in adjacent board sides to be staggered at minimum 300mm
- ❹a Fixings in accordance with table below. Care should be taken not to overtighten the screws. When edge fixing it is advisable to drill pilot holes, particularly with 25mm thick boards

PROMATECT®-L board thickness	Deep threaded drywall screws preferably with ribbed heads at 200mm centres	Steel wire staples at 100mm centres
20mm	No. 6 x 38mm	50/11/1.5mm
25mm	No. 6 x 50mm	63/11/1.5mm
30mm	No. 8 x 63mm	63/11/1.5mm
35mm	No. 8 x 63mm	70/12/2mm
40mm	No. 8 x 75mm	70/12/2mm
50mm	No. 10 x 100mm	90/12/2mm
60mm	No. 10 x 100mm	90/12/2mm

Please consult Promat for further guidance on steel wire staple fixing

- ❹b Self-drilling or self-tapping drywall screws fixed to channel/angle at nominal 200mm centres and to soldiers at nominal 100mm centres. Screw length should be additional 20mm of the board thickness
- ❺ Structural steel beam
- ❻ Floor slab
- ❼ Caulk all edges between the board and the floor slab with PROMASEAL® AN Acrylic Sealant, depth in accordance with the required board thickness

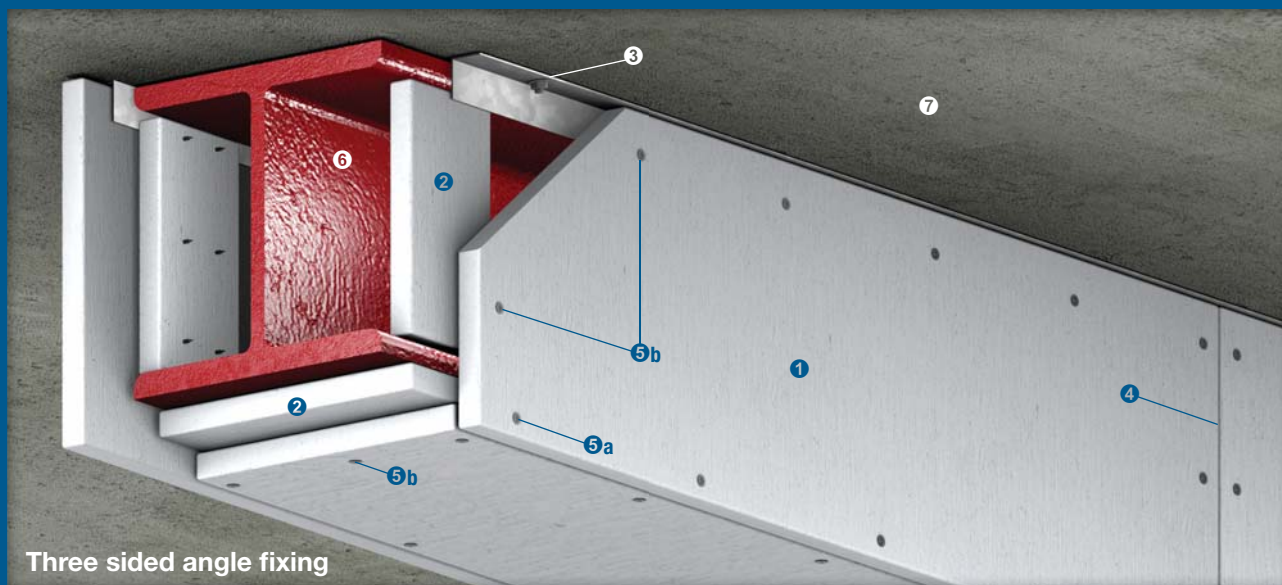

Three sided angle fixing

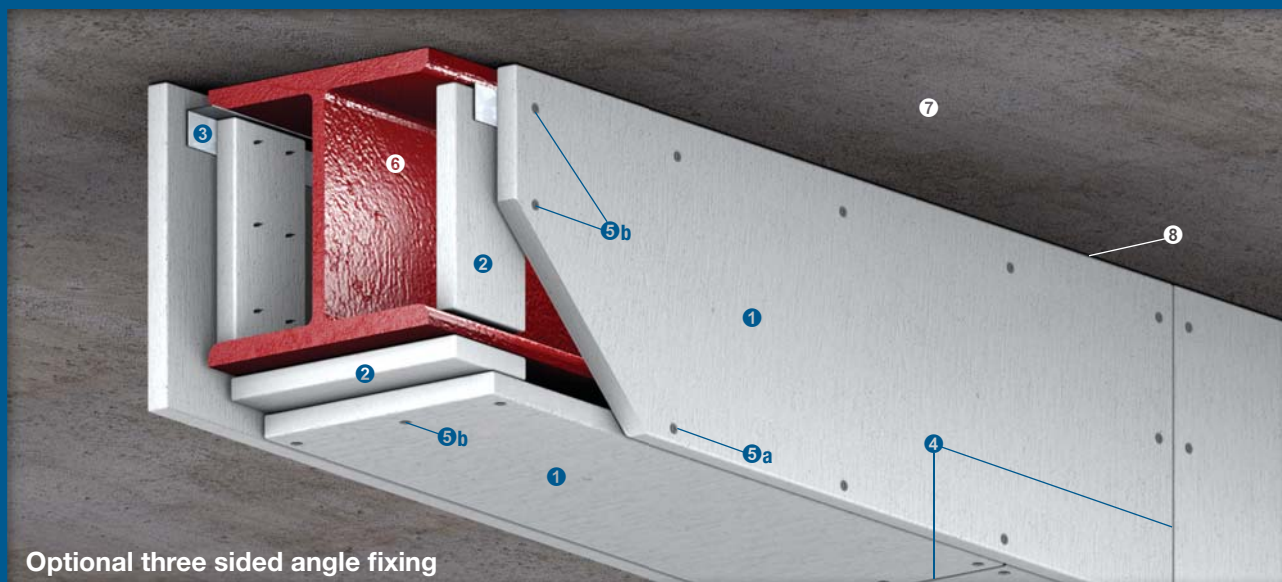

Optional three sided angle fixing

Up to 240/-/- fire resistance in accordance with the requirements of BS 476: Part 21: 1987 and AS 1530: Part 4: 2005, and up to 180/-/- fire resistance in accordance with the requirements of ASTM E119: 2007

- ❶ PROMATECT®-L board, thickness in accordance with the Hp/A Ratio tables on page 31
- ❷ PROMATECT®-L soldiers 100mm wide, minimum thickness similar to the board thickness of ❶, fixed within the web of the steel beam at maximum 1220mm centres behind the board joints using screws at 100mm centres or staples at 50mm centres
For deep beams clad with thicker boards for greater fire resistance, it is advisable to fix the soldiers at nominal 600mm centres in order to reduce the load on the soldiers. For steel beams greater than 600mm deep, a T-section soldier should be used to provide a stronger support
- ❸ Continuous galvanised steel angles minimum 32mm x 19mm x 0.9mm thick or similar beneath the upper flange OR fixed to the floor slab using non combustible proprietary anchors at nominal 500mm centres
- ❹ Vertical and horizontal joints in adjacent board sides to be staggered at minimum 300mm

- ❺a Fixings in accordance with the table on page 28. Care should be taken not to overtighten the screws. When edge fixing it is advisable to drill pilot holes, particularly with 25mm thick boards
- ❺b Self-drilling or self-tapping drywall screws fixed to channel/angle at nominal 200mm centres and to soldiers at nominal 100mm centres. Screw length should be additional 20mm of the board thickness
- ❻ Structural steel beam
- ❼ Floor slab
- ❽ Caulk all edges between the board and the floor slab with PROMASEAL® AN Acrylic Sealant, depth in accordance with the required board thickness

The following is a standard Architectural Specification for structural steel column and beam protection using PROMATECT®-L. Please note that PROMATECT®-L can be installed by using either screw or staple type of edge fixing. The end user must determine the suitability of any particular design to meet the performance requirements of any application before undertaking any work. If in doubt, please first obtain the advice from a suitably qualified engineer.

The installation methods described herein are suitable for steel sections up to 686mm deep and 325mm wide. For larger section or when protecting multiple sections within a single encasement, please consult Promat.

Where a column box encasement abuts a beam protected with a profiled fire protection system, e.g. intumescent paint, the column webs should be sealed at their tops using PROMATECT®-L.

Fire Exposure & Area of Application

Exposed faces of steelwork internal to building, for up to 240 minute fire resistance in accordance with the requirements of BS 476: Part 21: 1987, AS 1530: Part 4: 2005 or ASTM E119: 2007.⁽¹⁾

Location

⁽²⁾

Type of Construction

_____ minute⁽³⁾ fire resistance to PROMATECT®-L one sided, two sided, three sided or four sided encasement of structural steel columns and beams.

Lining Boards

_____mm⁽⁴⁾ thick PROMATECT®-L matrix engineered mineral boards as manufactured by Promat International (Asia Pacific) Ltd, in size _____mm x _____mm⁽⁵⁾, cut to size on-site/pre cut in accordance with the schedule of sizes⁽⁶⁾ and fixed in accordance with the manufacturer's recommended details and fixing instructions.

Screw Fixing

COLUMNS

PROMATECT®-L boards to be fixed by board face-to-board edge using _____mm^(7a) self-drilling, self-tapping screws at nominal 200mm centres.

BEAMS

Vertical PROMATECT®-L boards to be screwed to 100mm wide x _____mm⁽⁴⁾ thick PROMATECT®-L soldiers wedged between flanges at 600~1200mm centres using _____mm^(7a) self-drilling, self-tapping screws at nominal 100mm centres.

Where mechanical fixing is required for columns or beams, PROMATECT®-L boards to be fixed by board face-to-board edge using _____mm^(7a) self-drilling, self-tapping screws at nominal 200mm centres to 32mm x 19mm x 0.9mm continuous pressed steel angles secured to soffit of floor/roof slab or top steel flange. The angles should be fixed at nominal 500mm centres.

Staple Fixing

COLUMNS

PROMATECT®-L boards to be fixed by board face to board edge using _____mm^(7b) staples at nominal 100mm centres.

BEAMS

Vertical PROMATECT®-L boards to be screwed to 100mm wide x _____mm⁽⁴⁾ thick PROMATECT®-L soldiers wedged between flanges at 600~1200mm centres using _____mm^(7b) staples at nominal 50mm centres.

Where mechanical fixing is required for columns or beams, PROMATECT®-L boards to be fixed by board face to board edge using _____mm^(7b) staples at nominal 100mm centres to 32mm x 19mm x 0.9mm continuous pressed steel angles secured to soffit of floor/roof slab or top steel flange. The angles should be fixed at nominal 500mm centres.

Continued on next page

Continued from previous page

Butt Jointing For Screw Fixing

For beam casings only, PROMATECT®-L board joints in the soffit to be backed with 100mm wide x minimum _____mm⁽⁴⁾ thick PROMATECT®-L internal cover strips secured with _____mm⁽⁵⁾ self-drilling, self-tapping screws at nominal 100mm centres.

Butt Jointing For Staple Fixing

For beam casings only, PROMATECT®-L board joints in the soffit to be backed with 100mm wide x minimum _____mm⁽⁴⁾ thick PROMATECT®-L internal cover strips secured with _____mm⁽⁶⁾ staples to one side of board joint only.

Follow-on Trades

Surface of boards to be prepared for painting/plastering/tiling⁽⁹⁾ in accordance with manufacturer's recommendations.

NOTE:

- ⁽¹⁾, ⁽⁶⁾, ⁽⁹⁾ delete as appropriate.
- ⁽²⁾ insert location, e.g. "beams and columns to offices interior", or provide steelwork drawing reference.
- ⁽³⁾ insert required fire resistance level (not exceeding 240 minutes for BS or AS and not exceeding 180 minutes for ASTM).
- ⁽⁴⁾ insert required thickness by reference to section factor (Hp/A) and fire resistance level.
- ⁽⁵⁾ select board size on basis of economy in cutting. Standard board size is 2500mm x 1200mm.
- ^(7a) insert screw length which gives minimum 25mm penetration having regard to encasement thickness.
- ^(7b) insert staple length which gives minimum 25mm penetration having regard to encasement thickness.
- ⁽⁸⁾ insert screw length which is minimum 5mm longer than twice the encasement thickness.

Hp/A Ratio Table 1 Up to 240/-/- fire resistance in accordance with the requirements of **BS 476: Part 21: 1987** and **AS 1530: Part 4: 2005** (reports no. BRE CC 84976 and BRE CC 84889B) for **structural steel column and beam protection at critical temperature of 550°C**

Fire resistance	PROMATECT®-L board thickness (mm)									
	20	25	30	35	40	45	50	55	60	65
30 minutes	260	260	260	260	260	260	260	260	260	260
60 minutes	260	260	260	260	260	260	260	260	260	260
90 minutes	157	260	260	260	260	260	260	260	260	260
120 minutes	—	127	216	260	260	260	260	260	260	260
180 minutes	—	—	76	104	143	205	260	260	260	260
240 minutes	—	—	—	59	74	94	119	153	199	260

Hp/A Ratio Table 2 Up to 180/-/- fire resistance in accordance with the requirements of **ASTM E119: 2007** (report no. iBMB 851106) for **structural steel column and beam protection at critical temperature of 550°C**

Fire resistance	PROMATECT®-L board thickness (mm)				
	20	25	30	35	40
30 minutes	300	300	300	300	300
60 minutes	300	300	300	300	300
90 minutes	219	300	300	300	300
120 minutes	139	159	239	270	300
180 minutes	79	99	109	119	300

The thicknesses in above tables can be made up from a single layer or no more than two layers of PROMATECT®-L board. For two layer application, secure the thinner layer first and stagger all joints between layers at minimum 300mm centres. For four sided encasement of column, install the second layer separately from the first layer and no gap is required between layers. For encasements of beam, screw the second layer to the first layer.

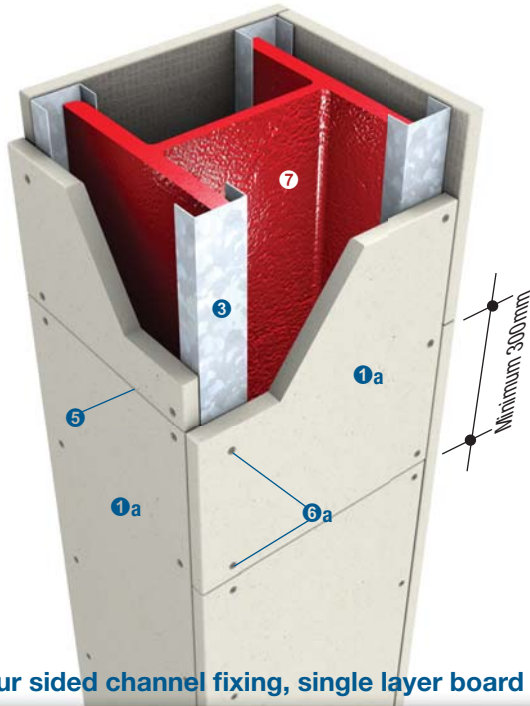

Four sided channel fixing, single layer board

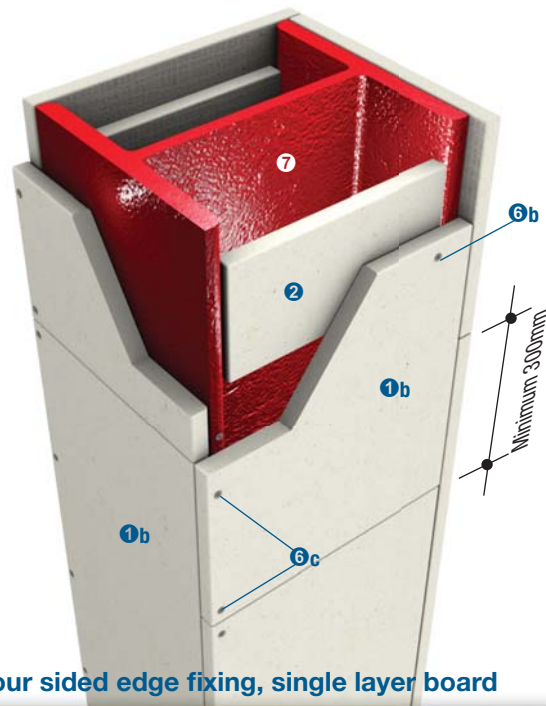

Four sided edge fixing, single layer board

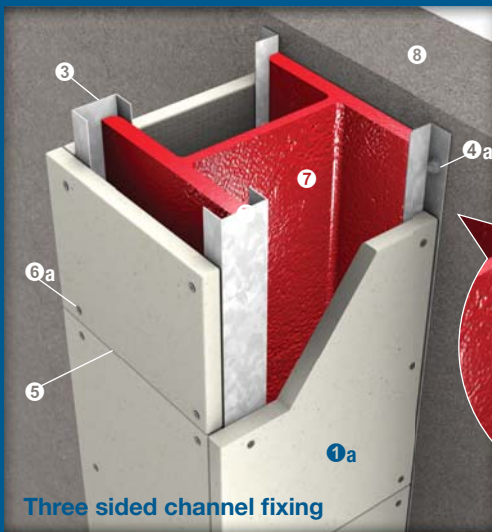

Three sided channel fixing

Up to 240/- fire resistance in accordance with the requirements of BS 476: Part 21: 1987 and AS 1530: Part 4: 2005

①a PROMATECT® 50 board, ≤15mm of thickness in accordance with the Hp/A Ratio table 1 on page 38, table 2 on page 39 or tables 5 and 6 on page 40

①b PROMATECT® 50 board, >15mm of thickness in accordance with the Hp/A Ratio table 1 on page 38, table 2 on page 39 or tables 5 and 6 on page 40

② PROMATECT® 50 soldiers 100mm wide, minimum thickness similar to the board thickness of ①b

③ Continuous galvanised steel channel 19mm x 38mm x 19mm x 1.6mm thick or similar, leg of each channel is located against inner surface of flange

④a Continuous galvanised steel angles minimum 32mm x 19mm x 0.9mm thick or similar fixed to the wall using non combustible proprietary anchors at nominal 500mm centres

④b Continuous galvanised steel angles minimum 32mm x 19mm x 0.9mm thick or similar fixed to the flange using Teks screws, shot fired nails or welding. Secure edges of side boards at 200mm centres

⑤ Horizontal joints in adjacent board sides to be staggered at minimum 300mm

For wide columns, it is advisable to include a PROMATECT® 50 cover strip behind the joints within the web of the steel column to provide additional impact resistance

⑥a Self-drilling or self-tapping drywall screws fixed to channel/angle at nominal 200mm centres. Screw length should be additional 20mm of the board thickness

⑥b Self-drilling or self-tapping drywall screws fixed to soldiers at nominal 100mm centres. Screw length should be additional 20mm of the board thickness

⑥c Minimum No. 6 deep threaded drywall screws, preferably with ribbed heads, fixed at 200mm centres. Incremental screw length in accordance with board thickness. Care should be taken not to overtighten the screws. When edge fixing it is advisable to drill pilot holes, particularly with 15mm thick boards

NOTE: <15mm thick boards cannot be edge fixed

⑦ Structural steel column

⑧ Concrete wall substrate

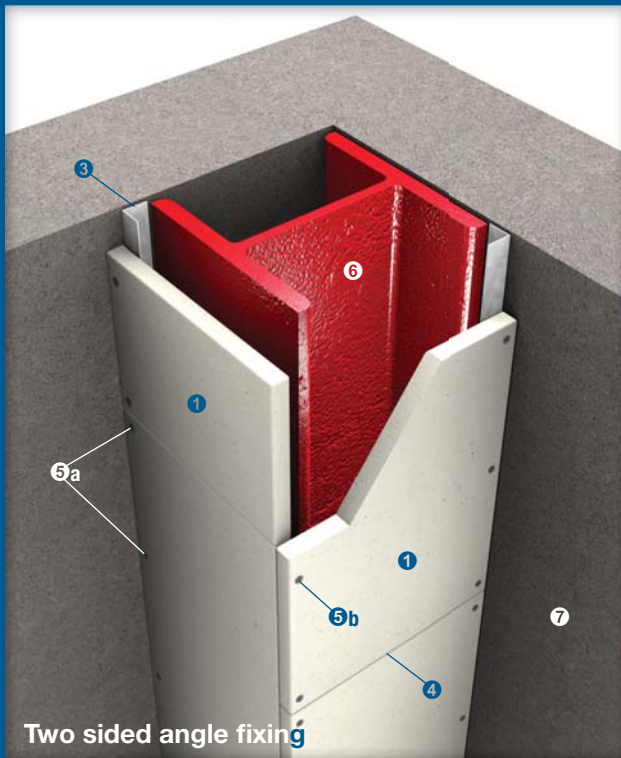

Two sided angle fixing

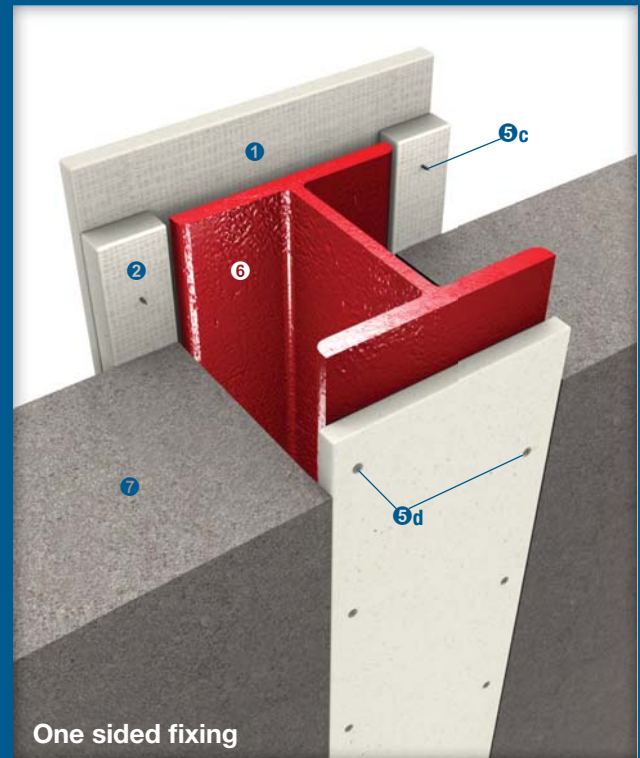

One sided fixing

Up to 240/- fire resistance in accordance with the requirements of BS 476: Part 21: 1987 and AS 1530: Part 4: 2005

- ❶ PROMATECT® 50 board, ≤15mm of thickness in accordance with the Hp/A Ratio table 1 on page 38, table 2 on page 39 or tables 5 and 6 on page 40
- ❷ PROMATECT® 50 spacer strips minimum 50mm x 25mm thick, fixed to substrate using non combustible proprietary anchors at 500mm centres with minimum 50mm overlap to either side of steel section
- ❸ Continuous galvanised steel angles minimum 32mm x 19mm x 0.9mm thick or similar fixed to the wall using non combustible proprietary anchors at nominal 500mm centres
- ❹ Horizontal joints in adjacent board sides to be staggered at minimum 300mm
For wide columns, it is advisable to include a PROMATECT® 50 cover strip behind the joints within the web of the steel column to provide additional impact resistance
- ❺a Self-drilling or self-tapping drywall screws fixed to channel/angle at nominal 200mm centres. Screw length should be additional 20mm of the board thickness
- ❺b Minimum No. 6 deep threaded drywall screws, preferably with ribbed heads, fixed at 200mm centres. Incremental screw length in accordance with board thickness. Care should be taken not to overtighten the screws. When edge fixing it is advisable to drill pilot holes, particularly with 15mm thick boards
NOTE: <15mm thick boards cannot be edge fixed
- ❺c Self-drilling or self-tapping screws at 200mm centres or steel wire staples at 100mm centres, fixed the main PROMATECT® 50 board onto the spacer strips
- ❺d Two rows of self-drilling, self-tapping Teks screws fixed to steel column at nominal 300mm staggered centres
- ❻ Structural steel column
- ❼ Concrete wall substrate

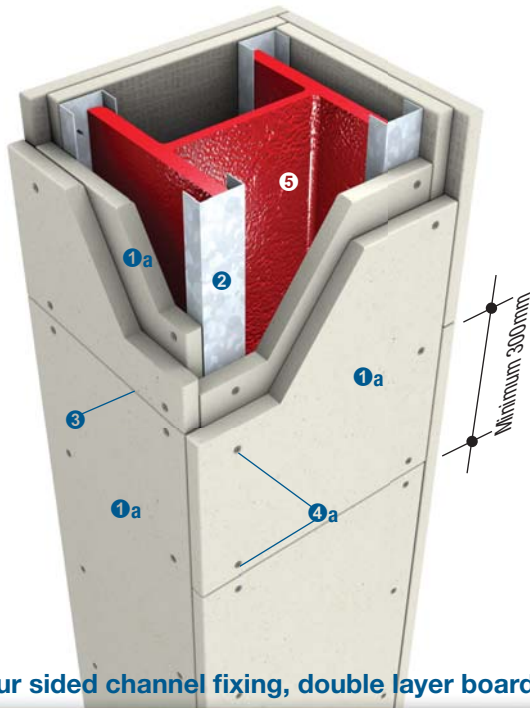

Four sided channel fixing, double layer board

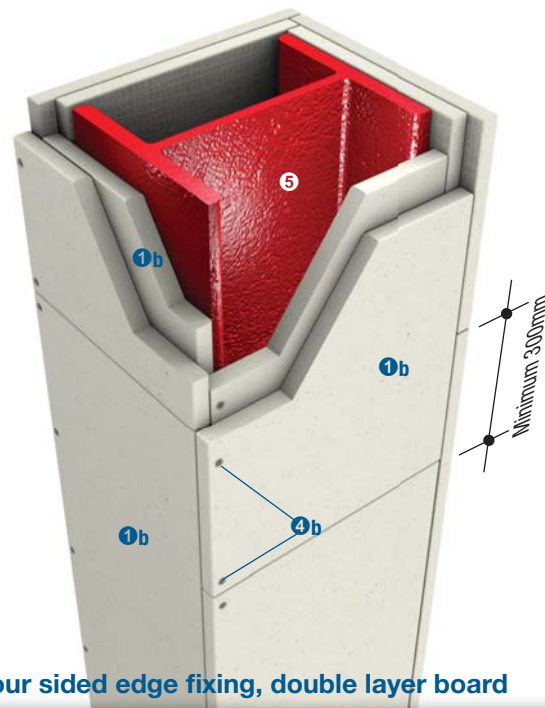

Four sided edge fixing, double layer board

Up to 240/-/- fire resistance in accordance with the requirements of BS 476: Part 21: 1987 and AS 1530: Part 4: 2005

- ❶ a PROMATECT® 50 board, $\leq 15\text{mm}$ of thickness in accordance with the Hp/A Ratio table 1 on page 38, table 2 on page 39 or tables 5 and 6 on page 40
 - ❶ b PROMATECT® 50 board, $> 15\text{mm}$ of thickness in accordance with the Hp/A Ratio table 1 on page 38, table 2 on page 39 or tables 5 and 6 on page 40
 - ❷ Continuous galvanised steel channel $19\text{mm} \times 38\text{mm} \times 19\text{mm} \times 1.6\text{mm}$ thick or similar, leg of each channel is located against inner surface of flange
 - ❸ Horizontal joints in adjacent board sides to be staggered at minimum 300mm
 - ❹ a Self-drilling or self-tapping drywall screws fixed to channel/angle at nominal 200mm centres. Screw length should be additional 20mm of the board thickness
 - ❹ b Minimum No. 6 deep threaded drywall screws, preferably with ribbed heads, fixed at 200mm centres. Incremental screw length in accordance with board thickness. Care should be taken not to overtighten the screws. When edge fixing it is advisable to drill pilot holes, particularly with 15mm thick boards
- NOTE: $< 15\text{mm}$ thick boards cannot be edge fixed
- ❺ Structural steel column

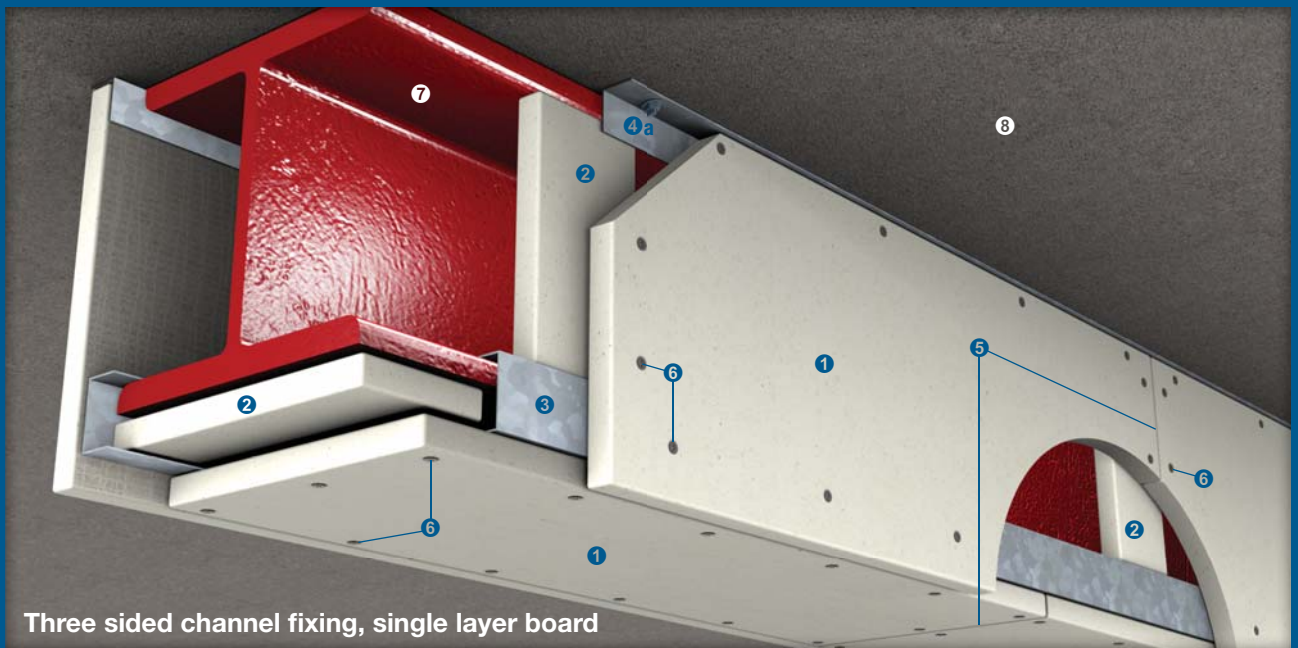

Three sided channel fixing, single layer board

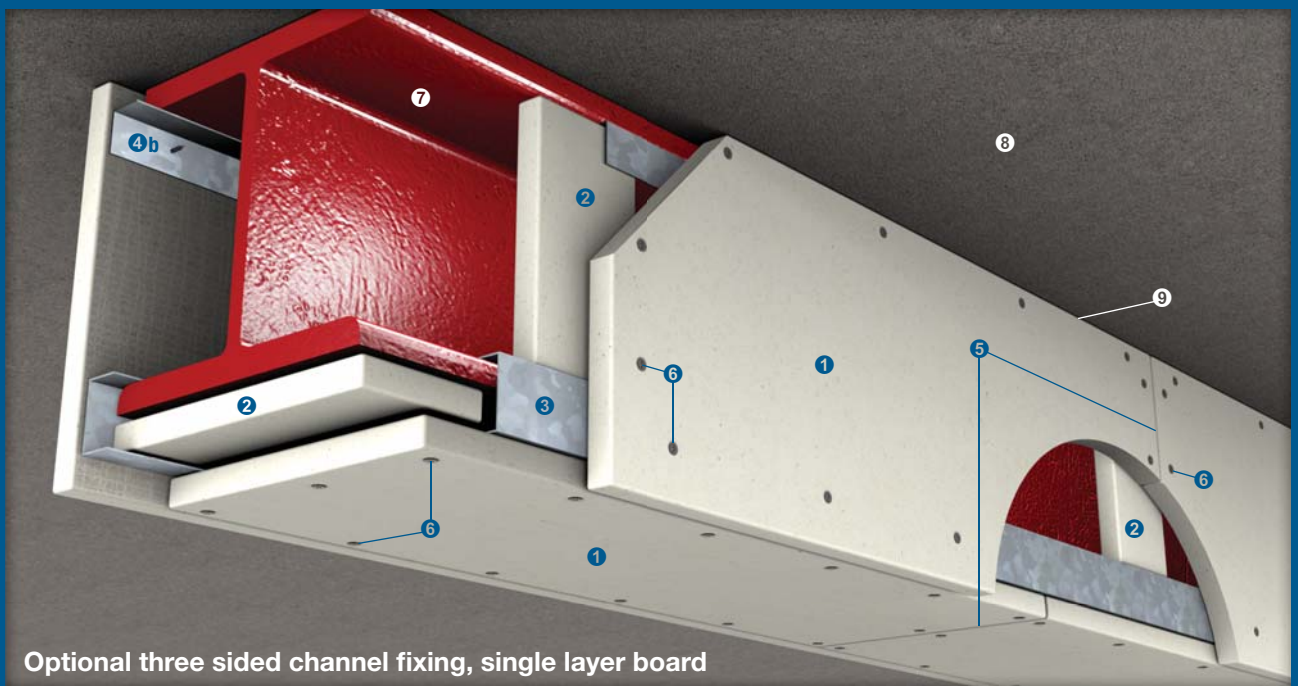

Optional three sided channel fixing, single layer board

Up to 240/-/- fire resistance in accordance with the requirements of BS 476: Part 21: 1987 and AS 1530: Part 4: 2005

- ❶ PROMATECT® 50 board, $\leq 15\text{mm}$ of thickness in accordance with the H_p/A ratio tables 3 and 4 on page 39, table 7 on page 40 or table 8 on page 41
- ❷ PROMATECT® 50 soldiers 100mm wide, minimum thickness similar to the board thickness of ❶, fixed within the web of the steel beam at maximum 1220mm centres behind the board joints using screws at 100mm centres
For deep beams clad with thicker boards for greater fire resistance, it is advisable to fix the soldiers at nominal 600mm centres in order to reduce the load on the soldiers. For steel beams greater than 600mm deep, a T-section soldier should be used to provide a stronger support
- ❸ Continuous galvanised steel channel 19mm x 38mm x 19mm x 1.6mm thick or similar located at the bottom flange, leg of each channel is facing inner surface of the flange

- ❹a Continuous galvanised steel angles minimum 32mm x 19mm x 0.9mm thick or similar fixed to the floor slab using non combustible proprietary anchors at nominal 500mm centres
- ❹b Continuous galvanised steel angles minimum 32mm x 19mm x 0.9mm thick or similar beneath the upper flange
- ❺ Vertical and horizontal joints in adjacent board sides to be staggered at minimum 300mm
- ❻ Self-drilling or self-tapping drywall screws fixed to channel/angle at nominal 200mm centres and to soldiers at nominal 100mm centres. Screw length should be additional 20mm of the board thickness
- ❼ Structural steel beam
- ❽ Floor slab
- ❾ Caulk all edges between the board and the floor slab with PROMASEAL® AN Acrylic Sealant, depth in accordance with the required board thickness

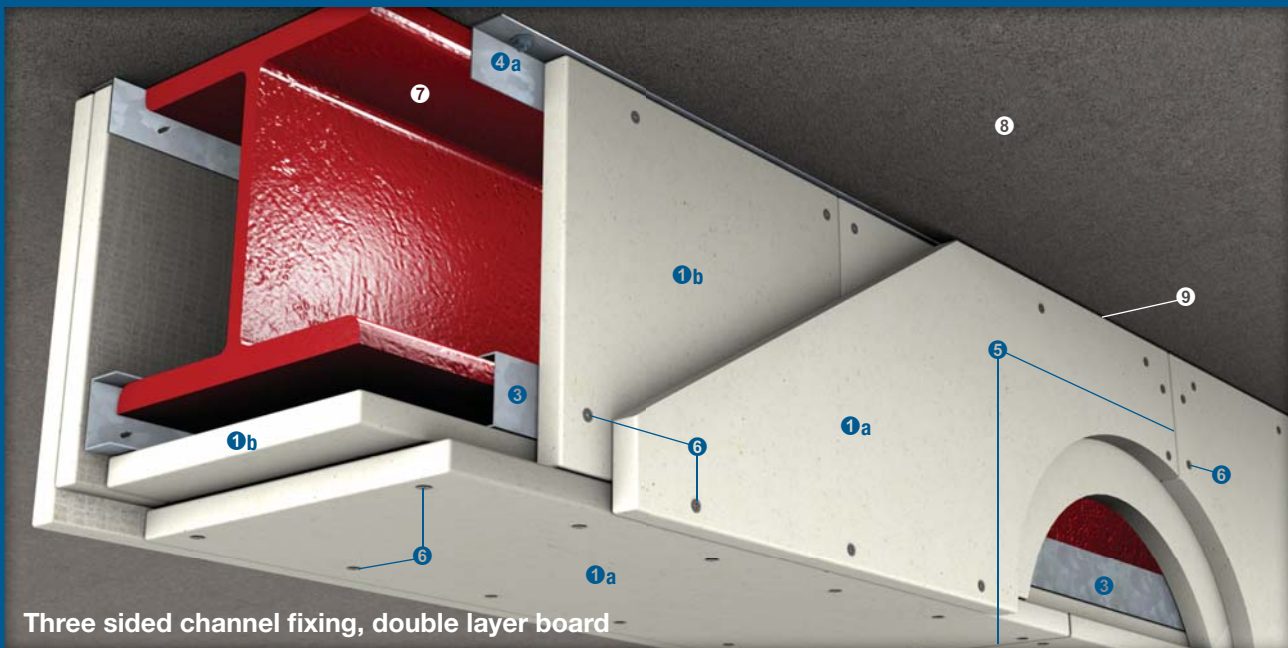

Three sided channel fixing, double layer board

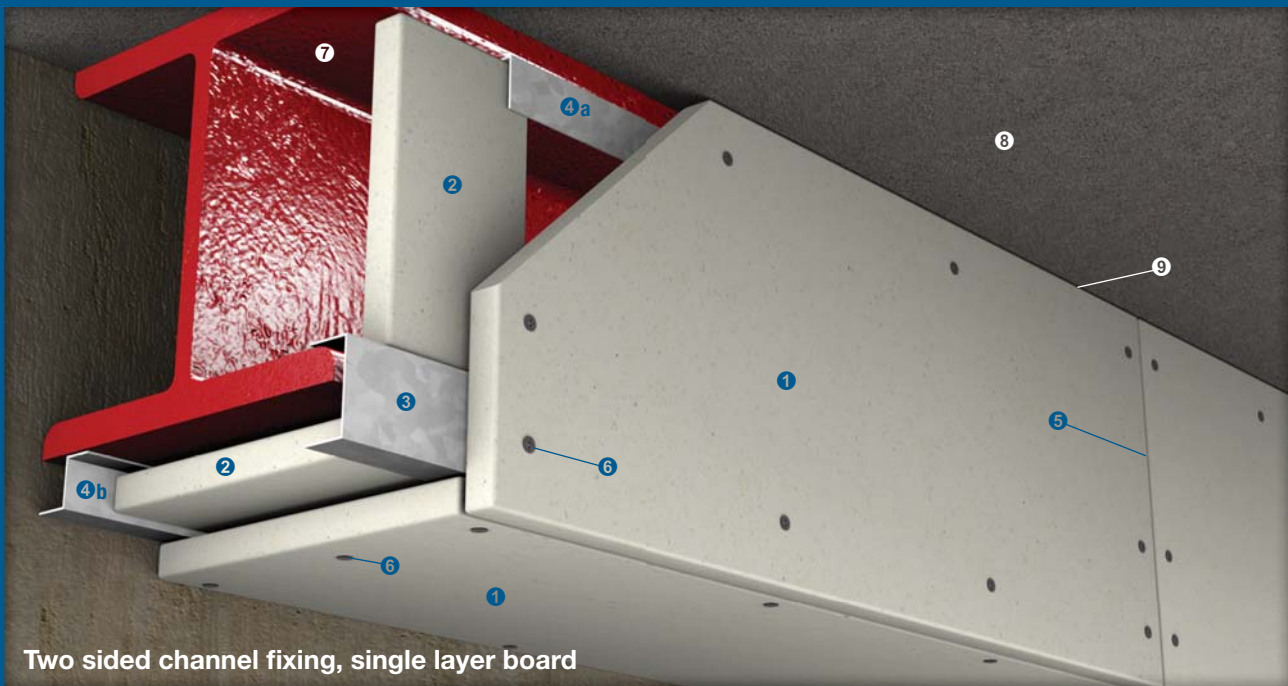

Two sided channel fixing, single layer board

Up to 240/- fire resistance in accordance with the requirements of BS 476: Part 21: 1987 and AS 1530: Part 4: 2005

- ①a PROMATECT® 50 board, ≤15mm of thickness in accordance with the Hp/A ratio tables 3 and 4 on page 39, table 7 on page 40 or table 8 on page 41
- ①b PROMATECT® 50 board, >15mm of thickness in accordance with the Hp/A ratio tables as indicated in ①a
- ② PROMATECT® 50 soldiers 100mm wide, minimum thickness similar to the board thickness of ①b, fixed within the web of the steel beam at maximum 1220mm centres behind the board joints using screws at 100mm centres
For deep beams clad with thicker boards for greater fire resistance, it is advisable to fix the soldiers at nominal 600mm centres in order to reduce the load on the soldiers. For steel beams greater than 600mm deep, a T-section soldier should be used to provide a stronger support
- ③ Continuous galvanised steel channel 19mm x 38mm x 19mm x 1.6mm thick or similar located at the bottom flange, leg of each channel is facing inner surface of the flange

- ④a Continuous galvanised steel angles minimum 32mm x 19mm x 0.9mm thick or similar fixed to the floor slab using non combustible proprietary anchors at nominal 500mm centres OR beneath the upper flange
- ④b Continuous galvanised steel Z-section fixed to the bottom flange using non combustible proprietary anchors at nominal 200mm centres AND on the PROMATECT® 50 soldier/soffit board without mechanical fixing for differential movement allowance. Caulk all edges between the board and the substrate with PROMASEAL® AN Acrylic Sealant
- ⑤ Vertical and horizontal joints in adjacent board sides to be staggered at minimum 300mm
- ⑥ Self-drilling or self-tapping drywall screws fixed to channel/angle at nominal 200mm centres and to soldiers at nominal 100mm centres. Screw length should be additional 20mm of the board thickness
- ⑦ Structural steel beam ⑧ Floor slab
- ⑨ Caulk all edges between the board and the floor slab with PROMASEAL® AN Acrylic Sealant, depth in accordance with the required board thickness

The following is a standard Architectural Specification for structural steel column and beam protection using PROMATECT® 50. Please note that PROMATECT® 50 can be installed by using either mechanical or edge fixing. The end user must determine the suitability of any particular design to meet the performance requirements of any application before undertaking any work. If in doubt, please first obtain the advice from a suitably qualified engineer.

The installation methods described herein are suitable for steel sections up to 686mm deep and 325mm wide. For larger section or when protecting multiple sections within a single encasement, please consult Promat.

Where a column box encasement abuts a beam protected with a profiled fire protection system, e.g. intumescent paint, the column webs should be sealed at their tops using PROMATECT® 50.

Fire Exposure & Area of Application

Exposed faces of steelwork internal to building, for up to 240 minute fire resistance in accordance with the requirements of BS 476: Part 21: 1987 or AS 1530: Part 4: 2005.⁽¹⁾

Location

⁽²⁾

Type of Construction

_____ minute⁽³⁾ fire resistance to PROMATECT® 50 one sided, two sided, three sided or four sided encasement of structural steel columns and beams.

Lining Boards

_____mm⁽⁴⁾ thick PROMATECT® 50 Cement Bound Matrix boards as manufactured by Promat International (Asia Pacific) Ltd, in size _____mm x _____mm⁽⁵⁾, cut to size on-site/pre cut in accordance with the schedule of sizes⁽⁶⁾ and fixed in accordance with the manufacturer's recommended details and fixing instructions.

Mechanical Fixing

COLUMNS

PROMATECT® 50 boards to be edge fixed to 19mm x 38mm x 19mm x 1.6mm continuous pressed steel channels or similar using _____mm^(7a) self-tapping screws at nominal 200mm centres.

BEAMS

PROMATECT® 50 boards to be fixed using _____mm^(7a) self-tapping screws at nominal 200mm centres to nominal 19mm x 38mm x 19mm x 1.6mm continuous pressed steel channels or similar at bottom steel flange AND to 32mm x 19mm x 0.9mm continuous pressed steel angles secured to soffit of floor/roof slab or top steel flange. The angles should be fixed at nominal 500mm centres.

Edge Fixing

COLUMNS

PROMATECT® 50 boards to be fixed by board face to board edge using _____mm^(7b) deep threaded screws at nominal 200mm centres. Allow minimum 25mm penetration.

BEAMS

PROMATECT® 50 side boards to be fixed to 100mm x _____mm⁽⁴⁾ thick PROMATECT® 50 soldiers wedged between flanges at nominal 1220mm centres using _____mm^(7b) deep threaded screws at nominal 100mm centres.

PROMATECT® 50 side boards to be fixed to PROMATECT® 50 soffit boards using _____mm^(7b) deep threaded screws at 200mm centres.

Continued on next page

Continued from previous page

Butt Jointing For Mechanical Fixing

For beam casings only, PROMATECT® 50 board joints in the soffit to be backed with 100mm wide x minimum _____mm⁽⁴⁾ thick PROMATECT® 50 internal cover strips secured with _____mm⁽⁶⁾ self-drilling, self-tapping screws at nominal 100mm centres.

Butt Jointing For Edge Fixing

For beam casings only, PROMATECT® 50 board joints in the soffit to be backed with 100mm wide x minimum _____mm⁽⁴⁾ thick PROMATECT® 50 internal cover strips secured with _____mm⁽⁶⁾ deep threaded screws to one side of board joint only.

Follow-on Trades

Surface of boards to be prepared for painting/plastering/tiling⁽⁹⁾ in accordance with manufacturer's recommendations.

NOTE:

- ⁽¹⁾, ⁽⁶⁾, ⁽⁹⁾ delete as appropriate.
- ⁽²⁾ insert location, e.g. "beams and columns to offices interior", or provide steelwork drawing reference.
- ⁽³⁾ insert required fire resistance level not exceeding 240 minutes.
- ⁽⁴⁾ insert required thickness by reference to section factor (Hp/A) and fire resistance level.
- ⁽⁵⁾ select board size on basis of economy in cutting. Standard board size is 2440mm x 1220mm.
- ^(7a) insert screw length which is minimum 20mm longer than the encasement thickness.
- ^(7b) insert screw length which gives minimum 25mm penetration having regard to encasement thickness.
- ⁽⁸⁾ insert screw length which is minimum 5mm longer than twice the encasement thickness.

Hp/A Ratio Table 1 Up to 240/-/- fire resistance in accordance with the requirements of **BS 476: Part 21: 1987** (report no. BRANZ FAR 3659) for **structural steel column protection at critical temperature of 550°C**

Fire resistance	PROMATECT® 50 board thickness (mm)												
	10	12	15	18	20	22	25	27	28	30	32	33	35
30 minutes	275	275	275	275	275	275	275	—	—	—	—	—	—
60 minutes	100	275	275	275	275	275	275	—	—	—	—	—	—
90 minutes	35	55	125	275	275	275	275	—	—	—	—	—	—
120 minutes	20	30	50	85	140	270	275	—	—	—	—	—	—
180 minutes	10	15	20	30	40	50	70	95	110	160	255	275	—
240 minutes	—	10	15	20	—	25	35	40	45	55	65	70	90

The thicknesses in above tables can be made up from a single layer or no more than two layers of PROMATECT® 50 board. For two layer application, secure the thinner layer first and stagger all joints between layers at minimum 300mm centres. For four sided encasement of column, install the second layer separately from the first layer and no gap is required between layers. For encasements of beam, screw the second layer to the first layer.

Continued on next page

Continued from previous page

Hp/A Ratio Table 2 Up to 240/-/- fire resistance in accordance with the requirements of **BS 476: Part 21: 1987** (report no. BRANZ FAR 3659) for **structural steel column protection at critical temperature of 620°C**

Fire resistance	PROMATECT® 50 board thickness (mm)												
	10	12	15	18	20	22	25	27	28	30	32	33	35
30 minutes	275	275	275	275	275	275	—	—	—	—	—	—	—
60 minutes	190	275	275	275	275	275	—	—	—	—	—	—	—
90 minutes	50	85	215	275	275	275	—	—	—	—	—	—	—
120 minutes	30	40	70	135	235	275	—	—	—	—	—	—	—
180 minutes	15	20	30	40	55	70	105	140	165	250	275	—	—
240 minutes	10	—	20	25	30	35	45	55	60	75	90	100	125

Hp/A Ratio Table 3 Up to 240/-/- fire resistance in accordance with the requirements of **BS 476: Part 21: 1987** (report no. BRANZ FAR 3659) for **structural steel beam protection at critical temperature of 550°C**

Fire resistance	PROMATECT® 50 board thickness (mm)												
	10	12	15	18	20	22	25	27	28	30	32	33	35
30 minutes	290	290	290	290	290	290	—	—	—	—	—	—	—
60 minutes	165	290	290	290	290	290	—	—	—	—	—	—	—
90 minutes	60	95	185	290	290	290	—	—	—	—	—	—	—
120 minutes	35	50	85	135	200	290	—	—	—	—	—	—	—
180 minutes	15	25	40	55	65	80	115	145	165	215	290	—	—
240 minutes	15	—	25	35	40	45	60	70	75	90	105	115	135

Hp/A Ratio Table 4 Up to 240/-/- fire resistance in accordance with the requirements of **BS 476: Part 21: 1987** (report no. BRANZ FAR 3659) for **structural steel beam protection at critical temperature of 620°C**

Fire resistance	PROMATECT® 50 board thickness (mm)												
	10	12	15	18	20	22	25	27	28	30	32	33	35
30 minutes	290	290	290	290	290	—	—	—	—	—	—	—	—
60 minutes	265	290	290	290	290	—	—	—	—	—	—	—	—
90 minutes	85	130	280	290	290	—	—	—	—	—	—	—	—
120 minutes	50	70	110	190	290	—	—	—	—	—	—	—	—
180 minutes	25	35	50	70	85	105	150	195	220	290	—	—	—
240 minutes	15	20	30	40	50	60	75	90	95	115	135	150	180

The thicknesses in above tables can be made up from a single layer or no more than two layers of PROMATECT® 50 board. For two layer application, secure the thinner layer first and stagger all joints between layers at minimum 300mm centres. For four sided encasement of column, install the second layer separately from the first layer and no gap is required between layers. For encasements of beam, screw the second layer to the first layer.

Continued on next page

Continued from previous page

Hp/A Ratio Table 5 Up to 240/-/- fire resistance in accordance with the requirements of **AS 1530: Part 4: 2005** (report no. BRANZ FAR 3657) for **structural steel column protection at critical temperature of 550°C**

Fire resistance	PROMATECT® 50 board thickness (mm)												
	10	12	15	18	20	22	25	27	28	30	32	33	35
30 minutes	255	255	255	255	255	255	—	—	—	—	—	—	—
60 minutes	145	255	255	255	255	255	—	—	—	—	—	—	—
90 minutes	—	80	150	255	255	255	—	—	—	—	—	—	—
120 minutes	—	—	—	95	150	255	—	—	—	—	—	—	—
180 minutes	—	—	—	—	—	—	—	—	—	150	250	—	—

Hp/A Ratio Table 6 Up to 240/-/- fire resistance in accordance with the requirements of **AS 1530: Part 4: 2005** (report no. BRANZ FAR 3657) for **structural steel column protection at critical temperature of 620°C**

Fire resistance	PROMATECT® 50 board thickness (mm)												
	10	12	15	18	20	22	25	27	28	30	32	33	35
30 minutes	255	255	255	255	255	—	—	—	—	—	—	—	—
60 minutes	240	255	255	255	255	—	—	—	—	—	—	—	—
90 minutes	75	110	255	255	255	—	—	—	—	—	—	—	—
120 minutes	—	—	85	150	255	—	—	—	—	—	—	—	—
180 minutes	—	—	—	—	—	—	—	140	180	250	—	—	—

Hp/A Ratio Table 7 Up to 240/-/- fire resistance in accordance with the requirements of **AS 1530: Part 4: 2005** (report no. BRANZ FAR 3657) for **structural steel beam protection at critical temperature of 550°C**

Fire resistance	PROMATECT® 50 board thickness (mm)												
	10	12	15	18	20	22	25	27	28	30	32	33	35
30 minutes	270	270	270	270	270	270	—	—	—	—	—	—	—
60 minutes	195	270	270	270	270	270	—	—	—	—	—	—	—
90 minutes	—	—	205	270	270	270	—	—	—	—	—	—	—
120 minutes	—	—	—	145	210	270	—	—	—	—	—	—	—
180 minutes	—	—	—	—	—	—	120	145	165	215	265	—	—
240 minutes	—	—	—	—	—	—	—	—	—	—	—	—	135

The thicknesses in above tables can be made up from a single layer or no more than two layers of PROMATECT® 50 board. For two layer application, secure the thinner layer first and stagger all joints between layers at minimum 300mm centres. For four sided encasement of column, install the second layer separately from the first layer and no gap is required between layers. For encasements of beam, screw the second layer to the first layer.

Continued on next page

Continued from previous page

Hp/A Ratio Table 8 Up to 240/-/- fire resistance in accordance with the requirements of **AS 1530: Part 4: 2005** (report no. BRANZ FAR 3657) for **structural steel beam protection at critical temperature of 620°C**

Fire resistance	PROMATECT® 50 board thickness (mm)												
	10	12	15	18	20	22	25	27	28	30	32	33	35
30 minutes	270	270	270	270	270	—	—	—	—	—	—	—	—
60 minutes	270	270	270	270	270	—	—	—	—	—	—	—	—
90 minutes	—	145	270	270	270	—	—	—	—	—	—	—	—
120 minutes	—	—	120	210	270	—	—	—	—	—	—	—	—
180 minutes	—	—	—	—	—	—	160	205	240	265	—	—	—
240 minutes	—	—	—	—	—	—	—	—	—	—	140	155	185

The thicknesses in above tables can be made up from a single layer or no more than two layers of PROMATECT® 50 board. For two layer application, secure the thinner layer first and stagger all joints between layers at minimum 300mm centres. For four sided encasement of column, install the second layer separately from the first layer and no gap is required between layers. For encasements of beam, screw the second layer to the first layer.

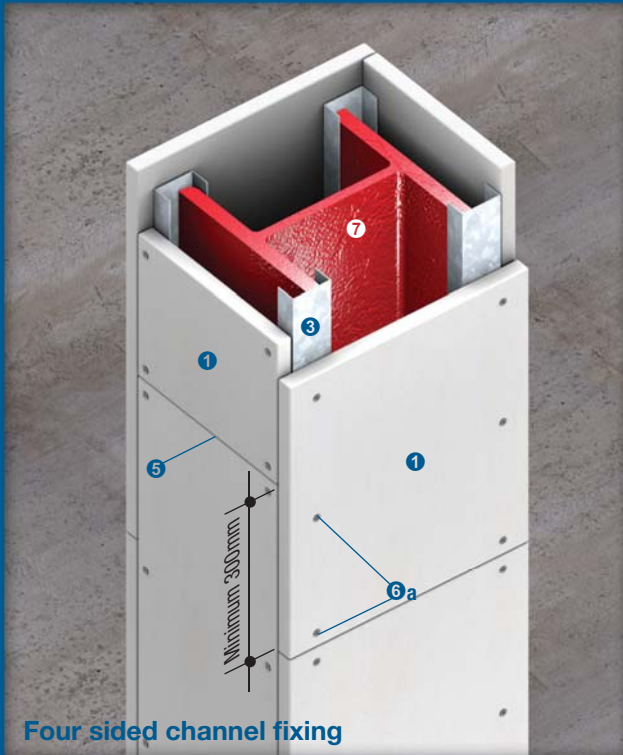

Four sided channel fixing

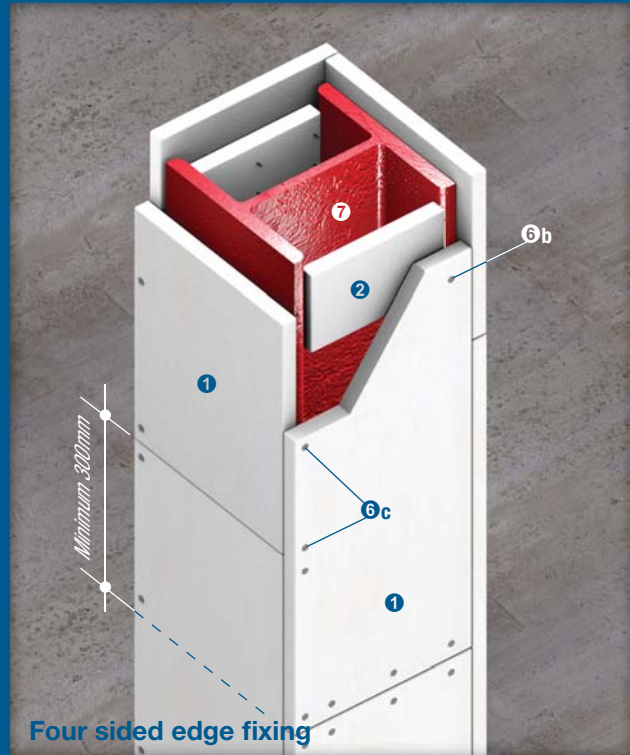

Four sided edge fixing

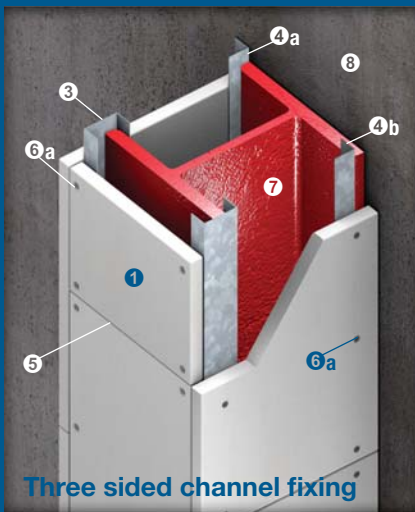

Three sided channel fixing



Three sided edge fixing

Up to 150/- fire resistance in accordance with the requirements of AS 1530: Part 4: 2005

- ① PROMATECT® 100 board, thickness in accordance with the Hp/A Ratio tables on page 46
- ② PROMATECT® 100 soldiers 100mm wide, minimum thickness similar to the board thickness of ①
- ③ Continuous galvanised steel channel 19mm x 38mm x 19mm x 0.8mm thick or similar, leg of each channel is located against inner surface of flange
- ④a Continuous galvanised steel angles minimum 32mm x 19mm x 0.8mm thick or similar fixed to the wall using non combustible proprietary anchors at nominal 500mm centres
- ④b Continuous galvanised steel angles minimum 32mm x 19mm x 0.8mm thick or similar fixed to the flange using Tek screws, shot fired nails or welding. Secure edges of side boards at 200mm centres
- ⑤ Horizontal joints in adjacent board sides to be staggered at minimum 300mm
For wide columns, it is advisable to include a PROMATECT® 100 cover strip behind the joints within the web of the steel column to provide additional impact resistance
- ⑥a Self-drilling or self-tapping drywall screws fixed to channel/angle at nominal 200mm centres. Screw length should be additional 20mm of the board thickness
- ⑥b Self-drilling or self-tapping drywall screws fixed to soldiers at nominal 100mm centres. Screw length should be additional 20mm of the board thickness
- ⑥c Steel wire staple fixing in accordance with table below. When edge fixing it is advisable to drill pilot holes, particularly with 15mm thick boards. Please consult Promat for further guidance

PROMATECT® 100 board thickness	Steel wire staples at 100mm centres
15mm	44/10/1mm
20mm	44/10/1mm
25mm	50/10/1mm
30mm	60/10/1mm

- ⑦ Structural steel column
- ⑧ Concrete wall substrate

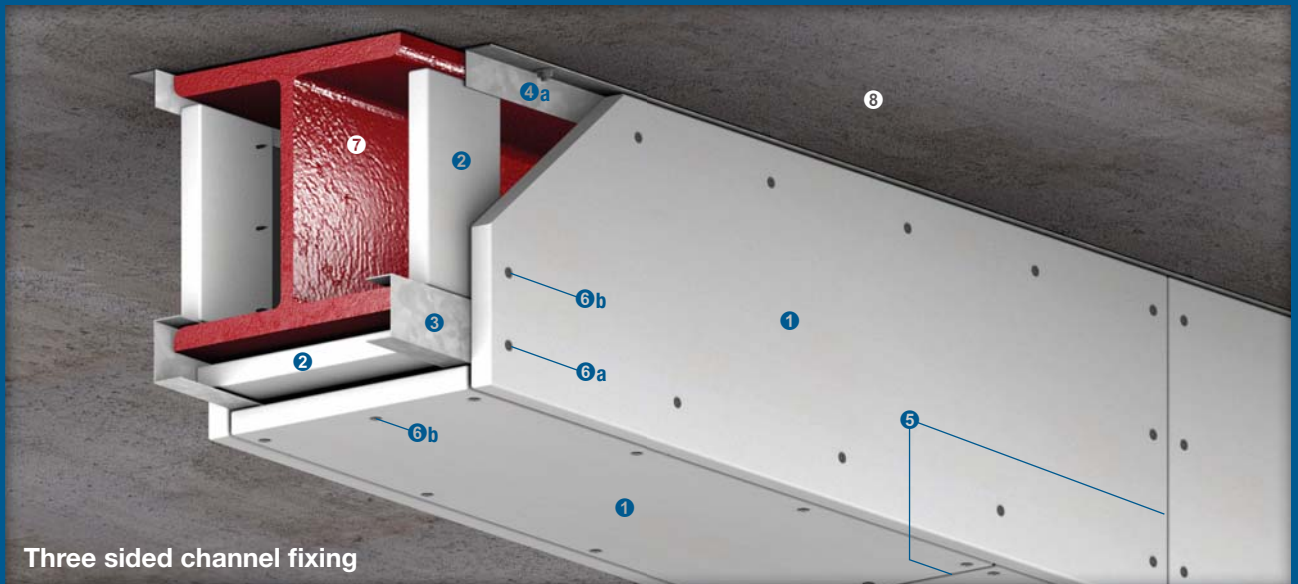

Three sided channel fixing

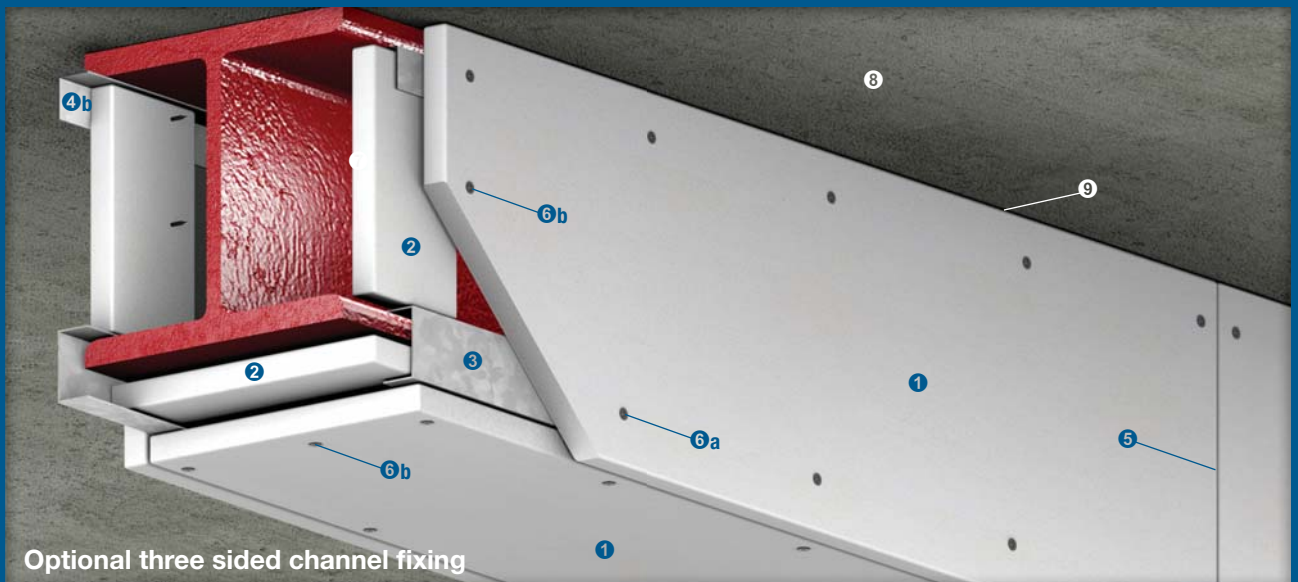

Optional three sided channel fixing

Up to 150/-/- fire resistance in accordance with the requirements of AS 1530: Part 4: 2005

- ❶ PROMATECT® 100 board, thickness in accordance with the Hp/A Ratio tables on page 46
- ❷ PROMATECT® 100 soldiers 100mm wide, minimum thickness similar to the board thickness of ❶, fixed within the web of the steel beam at maximum 1220mm centres behind the board joints using screws at 100mm centres or using staples at 50mm centres
For deep beams clad with thicker boards for greater fire resistance, it is advisable to fix the soldiers at nominal 600mm centres in order to reduce the load on the soldiers. For steel beams greater than 600mm deep, a T-section soldier should be used to provide a stronger support
- ❸ Continuous galvanised steel channel 19mm x 38mm x 19mm x 0.8mm thick or similar located at the bottom flange, leg of each channel is facing inner surface of the flange
- ❹a Continuous galvanised steel angles minimum 32mm x 19mm x 0.8mm thick or similar fixed to the floor slab using non combustible proprietary anchors at nominal 500mm centres
- ❹b Continuous galvanised steel angles minimum 32mm x 19mm x 0.8mm thick or similar beneath the upper flange
- ❺ Vertical and horizontal joints in adjacent board sides to be staggered at minimum 300mm
- ❻a Self-drilling or self-tapping drywall screws fixed to channel/angle at nominal 200mm centres. Screw length should be additional 20mm of the board thickness
- ❻b Self-drilling or self-tapping drywall screws fixed to soldiers at nominal 100mm centres. Screw length should be additional 20mm of the board thickness
- ❼ Structural steel beam
- ❽ Floor slab
- ❾ Caulk all edges between the board and the floor slab with PROMASEAL® AN Acrylic Sealant, depth in accordance with the required board thickness

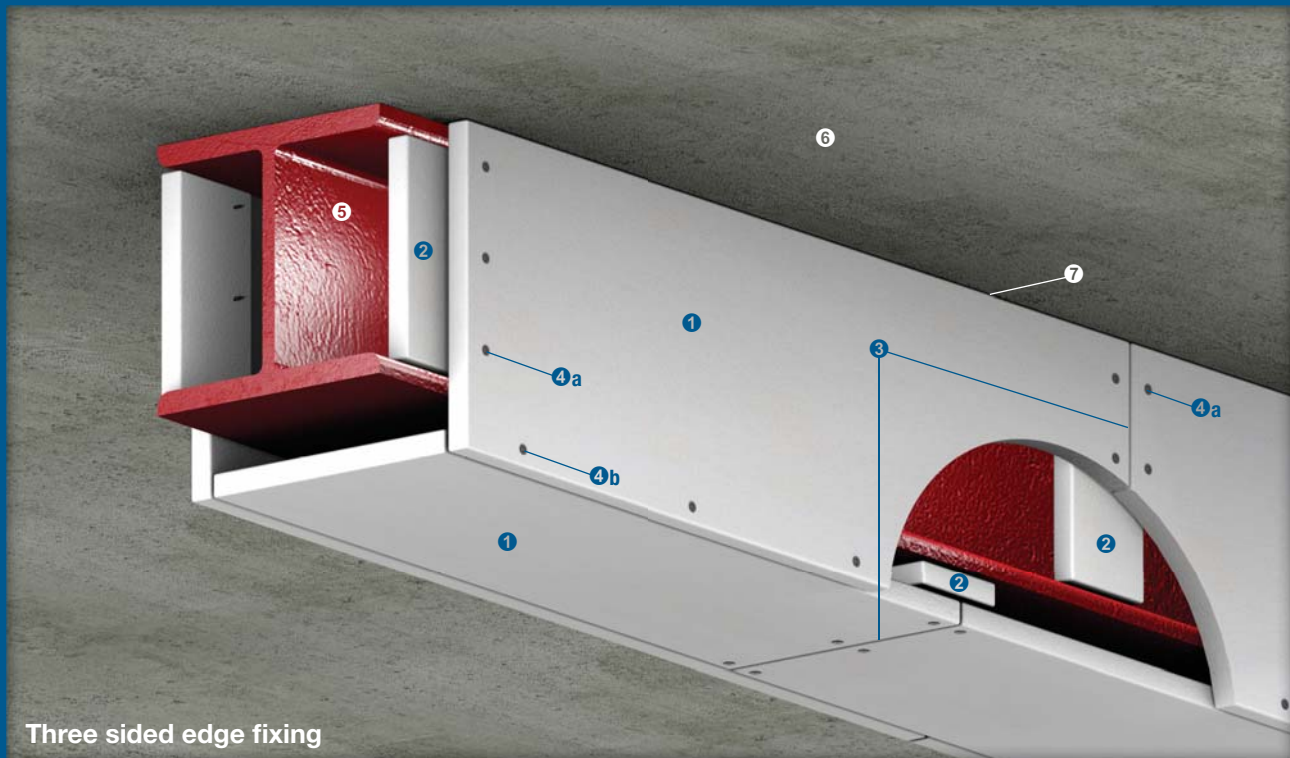

Three sided edge fixing

Up to 150/-/- fire resistance in accordance with the requirements of AS 1530: Part 4: 2005

- ❶ PROMATECT® 100 board, thickness in accordance with the Hp/A Ratio tables on page 46
- ❷ PROMATECT® 100 soldiers 100mm wide, minimum thickness similar to the board thickness of ❶, fixed within the web of the steel beam at maximum 1220mm centres behind the board joints using screws at 100mm centres or using staples at 50mm centres
For deep beams clad with thicker boards for greater fire resistance, it is advisable to fix the soldiers at nominal 600mm centres in order to reduce the load on the soldiers. For steel beams greater than 600mm deep, a T-section soldier should be used to provide a stronger support
- ❸ Vertical and horizontal joints in adjacent board sides to be staggered at minimum 300mm
- ❹a Self-drilling or self-tapping drywall screws fixed to soldiers at nominal 100mm centres. Screw length should be additional 20mm of the board thickness
- ❹b Steel wire staple fixing in accordance with table below. When edge fixing it is advisable to drill pilot holes, particularly with 15mm thick boards. Please consult Promat for further guidance

PROMATECT® 100 board thickness	Steel wire staples at 100mm centres
15mm	44/10/1mm
20mm	44/10/1mm
25mm	50/10/1mm
30mm	60/10/1mm

- ❺ Structural steel beam
- ❻ Floor slab
- ❼ Caulk all edges between the board and the floor slab with PROMASEAL® AN Acrylic Sealant, depth in accordance with the required board thickness

The following is a standard Architectural Specification for structural steel column and beam protection using PROMATECT® 100. Please note that PROMATECT® 100 can be installed by using either screw or staple type of edge fixing. The end user must determine the suitability of any particular design to meet the performance requirements of any application before undertaking any work. If in doubt, please first obtain the advice from a suitably qualified engineer.

The installation methods described herein are suitable for steel sections up to 686mm deep and 325mm wide. For larger section or when protecting multiple sections within a single encasement, please consult Promat.

Where a column box encasement abuts a beam protected with a profiled fire protection system, e.g. intumescent paint, the column webs should be sealed at their tops using PROMATECT® 100.

Fire Exposure & Area of Application

Exposed faces of steelwork internal to building, for up to 150 minute fire resistance in accordance with the requirements of AS 1530: Part 4: 2005.

Location

(1)

Type of Construction

_____ minute⁽²⁾ fire resistance to PROMATECT® 100 one sided, two sided, three sided or four sided encasement of structural steel columns and beams.

Lining Boards

_____mm⁽³⁾ thick PROMATECT® 100 PromaX® mineral boards as manufactured by Promat International (Asia Pacific) Ltd, in size _____mm x _____mm⁽⁴⁾, cut to size on-site/pre cut in accordance with the schedule of sizes⁽⁵⁾ and fixed in accordance with the manufacturer's recommended details and fixing instructions.

Screw Fixing

COLUMNS

PROMATECT® 100 boards to be fixed by board face to board edge using _____mm^(6a) self-drilling, self-tapping screws at nominal 200mm centres.

BEAMS

Vertical PROMATECT® 100 boards to be screwed to 100mm wide x _____mm⁽³⁾ thick PROMATECT® 100 soldiers wedged between flanges at 1200mm centres using _____mm^(6a) self-drilling, self-tapping screws at nominal 100mm centres.

Where mechanical fixing is required for columns or beams, PROMATECT® 100 boards to be fixed by board face to board edge using _____mm^(6a) self-drilling, self-tapping screws at nominal 200mm centres to nominal 19mm x 38mm x 19mm x 0.8mm continuous pressed steel channels or similar at bottom steel flange AND to 32mm x 19mm x 0.8mm continuous pressed steel angles secured to soffit of floor/roof slab or top steel flange. The angles should be fixed at nominal 500mm centres.

Staple Fixing

COLUMNS

PROMATECT® 100 boards to be fixed by board face to board edge using _____mm^(6b) staples at nominal 100mm centres.

BEAMS

Vertical PROMATECT® 100 boards to be screwed to 100mm wide x _____mm⁽³⁾ thick PROMATECT® 100 soldiers wedged between flanges at 1200mm centres using _____mm^(6b) staples at nominal 50mm centres.

Continued on next page

Continued from previous page

Butt Jointing For Screw Fixing

For beam casings only, PROMATECT® 100 board joints in the soffit to be backed with 100mm wide x minimum _____mm⁽⁵⁾ thick PROMATECT® 100 internal cover strips secured with _____mm⁽⁷⁾ self-drilling, self-tapping screws at nominal 100mm centres.

Butt Jointing For Staple Fixing

For beam casings only, PROMATECT® 100 board joints in the soffit to be backed with 100mm wide x minimum _____mm⁽⁵⁾ thick PROMATECT® 100 internal cover strips secured with _____mm⁽⁷⁾ staples to one side of board joint only.

Follow-on Trades

Surface of boards to be prepared for painting/plastering/tiling⁽⁶⁾ in accordance with manufacturer's recommendations.

NOTE:

- ⁽¹⁾ insert location, e.g. "beams and columns to offices interior", or provide steelwork drawing reference.
- ⁽²⁾ insert required fire resistance level not exceeding 150 minutes.
- ⁽³⁾ insert required thickness by reference to section factor (Hp/A) and fire resistance level.
- ⁽⁴⁾ select board size on basis of economy in cutting. Standard board size is 2500mm x 1200mm.
- ^{(5), (6)} delete as appropriate.
- ^(6a) insert screw length which gives minimum 25mm penetration having regard to encasement thickness.
- ^(6b) insert staple length which gives minimum 25mm penetration having regard to encasement thickness.
- ⁽⁷⁾ insert screw length which is minimum 5mm longer than twice the encasement thickness.

Hp/A Ratio Table 1 Up to 150/-/- fire resistance in accordance with the requirements of **AS 1530: Part 4: 2005** (report no. BRANZ FAR 3015) for **structural steel column protection at critical temperature of 550°C**

Fire resistance	PROMATECT® 100 board thickness (mm)					
	15	20	25	30 (15 x 2 layers)	35 (20 + 15, 1 layer each)	40 (20 x 2 layers)
30 minutes	260	260	260	260	260	260
60 minutes	260	260	260	260	260	260
90 minutes	114	185	260	260	260	260
120 minutes	68	102	145	201	260	260
150 minutes	—	70	96	126	163	190

Hp/A Ratio Table 2 Up to 150/-/- fire resistance in accordance with the requirements of **AS 1530: Part 4: 2005** (report no. BRANZ FAR 3015) for **structural steel beam protection at critical temperature of 550°C**

Fire resistance	PROMATECT® 100 board thickness (mm)					
	15	20	25	30 (15 x 2 layers)	35 (20 + 15, 1 layer each)	40 (20 x 2 layers)
30 minutes	260	260	260	260	260	260
60 minutes	260	260	260	260	260	260
90 minutes	102	162	249	260	260	260
120 minutes	—	92	129	176	238	260
150 minutes	—	—	87	114	146	168

Hp/A Ratio Table 3 Up to 150/-/- fire resistance in accordance with the requirements of **AS 1530: Part 4: 2005** (report no. BRANZ FAR 3015) for **structural steel beam protection at critical temperature of 620°C**

Fire resistance	PROMATECT® 100 board thickness (mm)					
	15	20	25	30 (15 x 2 layers)	35 (20 + 15, 1 layer each)	40 (20 x 2 layers)
30 minutes	260	260	260	260	260	260
60 minutes	260	260	260	260	260	260
90 minutes	115	232	249	260	260	260
120 minutes	—	94	149	243	260	260
150 minutes	—	—	85	120	171	213

For single layer application of ≥30mm thick PROMATECT® 100 board, please consult Promat.

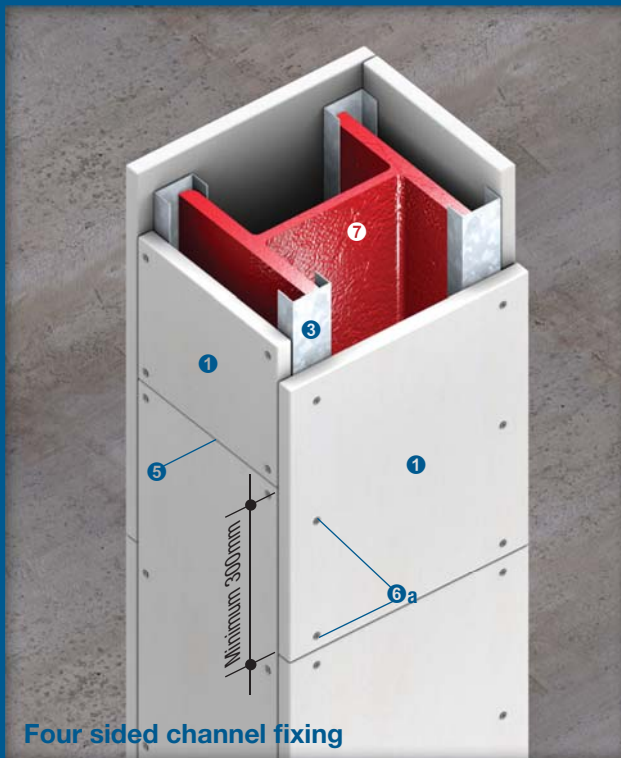

Four sided channel fixing

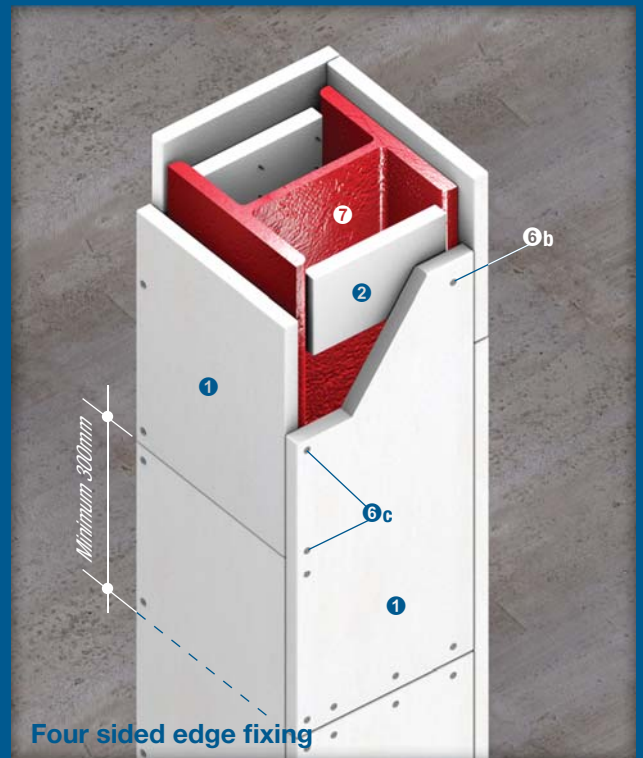

Four sided edge fixing

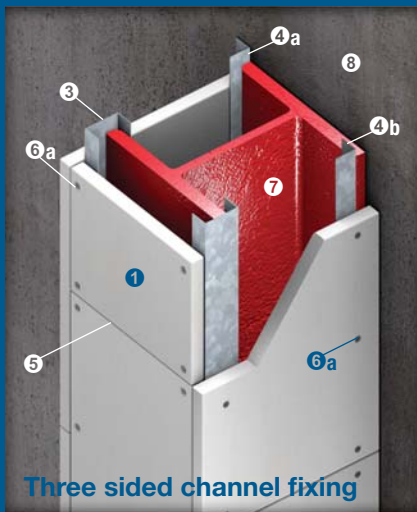

Three sided channel fixing



Three sided edge fixing

Up to 150/- fire resistance in accordance with the requirements of BS 476: Part 21: 1987

- ① PROMATECT® 250 board, thickness in accordance with the Hp/A Ratio tables on page 51
- ② PROMATECT® 250 soldiers 100mm wide, minimum thickness similar to the board thickness of ①
- ③ Continuous galvanised steel channel 19mm x 38mm x 19mm x 0.8mm thick or similar, leg of each channel is located against inner surface of flange
- ④a Continuous galvanised steel angles minimum 32mm x 19mm x 0.8mm thick or similar fixed to the wall using non combustible proprietary anchors at nominal 500mm centres
- ④b Continuous galvanised steel angles minimum 32mm x 19mm x 0.8mm thick or similar fixed to the flange using Tek screws, shot fired nails or welding. Secure edges of side boards at 200mm centres
- ⑤ Horizontal joints in adjacent board sides to be staggered at minimum 300mm
For wide columns, it is advisable to include a PROMATECT® 250 cover strip behind the joints within the web of the steel column to provide additional impact resistance
- ⑥a Self-drilling or self-tapping drywall screws fixed to channel/angle at nominal 200mm centres. Screw length should be additional 20mm of the board thickness
- ⑥b Self-drilling or self-tapping drywall screws fixed to soldiers at nominal 100mm centres. Screw length should be additional 20mm of the board thickness
- ⑥c Steel wire staple fixing in accordance with table below. When edge fixing it is advisable to drill pilot holes, particularly with 15mm thick boards. Please consult Promat for further guidance

PROMATECT® 250 board thickness	Steel wire staples at 100mm centres
15mm	44/10/1mm
20mm	44/10/1mm
25mm	50/10/1mm
30mm	60/10/1mm

- ⑦ Structural steel column
- ⑧ Concrete wall substrate

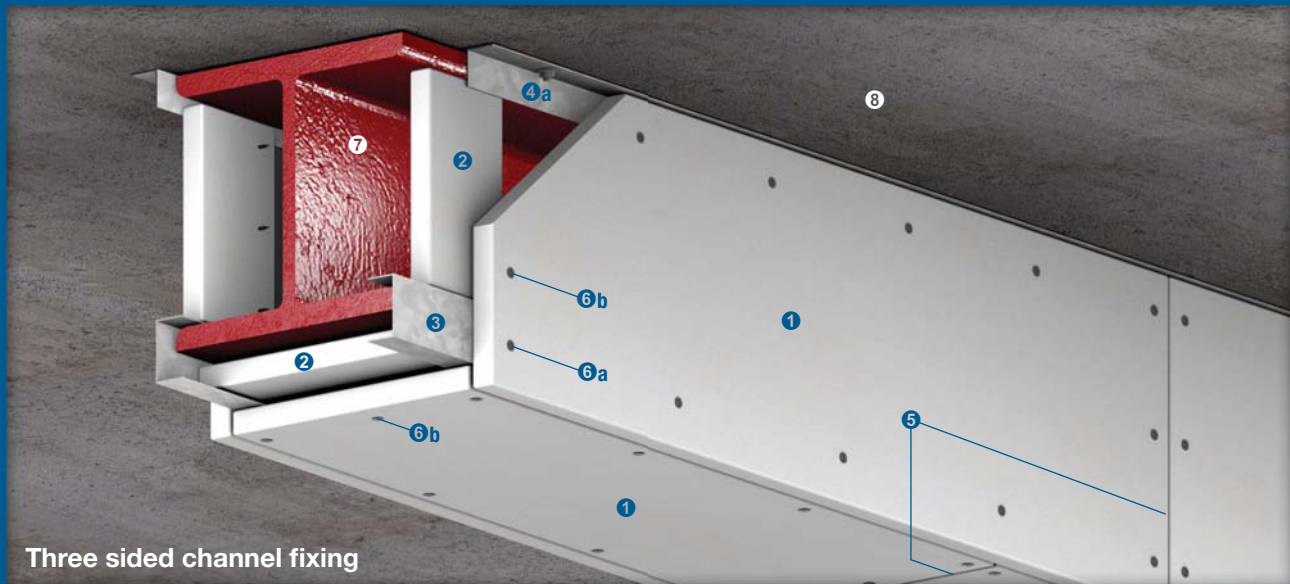

Three sided channel fixing

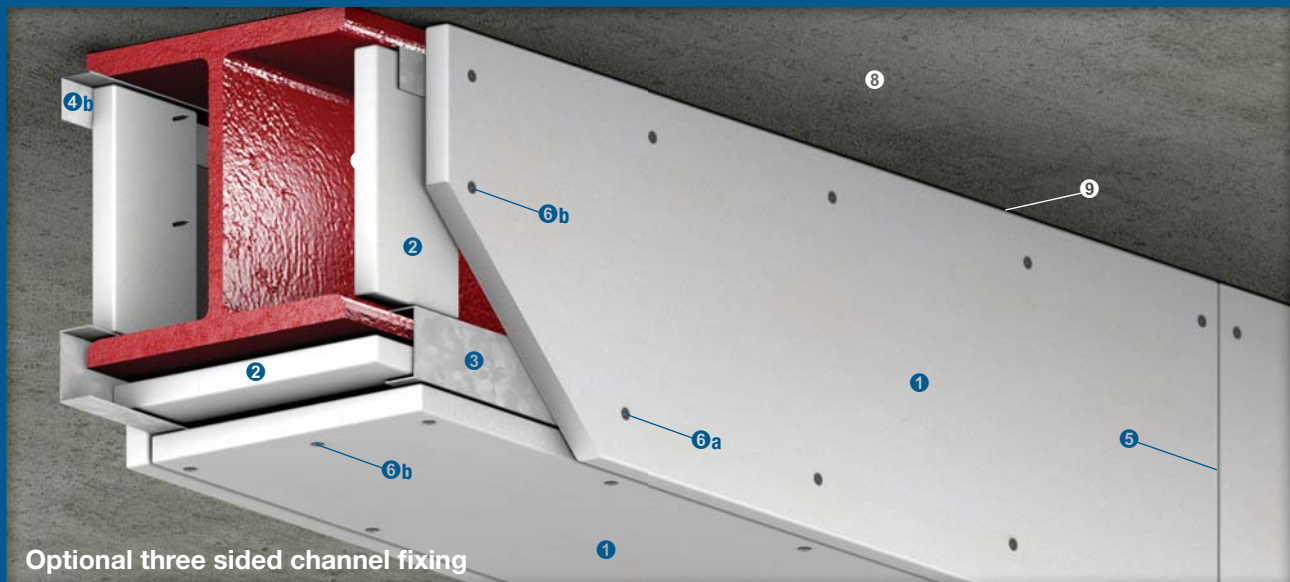

Optional three sided channel fixing

Up to 150/-/- fire resistance in accordance with the requirements of AS 1530: Part 4: 2005

- ① PROMATECT® 250 board, thickness in accordance with the Hp/A Ratio tables on page 51
- ② PROMATECT® 250 soldiers 100mm wide, minimum thickness similar to the board thickness of ①, fixed within the web of the steel beam at maximum 1220mm centres behind the board joints using screws at 100mm centres or using staples at 50mm centres
For deep beams clad with thicker boards for greater fire resistance, it is advisable to fix the soldiers at nominal 600mm centres in order to reduce the load on the soldiers. For steel beams greater than 600mm deep, a T-section soldier should be used to provide a stronger support
- ③ Continuous galvanised steel channel 19mm x 38mm x 19mm x 0.8mm thick or similar located at the bottom flange, leg of each channel is facing inner surface of the flange
- ④a Continuous galvanised steel angles minimum 32mm x 19mm x 0.8mm thick or similar fixed to the floor slab using non combustible proprietary anchors at nominal 500mm centres

- ④b Continuous galvanised steel angles minimum 32mm x 19mm x 0.8mm thick or similar beneath the upper flange
- ⑤ Vertical and horizontal joints in adjacent board sides to be staggered at minimum 300mm
- ⑥a Self-drilling or self-tapping drywall screws fixed to channel/angle at nominal 200mm centres. Screw length should be additional 20mm of the board thickness
- ⑥b Self-drilling or self-tapping drywall screws fixed to soldiers at nominal 100mm centres. Screw length should be additional 20mm of the board thickness
- ⑦ Structural steel beam
- ⑧ Floor slab
- ⑨ Caulk all edges between the board and the floor slab with PROMASEAL® AN Acrylic Sealant, depth in accordance with the required board thickness

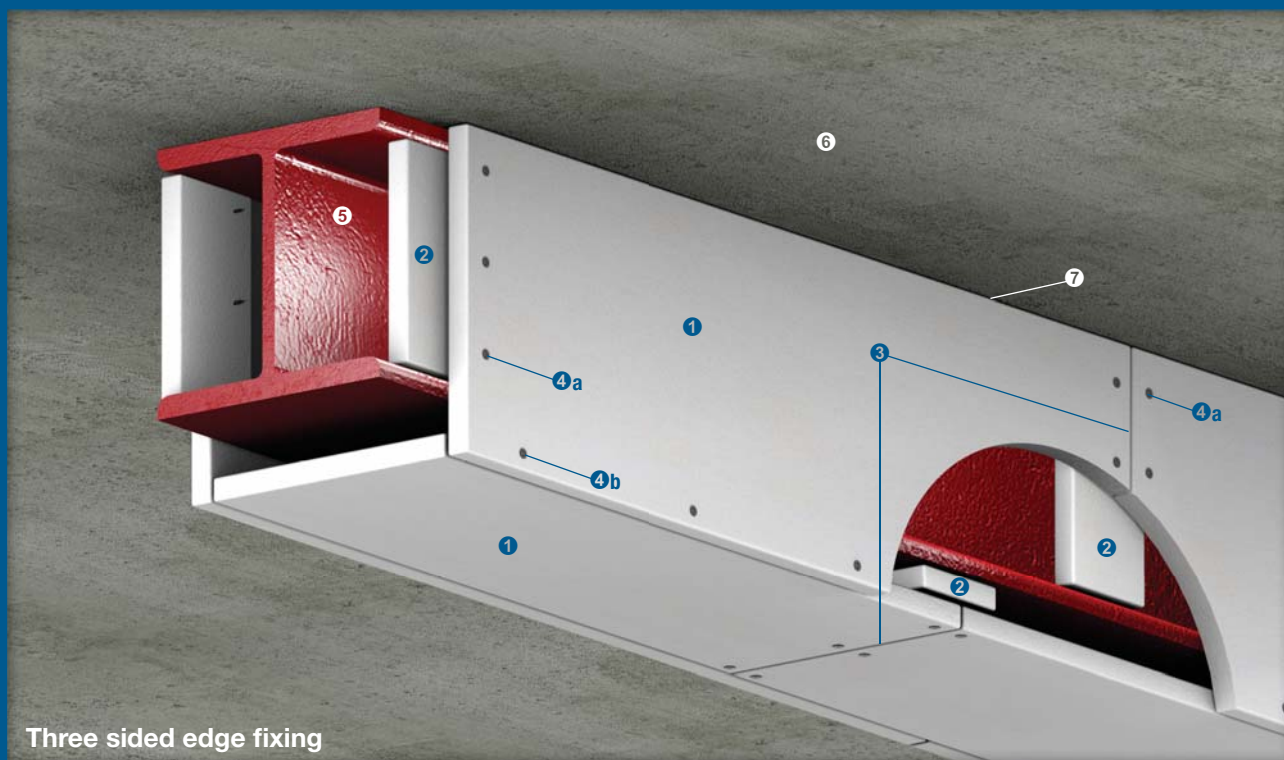

Three sided edge fixing

Up to 150/- fire resistance in accordance with the requirements of AS 1530: Part 4: 2005

- ❶ PROMATECT® 250 board, thickness in accordance with the Hp/A Ratio tables on page 51
- ❷ PROMATECT® 250 soldiers 100mm wide, minimum thickness similar to the board thickness of ❶, fixed within the web of the steel beam at maximum 1220mm centres behind the board joints using screws at 100mm centres or using staples at 50mm centres
For deep beams clad with thicker boards for greater fire resistance, it is advisable to fix the soldiers at nominal 600mm centres in order to reduce the load on the soldiers. For steel beams greater than 600mm deep, a T-section soldier should be used to provide a stronger support
- ❸ Vertical and horizontal joints in adjacent board sides to be staggered at minimum 300mm
- ❹a Self-drilling or self-tapping drywall screws fixed to soldiers at nominal 100mm centres. Screw length should be additional 20mm of the board thickness
- ❹b Steel wire staple fixing in accordance with table below. When edge fixing it is advisable to drill pilot holes, particularly with 15mm thick boards. Please consult Promat for further guidance

PROMATECT® 250 board thickness	Steel wire staples at 100mm centres
15mm	44/10/1mm
20mm	44/10/1mm
25mm	50/10/1mm
30mm	60/10/1mm

- ❺ Structural steel beam
- ❻ Floor slab
- ❼ Caulk all edges between the board and the floor slab with PROMASEAL® AN Acrylic Sealant, depth in accordance with the required board thickness

The following is a standard Architectural Specification for structural steel column and beam protection using PROMATECT® 250. Please note that PROMATECT® 250 can be installed by using either screw or staple type of edge fixing. The end user must determine the suitability of any particular design to meet the performance requirements of any application before undertaking any work. If in doubt, please first obtain the advice from a suitably qualified engineer.

The installation methods described herein are suitable for steel sections up to 686mm deep and 325mm wide. For larger section or when protecting multiple sections within a single encasement, please consult Promat.

Where a column box encasement abuts a beam protected with a profiled fire protection system, e.g. intumescent paint, the column webs should be sealed at their tops using PROMATECT® 250.

Fire Exposure & Area of Application

Exposed faces of steelwork internal to building, for up to 150 minute fire resistance in accordance with the requirements of BS 476: Part 21: 1987.

Location

(1)

Type of Construction

_____ minute⁽²⁾ fire resistance to PROMATECT® 250 one sided, two sided, three sided or four sided encasement of structural steel columns and beams.

Lining Boards

_____mm⁽³⁾ thick PROMATECT® 250 PromaX® mineral boards as manufactured by Promat International (Asia Pacific) Ltd, in size _____mm x _____mm⁽⁴⁾, cut to size on-site/pre cut in accordance with the schedule of sizes⁽⁵⁾ and fixed in accordance with the manufacturer's recommended details and fixing instructions.

Screw Fixing

COLUMNS

PROMATECT® 250 boards to be fixed by board face to board edge using _____mm^(6a) self-drilling, self-tapping screws at nominal 200mm centres.

BEAMS

Vertical PROMATECT® 250 boards to be screwed to 100mm wide x _____mm⁽³⁾ thick PROMATECT® 250 soldiers wedged between flanges at 1200mm centres using _____mm^(6a) self-drilling, self-tapping screws at nominal 100mm centres.

Where mechanical fixing is required for columns or beams, PROMATECT® 250 boards to be fixed by board face to board edge using _____mm^(6a) self-drilling, self-tapping screws at nominal 200mm centres to nominal 19mm x 38mm x 19mm x 0.8mm continuous pressed steel channels or similar at bottom steel flange AND to 32mm x 19mm x 0.8mm continuous pressed steel angles secured to soffit of floor/roof slab or top steel flange. The angles should be fixed at nominal 500mm centres.

Staple Fixing

COLUMNS

PROMATECT® 250 boards to be fixed by board face to board edge using _____mm^(6b) staples at nominal 100mm centres.

BEAMS

Vertical PROMATECT® 250 boards to be screwed to 100mm wide x _____mm⁽³⁾ thick PROMATECT® 250 soldiers wedged between flanges at 1200mm centres using _____mm^(6b) staples at nominal 50mm centres.

Where mechanical fixing is required for columns or beams, PROMATECT® 250 boards to be fixed by board face to board edge using _____mm^(6b) staples at nominal 100mm centres to nominal 19mm x 38mm x 19mm x 0.8mm continuous pressed steel channels or similar at bottom steel flange AND to 32mm x 19mm x 0.8mm continuous pressed steel angles secured to soffit of floor/roof slab or top steel flange. The angles should be fixed at nominal 500mm centres.

Continued on next page

Continued from previous page

Butt Jointing For Screw Fixing

For beam casings only, PROMATECT® 250 board joints in the soffit to be backed with 100mm wide x minimum _____mm⁽³⁾ thick PROMATECT® 250 internal cover strips secured with _____mm⁽⁷⁾ self-drilling, self-tapping screws at nominal 100mm centres.

Butt Jointing For Staple Fixing

For beam casings only, PROMATECT® 250 board joints in the soffit to be backed with 100mm wide x minimum _____mm⁽³⁾ thick PROMATECT® 250 internal cover strips secured with _____mm⁽⁷⁾ staples to one side of board joint only.

Follow-on Trades

Surface of boards to be prepared for painting/plastering/tiling⁽⁸⁾ in accordance with manufacturer's recommendations.

NOTE:

- ⁽¹⁾ insert location, e.g. "beams and columns to offices interior", or provide steelwork drawing reference.
- ⁽²⁾ insert required fire resistance level not exceeding 150 minutes.
- ⁽³⁾ insert required thickness by reference to section factor (Hp/A) and fire resistance level.
- ⁽⁴⁾ select board size on basis of economy in cutting. Standard board size is 2500mm x 1200mm.
- ^{(5), (6)} delete as appropriate.
- ^(6a) insert screw length which gives minimum 25mm penetration having regard to encasement thickness.
- ^(6b) insert staple length which gives minimum 25mm penetration having regard to encasement thickness.
- ⁽⁷⁾ insert screw length which is minimum 5mm longer than twice the encasement thickness.

Hp/A Ratio Table 1 Up to 150/-/- fire resistance in accordance with the requirements of **BS 476: Part 21: 1987** (report no. BRE CC 94174) for **structural steel column protection at critical temperature of 550°C**

Fire resistance	PROMATECT® 250 board thickness (mm)														
	15	18	20	22	25	27	28	30	32	33	34	35	36	37	38
30 minutes	260	260	260	260	260	260	260	260	260	260	260	260	260	260	260
60 minutes	260	260	260	260	260	260	260	260	260	260	260	260	260	260	260
90 minutes	114	153	185	223	260	260	260	260	260	260	260	260	260	260	260
120 minutes	68	87	102	118	145	165	176	201	228	243	260	260	260	260	260
150 minutes	—	61	70	80	96	107	113	126	140	147	155	163	172	180	190

Hp/A Ratio Table 2 Up to 150/-/- fire resistance in accordance with the requirements of **BS 476: Part 21: 1987** (report no. BRE CC 94174) for **structural steel column protection at critical temperature of 620°C**

Fire resistance	PROMATECT® 250 board thickness (mm)														
	15	18	20	22	25	27	28	30	32	33	34	35	36	37	38
30 minutes	260	260	260	260	260	260	260	260	260	260	260	260	260	260	260
60 minutes	260	260	260	260	260	260	260	260	260	260	260	260	260	260	260
90 minutes	142	227	260	260	260	260	260	260	260	260	260	260	260	260	260
120 minutes	67	92	112	137	186	231	259	260	260	260	260	260	260	260	260
150 minutes	—	57	68	79	99	115	124	144	168	182	197	214	232	253	260

Hp/A Ratio Table 3 Up to 150/-/- fire resistance in accordance with the requirements of **BS 476: Part 21: 1987** (report no. BRE CC 94174) for **structural steel beam protection at critical temperature of 550°C**

Fire resistance	PROMATECT® 250 board thickness (mm)														
	15	18	20	22	25	27	28	30	32	33	34	35	36	37	38
30 minutes	260	260	260	260	260	260	260	260	260	260	260	260	260	260	260
60 minutes	260	260	260	260	260	260	260	260	260	260	260	260	260	260	260
90 minutes	102	135	162	192	249	260	260	260	260	260	260	260	260	260	260
120 minutes	—	—	92	106	129	146	156	176	199	211	224	238	256	260	260
150 minutes	—	—	—	—	87	97	102	114	126	132	139	145	153	160	168

Hp/A Ratio Table 4 Up to 150/-/- fire resistance in accordance with the requirements of **BS 476: Part 21: 1987** (report no. BRE CC 94174) for **structural steel beam protection at critical temperature of 620°C**

Fire resistance	PROMATECT® 250 board thickness (mm)														
	15	18	20	22	25	27	28	30	32	33	34	35	36	37	38
30 minutes	260	260	260	260	260	260	260	260	260	260	260	260	260	260	260
60 minutes	260	260	260	260	260	260	260	260	260	260	260	260	260	260	260
90 minutes	115	173	232	260	260	260	260	260	260	260	260	260	260	260	260
120 minutes	—	—	94	113	149	180	198	243	260	260	260	260	260	260	260
150 minutes	—	—	—	—	85	98	105	120	138	148	159	171	183	197	213

For single layer application of ≥30mm thick PROMATECT® 250 board, please consult Promat.

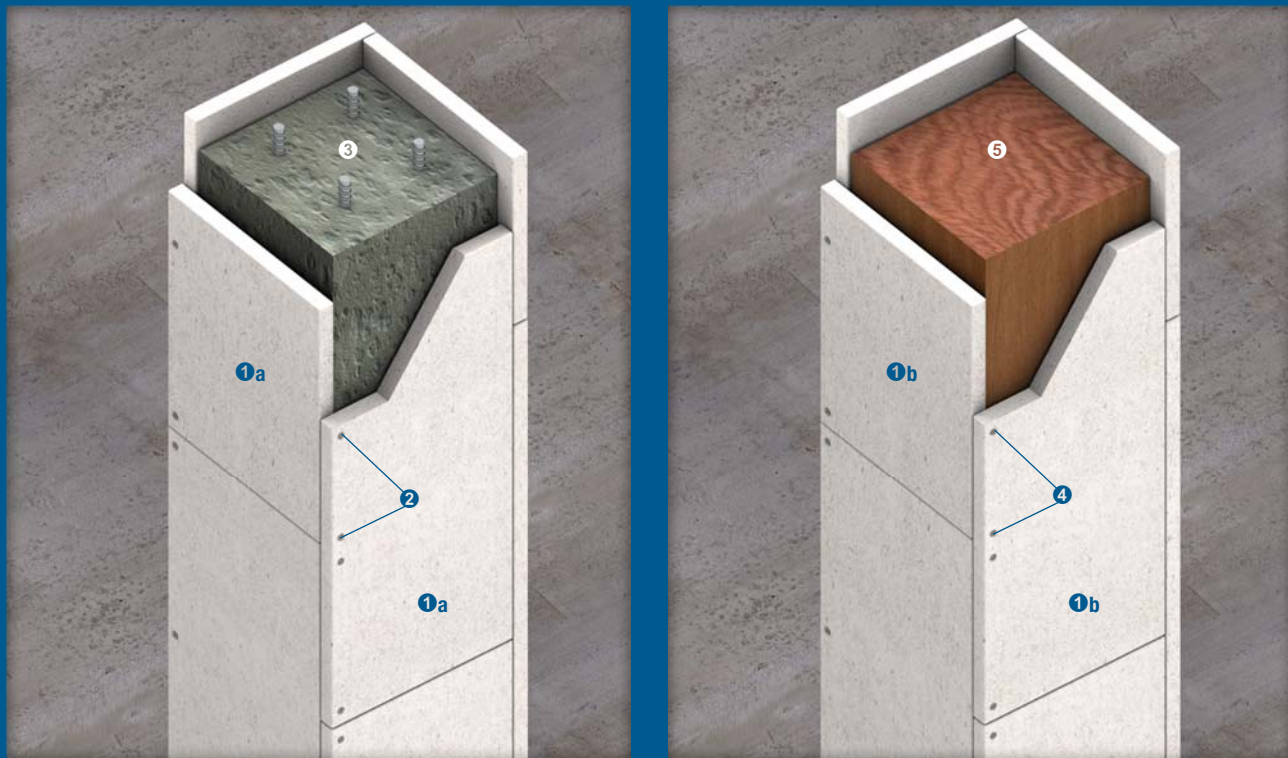

Up to 120/-/- fire resistance upgrading to concrete and timber structures

❶a PROMATECT®-H board, thickness in accordance with the required fire resistance level and determined by a number of factors of the concrete column section required for cladding, e.g. the concrete density, type of aggregate, cover to reinforcement, type of fire curve etc

❶b PROMATECT®-H board, thickness in accordance with the required fire resistance level and determined by a number of factors of the timber column section required for cladding, e.g. dimension, species, the required residual dimension and strength etc

Note that defining timber simply as a hard or softwood is inadequate when attempting to discern its charring rate. Different species of wood will behave differently under fire conditions, not only in their rate of charring but also in their behaviour to bow and twist severely

❷ Minimum 25mm penetration of fixings by board face to board edge for >15mm thick board cladding. Avoid fixing to the concrete

❸ Structural concrete column

❹ Fixings using nails or screws, length in accordance with the required fire resistance level and determined by the type of timber

❺ Structural timber column minimum 120mm x 120mm

Please consult Promat for details of structural concrete and timber column claddings using PROMATECT®-H board

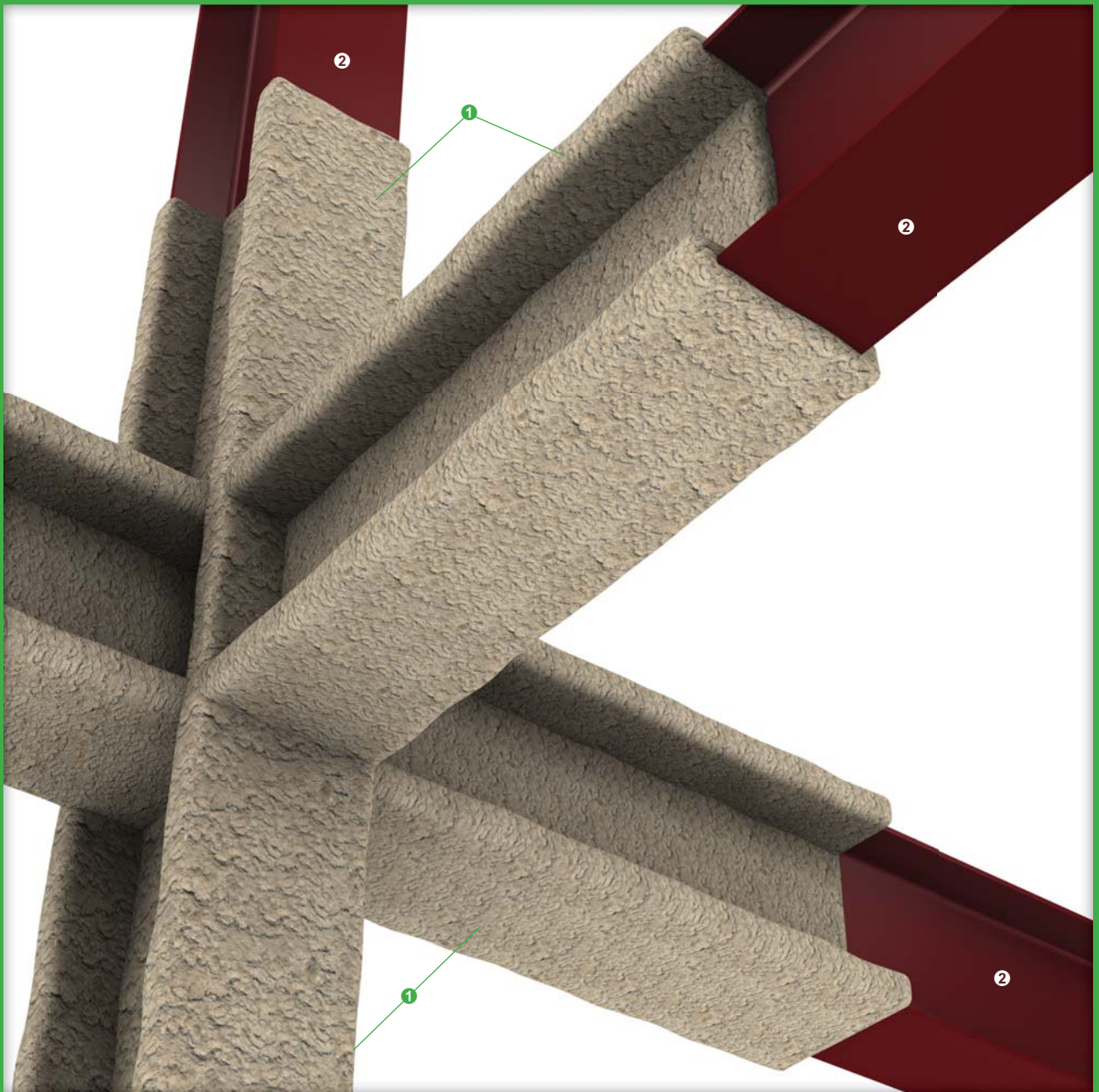

Up to 240/-/ fire resistance in accordance with the requirements of BS 476: Part 21: 1987, AS 1530: Part 4: 2005 and ASTM E119: 2007*

- ① Spray or trowel applied CAFCO® 300 vermiculite and gypsum based wet mix, thickness in accordance with Hp/A Ratio tables on pages 54 to 57
- ② Application to unprimed or compatible primed surfaces. Substrate to be clean, dry and free from dust, loose mill scale, loose rust, oil and any other condition preventing good adhesion

For non compatible primers, spray or brush apply Cafco BONDSEAL® styrene acrylic copolymer as keycoat prior to the application of CAFCO® 300

Mesh reinforcement may be required in the following conditions:

- There is no re-entrant detail on the structural steel substrate
- The structural steel substrate is subject to vibration
- Dimension of an 'I' or 'H' structural steel section exceeds 650mm between flanges and/or exceeds 325mm across flanges
- Diameter of a circular structural steel section exceeds 325mm
- Diameter of a single face hollow structural steel section exceeds 325mm

* Please consult Promat for application in accordance with the requirements of ASTM E119: 2007

Hp/A Ratio Table 1 Up to 240/-/- fire resistance in accordance with the requirements of **BS 476: Part 21: 1987** (report no. BRE CC250717 Issue 2) for **universal column and four sided beam sections of structural steel protection at critical temperature of 550°C**

Hp/A	CAFCO® 300 coating thickness when cured (mm)					
	30 minutes	60 minutes	90 minutes	120 minutes	180 minutes	240 minutes
30	10	10	10	12	18	23
40	10	10	12	15	21	28
50	10	10	13	17	24	32
60	10	10	15	19	27	35
70	10	11	16	20	29	38
80	10	12	17	22	31	41
90	10	13	18	23	33	43
100	10	13	18	24	34	45
110	10	14	19	25	36	47
120	10	14	20	25	37	48
130	10	15	20	26	38	49
140	10	15	21	27	39	51
150	10	15	21	27	40	52
160	10	16	22	28	40	53
170	10	16	22	29	41	54
180	10	16	23	29	42	55
190	10	16	23	29	43	56
200	10	17	23	30	43	56
210	10	17	23	30	44	57
220	10	17	24	31	44	58
230	10	17	24	31	45	58
240	10	17	24	31	45	59
250	10	17	24	31	45	59
260	10	18	25	32	46	60
270	11	18	25	32	46	60
280	11	18	25	32	47	61
290	11	18	25	32	47	61
300	11	18	25	33	47	62
310	11	18	25	33	47	62
320	11	18	26	33	48	62
330	11	18	26	33	48	63

NOTE: Figures are accurate at time of publication. Maximum critical temperatures for fully loaded structural steel members are normally accepted at 550°C for four sided column protection and at 620°C for three sided beam protection as a support to composite concrete floors.

Hp/A Ratio Table 2 Up to 240/-/- fire resistance in accordance with the requirements of **BS 476: Part 21: 1987** (report no. BRE CC250717 Issue 2) for **three sided 'I' section of structural steel beam protection (where the beam forms part of a composite action concrete of the floor slab) at critical temperature of 620°C**

Hp/A	CAFCO® 300 coating thickness when cured (mm)					
	30 minutes	60 minutes	90 minutes	120 minutes	180 minutes	240 minutes
30	10	10	10	11	16	21
40	10	10	10	13	19	25
50	10	10	12	15	22	28
60	10	10	13	17	24	32
70	10	10	14	18	26	34
80	10	10	15	19	28	36
90	10	11	16	20	29	38
100	10	11	16	21	31	40
110	10	12	17	22	32	42
120	10	12	17	23	33	43
130	10	12	18	23	34	44
140	10	13	18	24	35	46
150	10	13	19	24	36	47
160	10	14	19	25	36	48
170	10	14	20	25	37	49
180	10	14	20	26	38	49
190	10	14	20	26	38	50
200	10	14	20	27	39	51
210	10	15	21	27	39	51
220	10	15	21	27	40	52
230	10	15	21	27	40	53
240	10	15	21	28	40	53
250	10	15	22	28	41	54
260	10	15	22	28	41	54
270	10	15	22	28	41	54
280	10	16	22	29	42	55
290	10	16	22	29	42	55
300	10	16	22	29	42	56
310	10	16	23	29	43	56

NOTE: Figures are accurate at time of publication. Maximum critical temperatures for fully loaded structural steel members are normally accepted at 550°C for four sided column protection and at 620°C for three sided beam protection as a support to composite concrete floors.

Hp/A Ratio Table 3 Up to 240/-/- fire resistance in accordance with the requirements of **AS 1530: Part 4: 2005** (report no. BRANZ FAR 3317) for **four sided 'H' section of structural steel column protection at critical temperature of 550°C**

E (m ² /t)	Hp/A	CAFCO® 300 coating thickness when cured (mm)				
		60 minutes	90 minutes	120 minutes	180 minutes	240 minutes
9	70	14	19	24	37	52
10	75	14	19	24	37	52
10	80	14	19	24	37	52
11	85	14	19	24	37	52
12	90	14	19	24	37	52
12	95	14	19	24	37	52
13	100	14	19	24	37	52
13	105	14	19	24	37	52
14	110	14	19	24	37	52
15	115	14	19	24	37	52
15	120	14	19	24	37	52
16	125	14	19	24	37	52
17	130	14	19	25	37	52
17	135	14	19	25	38	52
18	140	14	19	25	38	52
19	145	14	19	26	39	52
19	150	14	20	26	39	52
20	155	14	20	26	40	53
20	160	14	20	27	40	53
21	165	14	20	27	41	54
22	170	14	21	27	41	54
22	175	14	21	28	41	54
23	180	14	21	28	41	55
24	185	14	21	28	42	55
24	190	15	21	28	42	55
25	195	15	22	28	42	56
26	200	15	22	29	42	56
26	205	15	22	29	43	56
27	210	15	22	29	43	57
28	215	15	22	29	43	57
29	220	16	23	30	44	57
29	225	16	23	30	44	58
30	230	16	23	30	44	58
31	235	16	23	30	44	58
31	240	16	23	30	44	58
32	245	16	23	30	44	59
33	250	16	23	30	45	59
33	255	16	23	31	45	59
34	260	16	24	31	45	59
34	265	17	24	31	45	—
35	270	17	24	31	45	—
36	275	17	24	31	45	—
36	280	17	24	31	46	—
37	285	17	24	31	46	—

NOTE: Figures are accurate at time of publication. Maximum critical temperatures for fully loaded structural steel members are normally accepted at 550°C for four sided column protection and at 620°C for three sided beam protection as a support to composite concrete floors.

Hp/A Ratio Table 4 Up to 240/-/- fire resistance in accordance with the requirements of **AS 1530: Part 4: 2005** (report no. BRANZ FAR 3317) for **three sided 'I' section of structural steel beam protection (where the beam forms part of a composite action concrete of the floor slab) at critical temperature of 620°C**

E (m ² /t)	Hp/A	CAFCO® 300 coating thickness when cured (mm)				
		60 minutes	90 minutes	120 minutes	180 minutes	240 minutes
9	70	14	17	17	31	46
10	75	14	17	17	31	46
10	80	14	17	17	31	46
11	85	14	17	17	31	46
12	90	14	17	17	31	46
12	95	14	17	17	31	46
13	100	14	17	17	31	46
13	105	14	17	17	31	46
14	110	14	17	17	31	46
15	115	14	17	17	32	46
15	120	14	17	21	32	46
16	125	14	17	21	33	46
17	130	14	17	22	33	46
17	135	14	17	22	34	46
18	140	14	17	22	34	46
19	145	14	17	23	35	47
19	150	14	17	23	35	47
20	155	14	17	23	36	48
20	160	14	18	24	36	48
21	165	14	18	24	36	48
22	170	14	18	24	37	49
22	175	14	18	25	37	49
23	180	14	19	25	37	50
24	185	14	19	25	37	50
24	190	14	19	25	38	50
25	195	14	19	25	38	51
26	200	14	19	26	38	51
26	205	14	19	26	39	51
27	210	14	20	26	39	52
28	215	14	20	26	39	52
29	220	14	20	26	39	52
29	225	14	20	27	40	53
30	230	14	20	27	40	53
31	235	14	20	27	40	53
31	240	14	21	27	40	53
32	245	14	21	27	40	53
33	250	14	21	27	40	54
33	255	14	21	27	41	54
34	260	14	21	28	41	54
34	265	15	21	28	41	54
35	270	15	21	28	41	54
36	275	—	21	28	41	54
36	280	—	21	28	41	55
37	285	—	22	28	41	55

NOTE: Figures are accurate at time of publication. Maximum critical temperatures for fully loaded structural steel members are normally accepted at 550°C for four sided column protection and at 620°C for three sided beam protection as a support to composite concrete floors.

For thickness calculations on hollow sections, cellular beams, castellated sections, composite floors, upgrading of concrete slabs and more complex structural situations, please consult Promat.

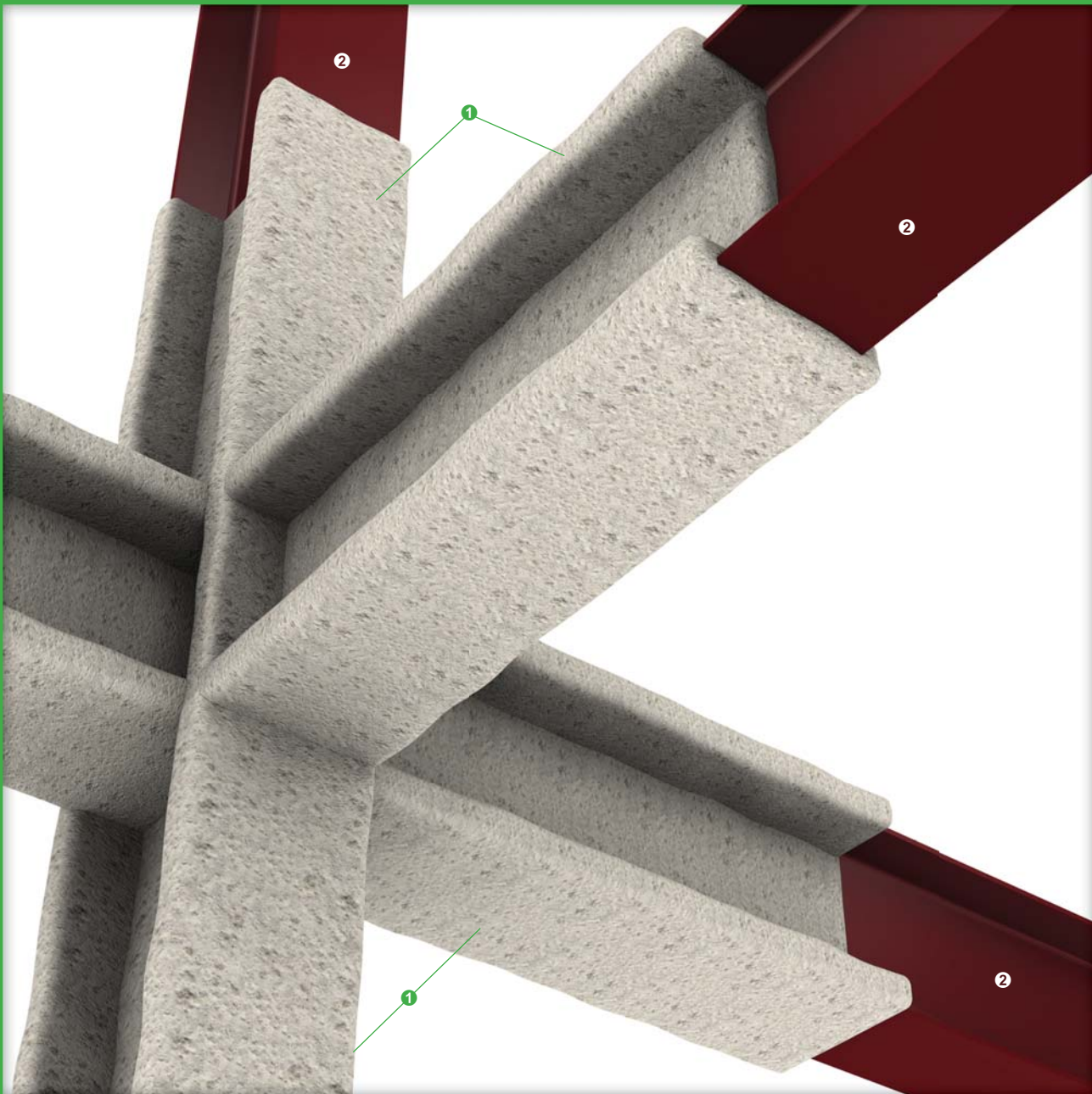

Up to 240/-/- or 180/-/- fire resistance in accordance with the requirements of BS 476: Part 21: 1987, AS 1530: Part 4: 2005 and/or ASTM E119: 2007*

- ① Spray, float or roller applied Cafco FENDOLITE® MII vermiculite and Portland cement based wet mix, thickness in accordance with the Hp/A Ratio tables on pages 59 to 61

For finishing, trowel applied with Cafco FENDOLITE® TG vermiculite and Portland cement based wet mix

Where necessary, spray, brush or roller applied CAFCO® TOPCOAT 200 acrylic polymer coating as a top coat sealer for external applications and use in moisture laden conditions or wet areas

- ② All structural steel surfaces to receive Cafco FENDOLITE® MII to be primed with compatible primer
All primed surfaces to be coated with CAFCO® PSK 101 sealer as keycoat prior to the application of Cafco FENDOLITE® MII

* Please consult Promat for application in accordance with the requirements of ASTM E119: 2007

Hp/A Ratio Table 1 Up to 240/-/- fire resistance in accordance with the requirements of **BS 476: Part 21: 1987** (report no. BRE CC 270878) for four sided 'I' section of structural steel beam protection at critical temperature of 550°C

Hp/A	Caico FENDOLITE® MII coating thickness when cured (mm)					
	30 minutes	60 minutes	90 minutes	120 minutes	180 minutes	240 minutes
30	8	8	9	11	17	23
40	8	8	10	14	21	28
50	8	8	12	16	24	32
60	8	9	13	18	27	36
70	8	9	14	19	29	39
80	8	10	15	21	31	42
90	8	11	16	22	33	45
100	8	11	17	23	35	47
110	8	12	18	24	36	49
120	8	12	18	25	38	51
130	8	12	19	26	39	52
140	8	13	20	26	40	54
150	8	13	20	27	41	55
160	8	13	20	28	42	56
170	8	14	21	28	43	58
180	8	14	21	29	44	—
190	8	14	22	29	44	—
200	8	14	22	30	45	—
210	8	14	22	30	46	—
220	8	15	22	30	46	—
230	8	15	23	31	47	—
240	8	15	23	31	47	—
250	8	15	23	31	48	—
260	8	15	23	32	48	—
270	8	15	24	32	49	—
280	8	15	24	32	49	—
290	8	16	24	33	49	—
300	8	16	24	33	50	—
310	8	16	24	33	50	—
320	8	16	25	33	51	—
330	8	16	25	33	51	—

NOTE: Figures are accurate at time of publication. Maximum critical temperatures for fully loaded structural steel members are normally accepted at 550°C for four sided column protection and at 620°C for three sided beam protection as a support to composite concrete floors.

Hp/A Ratio Table 2 Up to 240/-/- fire resistance in accordance with the requirements of **BS 476: Part 21: 1987** (report no. BRE CC 270878) for **three sided 'I' section of structural steel beam protection (where the beam forms part of a composite action concrete of the floor slab) at critical temperature of 620°C**

Hp/A	Cafco FENDOLITE® MII coating thickness when cured (mm)					
	30 minutes	60 minutes	90 minutes	120 minutes	180 minutes	240 minutes
30	8	8	8	9	14	19
40	8	8	8	11	17	23
50	8	8	9	13	20	27
60	8	8	11	14	22	30
70	8	8	12	16	25	33
80	8	8	12	17	27	36
90	8	8	13	18	28	39
100	8	9	14	19	30	41
110	8	9	15	20	32	43
120	8	9	15	21	33	45
130	8	10	16	22	34	46
140	8	10	16	23	35	48
150	8	10	17	23	36	49
160	8	11	17	24	37	51
170	8	11	18	25	38	52
180	8	11	18	25	39	53
190	8	11	18	26	40	54
200	8	12	19	26	40	55
210	8	12	19	26	41	56
220	8	12	19	27	42	57
230	8	12	20	27	42	58
240	8	12	20	28	43	58
250	8	12	20	28	43	—
260	8	13	20	28	44	—
270	8	13	21	29	44	—
280	8	13	21	29	45	—
290	8	13	21	29	45	—
300	8	13	21	29	46	—
310	8	13	21	30	46	—
320	8	13	22	30	46	—
330	8	13	22	30	47	—

NOTE: Figures are accurate at time of publication. Maximum critical temperatures for fully loaded structural steel members are normally accepted at 550°C for four sided column protection and at 620°C for three sided beam protection as a support to composite concrete floors.

Hp/A Ratio Table 3 Up to 180/-/- fire resistance in accordance with the requirements of **AS 1530: Part 4: 2005** (report no. BRANZ FAR 3541) for **four sided 'I' section of structural steel column protection at critical temperature of 550°C**

Hp/A	Cafco FENDOLITE® MII coating thickness when cured (mm)			
	60 minutes	90 minutes	120 minutes	180 minutes
90	13	17	23	41
100	13	17	23	41
110	13	17	23	41
120	13	17	24	41
130	13	18	25	41
140	13	19	26	41
150	13	19	26	41
160	13	20	27	42
170	13	20	28	42
180	13	21	28	43
190	14	21	29	44
200	14	22	29	44
210	14	22	30	45
220	15	22	30	46
230	15	23	30	46
240	15	23	31	47
250	15	23	31	—
260	15	23	31	—
270	16	24	32	—
280	16	24	32	—
290	16	24	32	—
	60 minutes	90 minutes	120 minutes	180 minutes

Hp/A Ratio Table 4 Up to 180/-/- fire resistance in accordance with the requirements of **AS 1530: Part 4: 2005** (report no. BRANZ FAR 3541) for **three sided 'I' section of structural steel beam protection (where the beam forms part of a composite action concrete of the floor slab) at critical temperature of 620°C**

Hp/A	Cafco FENDOLITE® MII coating thickness when cured (mm)			
	60 minutes	90 minutes	120 minutes	180 minutes
90	11	16	19	34
100	11	16	19	34
110	11	16	19	34
120	11	16	20	34
130	11	16	21	34
140	11	16	22	35
150	11	16	23	36
160	11	17	24	37
170	11	17	24	38
180	11	18	25	39
190	11	18	26	40
200	12	19	26	40
210	12	19	26	41
220	12	20	27	42
230	13	20	27	42
240	13	20	28	43
250	13	21	28	43
260	13	21	28	44
270	13	21	29	—
280	14	21	29	—
290	14	22	29	—
	60 minutes	90 minutes	120 minutes	180 minutes

NOTE: Figures are accurate at time of publication. Maximum critical temperatures for fully loaded structural steel members are normally accepted at 550°C for four sided column protection and at 620°C for three sided beam protection as a support to composite concrete floors.

For thickness calculations on hollow sections, cellular beams, castellated sections, composite floors, upgrading of concrete slabs and more complex structural situations, please consult Promat.

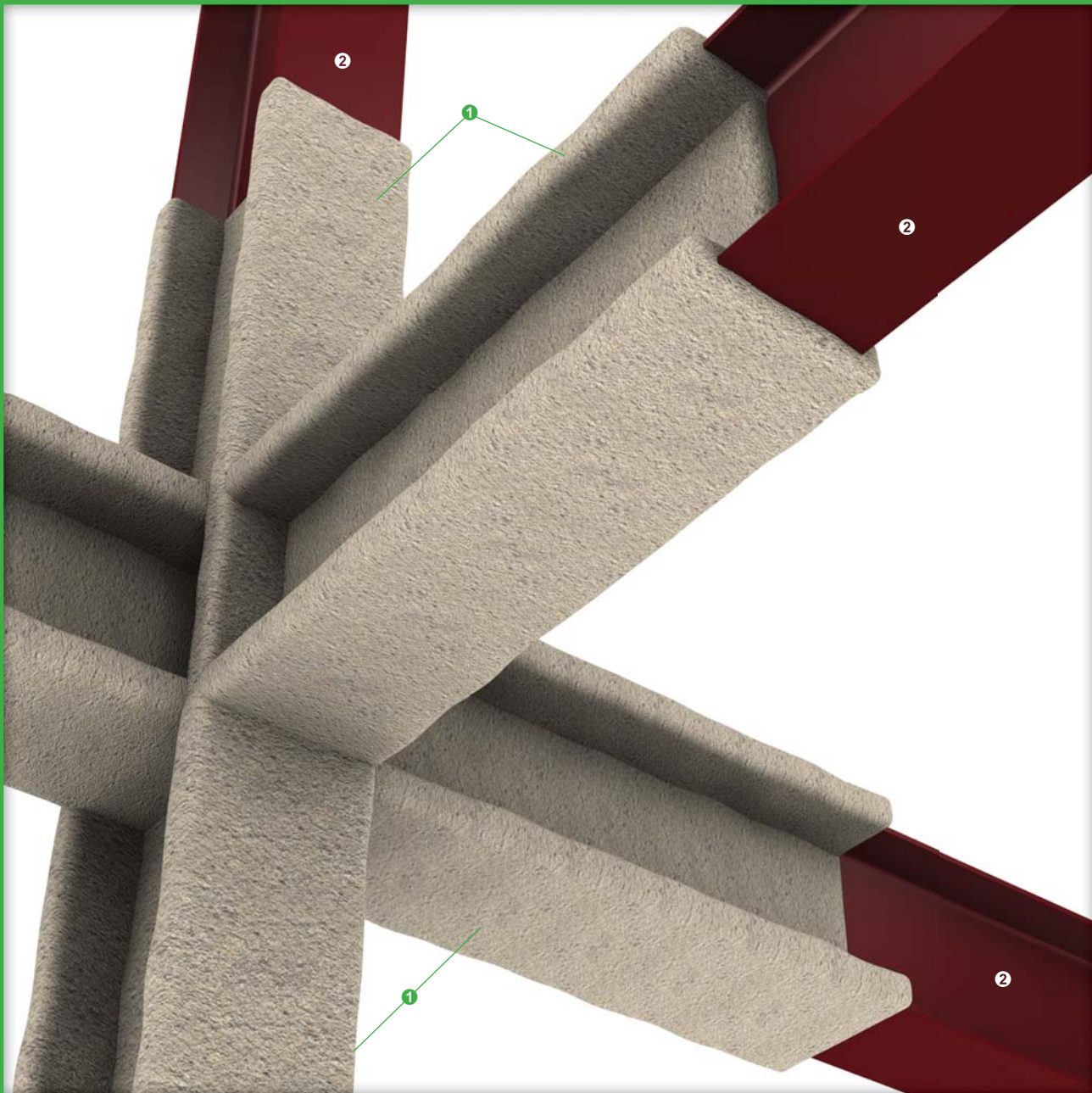

Up to 240/- fire resistance in accordance with the requirements of BS 476: Part 21: 1987, AS 1530: Part 4: 2005 and ASTM E119: 2007*

- ① Spray applied Cafco MANDOLITE® CP2 vermiculite and Portland cement based wet mix, thickness in accordance with the Hp/A Ratio tables on page 63

Where necessary, spray, brush or roller applied CAFCO® TOPCOAT 200 acrylic polymer coating as a top coat sealer for internal or sheltered external applications and use in moisture laden conditions or wet areas

- ② Application to unprimed and incompatible primed surfaces. All incompatible primers to be coated with CAFCO® PSK 101 sealer prior to the application of Cafco MANDOLITE® CP2

Spray, brush or roller applied with CAFCO® SC125 water based synthetic latex OR spray applied with CAFCO® SBR Bonding Latex (styrene butadiene latex adhesive) as a keycoat prior to applying the Cafco MANDOLITE® CP2

Mesh reinforcement may be required on the following conditions:

- There is no re-entrant detail on the structural steel substrate
- The structural steel substrate is subject to vibration
- Dimension of an 'I' or 'H' structural steel section exceeds 650mm between flanges and/or exceeds 325mm across flanges
- Diameter of a circular structural steel section exceeds 325mm
- Diameter of a single face hollow structural steel section exceeds 325mm

* Please consult Promat for application in accordance with the requirements of ASTM E119: 2007

Hp/A Ratio Table 1 Up to 240/-/- fire resistance in accordance with the requirements of **BS 476: Part 21: 1987** (report no. WF 198046) for **four sided universal structural steel column and beam protection at critical temperature of 550°C**

Hp/A	Cafco MANDOLITE® CP2 coating thickness when cured (mm)					
30	8	8	10	13	18	24
40	8	9	12	15	22	29
50	8	10	14	17	25	32
60	8	11	15	19	27	36
70	8	11	16	20	29	38
80	8	12	17	21	31	40
90	8	13	18	23	32	42
100	8	13	18	23	34	44
110	8	14	19	24	35	45
120	9	14	19	25	36	47
130	9	14	20	25	37	48
140	9	15	20	26	37	49
150	9	15	21	26	38	50
160	9	15	21	27	39	51
170	9	15	21	27	39	51
180	10	16	22	28	40	52
190	10	16	22	28	40	53
200	10	16	22	28	41	53
210	10	16	22	29	41	54
220	10	16	23	29	42	54
230	10	16	23	29	42	55
240	10	17	23	29	42	55
250	10	17	23	30	43	56
260	10	17	23	30	43	56
270	10	17	23	30	43	56
280	10	17	24	30	43	57
290	10	17	24	30	44	57
300	10	17	24	31	44	57
310	11	17	24	31	44	58
	30 minutes	60 minutes	90 minutes	120 minutes	180 minutes	240 minutes

Hp/A Ratio Table 2 Up to 240/-/- fire resistance in accordance with the requirements of **BS 476: Part 21: 1987** (report no. WF 198046) for **three sided 'I' section of structural steel beam protection (where the beam forms part of a composite action concrete of the floor slab) at critical temperature of 620°C**

Hp/A	Cafco MANDOLITE® CP2 coating thickness when cured (mm)					
30	8	8	8	11	15	20
40	8	8	10	13	19	24
50	8	8	11	15	21	28
60	8	9	12	16	23	31
70	8	10	13	17	25	33
80	8	10	14	19	27	35
90	8	11	15	20	28	37
100	8	11	16	20	30	39
110	8	12	16	21	31	40
120	8	12	17	22	32	42
130	8	12	17	22	33	43
140	8	13	18	23	33	44
150	8	13	18	24	34	45
160	8	13	19	24	35	46
170	8	13	19	24	35	46
180	8	14	19	25	36	47
190	8	14	19	25	37	48
200	8	14	20	25	37	49
210	8	14	20	26	37	49
220	8	14	20	26	38	50
230	8	14	20	26	38	50
240	8	14	21	27	39	51
250	9	15	21	27	39	51
260	9	15	21	27	39	51
270	9	15	21	27	40	52
280	9	15	21	27	40	52
290	9	15	21	28	40	53
300	9	15	21	28	40	53
310	9	15	22	28	41	53
	30 minutes	60 minutes	90 minutes	120 minutes	180 minutes	240 minutes

NOTE: Figures are accurate at time of publication. Maximum critical temperatures for fully loaded structural steel members are normally accepted at 550°C for four sided column protection and at 620°C for three sided beam protection as a support to composite concrete floors.

For thickness calculations on hollow sections, cellular beams, castellated sections, composite floors, upgrading of concrete slabs and more complex structural situations, please consult Promat.

The following is a standard Architectural Specification for structural steel column and beam protection using CAFCO® 300, Cafco FENDOLITE® MII or Cafco MANDOLITE® CP2⁽¹⁾. Please note that CAFCO® 300, Cafco FENDOLITE® MII or Cafco MANDOLITE® CP2⁽¹⁾ should be installed by a trained or approved applicator using appropriate and recommended equipment. The end user must determine the suitability of any particular design to meet the performance requirements of any application before undertaking any work. If in doubt, please first obtain advice from Promat.

The installation methods described herein are suitable for steel sections up to 686mm deep and 325mm wide. For larger section, please consult Promat.

Fire Exposure & Area of Application

Exposed faces of steelwork internal to building, for up to 180 or 240 ⁽²⁾ minute fire resistance in accordance with the requirements of BS 476: Part 21: 1987, AS 1530: Part 4: 2005 or ASTM E119: 2007.⁽³⁾

Location

⁽⁴⁾

Type of Construction

_____ minute⁽⁵⁾ fire resistance to CAFCO® 300, Cafco FENDOLITE® MII or Cafco MANDOLITE® CP2⁽¹⁾ one sided, two sided, three sided or four sided coating of structural steel columns and beams.

Spray Materials

CAFCO® 300 in 20kg bags, Cafco FENDOLITE® MII in 20kg bags or Cafco MANDOLITE® CP2 in 12.5kg/15kg bags⁽⁶⁾ as supplied by licensed manufacturers of Promat International (Asia Pacific) Ltd.

Surface Preparation

The substrate to be coated should be clean, dry and free from dust, or any other condition preventing good adhesion.

Method of Application

Pre mix CAFCO® 300, Cafco FENDOLITE® MII or Cafco MANDOLITE® CP2⁽¹⁾ with water in suitable type of mixer and apply onto the surface of substrate by direct spraying. Material-water mixing ratio should be applied strictly in accordance with Promat's recommendations by a trained and approved applicator.

The application of CAFCO® 300, Cafco FENDOLITE® MII or Cafco MANDOLITE® CP2⁽¹⁾ is recommended by using a suitable spray head with adequate capacity of air compressor.

Follow-on Trades

Surface of coating materials to be finished off smoothly or with suitable top coat⁽⁷⁾ in accordance with manufacturer's recommendations.

NOTE:

- ⁽¹⁾, ⁽²⁾, ⁽³⁾, ⁽⁶⁾, ⁽⁷⁾ delete as appropriate.
- ⁽⁴⁾ insert location, e.g. "beams and columns to offices interior", or provide steelwork drawing reference.
- ⁽⁵⁾ insert required fire resistance level (not exceeding 240 minutes for BS or AS and not exceeding 180 minutes for ASTM).

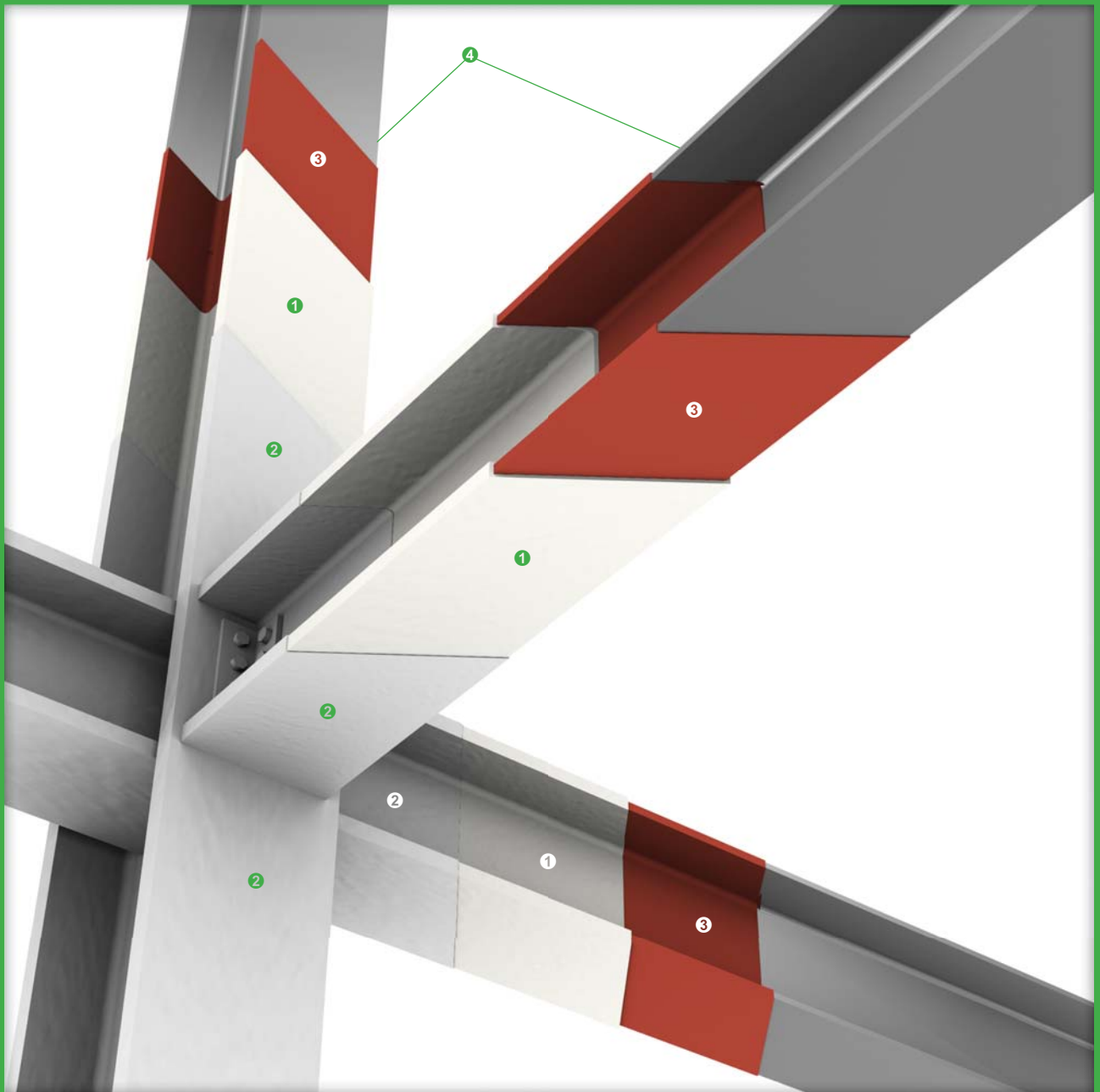

Up to 90/-/- or 120/-/- fire resistance in accordance with the requirements of BS 476: Part 21: 1987 and/or AS 1530: Part 4: 2005, and up to 180/-/- fire resistance in accordance with the requirements of ASTM E119: 2007*

- ① Spray, brush or roller applied Cafco SPRAYFILM® WB3 water based intumescent coating, thickness in accordance with the Hp/A Ratio tables on pages 66 to 72
- ② Spray, brush or roller applied CAFCO® TOPCOAT 200 acrylic polymer coating as a top coat sealer for humid or external applications and use in moisture laden conditions or wet areas
- ③ Primer approved by Promat
Please consult Promat and refer to application documents for the approved range of primers and top seals.
- ④ Structural steel column and beam. Clean, dry and free from dust, oil, loose mill scale or rust and any other condition preventing good adhesion AND blast cleaned in accordance with the requirements of AS 1627: Part 4 and SA 2.5 (ISO 8501-1: 1998) prior to applying the primer

* Please consult Promat for application in accordance with the requirements of ASTM E119: 2007

Hp/A Ratio Table 1 Up to 120/-/- fire resistance in accordance with the requirements of **BS 476: Part 21: 1987** (report no. WF 176738A) for four sided 'H' section of structural steel column protection at critical temperature of 550°C

Hp/A	Caico SPRAYFILM® WB3 coating thickness when cured / dry film thickness (mm)			
Up to 45	0.23	0.60	1.00	1.50
46-50	0.23	0.60	1.00	1.50
51-55	0.23	0.60	1.00	1.50
56-60	0.23	0.60	1.00	1.50
61-65	0.23	0.60	1.00	1.50
66-70	0.23	0.60	1.00	1.75
71-75	0.23	0.60	1.00	2.00
76-80	0.23	0.60	1.00	2.07
81-85	0.23	0.60	1.00	2.14
86-90	0.23	0.60	1.01	2.21
91-95	0.23	0.60	1.10	2.29
96-100	0.23	0.60	1.19	2.36
101-105	0.23	0.60	1.28	2.43
106-110	0.23	0.60	1.36	2.50
111-115	0.23	0.60	1.45	2.57
116-120	0.23	0.60	1.53	2.64
121-125	0.23	0.66	1.61	2.71
126-130	0.23	0.71	1.69	2.79
131-135	0.23	0.75	1.77	2.86
136-140	0.23	0.80	1.85	2.93
141-145	0.23	0.85	1.94	3.00
146-150	0.23	0.87	2.02	3.19
151-155	0.23	0.88	2.05	3.37
156-160	0.24	0.89	2.10	3.56
161-165	0.24	0.90	2.14	3.74
166-170	0.24	0.90	2.18	3.93
171-175	0.24	0.91	2.23	4.13
176-180	0.24	0.92	2.27	4.36
181-185	0.25	0.92	2.32	4.58
186-190	0.25	0.93	2.36	4.80
191-195	0.25	0.94	2.40	5.02
196-200	0.25	0.95	2.45	5.24
201-205	0.25	0.95	2.49	5.47
206-210	0.26	0.96	2.54	5.69
211-215	0.26	0.97	2.58	5.91
216-220	0.27	0.97	2.62	6.13
221-225	0.27	0.98	2.67	6.36
226-230	0.28	0.99	2.71	6.58
231-235	0.28	1.00	2.75	—
236-240	0.29	1.00	2.80	—
241-245	0.29	1.04	2.84	—
246-250	0.30	1.06	2.89	—
251-255	0.30	1.09	2.93	—
256-260	0.31	1.12	2.97	—
261-265	0.31	1.14	3.02	—
266-270	0.32	1.17	3.14	—
271-275	0.32	1.19	3.24	—
276-280	0.33	1.22	3.34	—
281-285	0.33	1.25	3.44	—
286-290	0.34	1.27	3.54	—
291-295	0.34	1.30	3.64	—
296-300	0.35	1.33	3.74	—
301-305	0.35	1.35	3.84	—
306-310	0.36	1.38	3.94	—
311-315	0.36	1.41	4.04	—
316-320	0.37	1.43	4.32	—
	30 minutes	60 minutes	90 minutes	120 minutes

NOTE: Figures are accurate at time of publication. Maximum critical temperatures for fully loaded structural steel members are normally accepted at 550°C for four sided column protection and at 620°C for three sided beam protection as a support to composite concrete floors.

Hp/A Ratio Table 2 Up to 120/-/- fire resistance in accordance with the requirements of **BS 476: Part 21: 1987** (report no. WF 176738A) for four sided 'I' section of structural steel beam protection at critical temperature of 550°C

Hp/A	Cafco SPRAYFILM® WB3 coating thickness when cured / dry film thickness (mm)			
Up to 45	0.23	0.57	1.20	1.20
46-50	0.23	0.57	1.20	1.20
51-55	0.23	0.57	1.20	1.22
56-60	0.23	0.57	1.20	1.33
61-65	0.23	0.57	1.20	1.44
66-70	0.23	0.57	1.20	1.53
71-75	0.23	0.57	1.20	1.82
76-80	0.23	0.57	1.20	2.05
81-85	0.23	0.57	1.20	2.09
86-90	0.23	0.57	1.20	2.17
91-95	0.23	0.57	1.20	2.25
96-100	0.23	0.57	1.20	2.33
101-105	0.23	0.57	1.21	2.41
106-110	0.23	0.57	1.27	2.48
111-115	0.23	0.57	1.33	2.56
116-120	0.23	0.57	1.38	2.64
121-125	0.23	0.57	1.44	2.72
126-130	0.23	0.63	1.50	2.80
131-135	0.23	0.68	1.63	2.88
136-140	0.23	0.74	1.76	2.95
141-145	0.23	0.79	1.89	3.03
146-150	0.23	0.85	2.03	3.24
151-155	0.23	0.88	2.06	3.41
156-160	0.23	0.90	2.12	3.59
161-165	0.23	0.91	2.17	3.76
166-170	0.23	0.93	2.22	3.93
171-175	0.24	0.95	2.27	4.13
176-180	0.24	0.96	2.33	4.36
181-185	0.24	0.98	2.38	4.58
186-190	0.24	1.00	2.43	4.80
191-195	0.24	1.01	2.48	5.02
196-200	0.25	1.03	2.54	5.24
201-205	0.25	1.05	2.59	5.47
206-210	0.25	1.07	2.64	5.69
211-215	0.25	1.08	2.69	5.91
216-220	0.26	1.10	2.75	6.13
221-225	0.27	1.12	2.80	6.36
226-230	0.27	1.13	2.85	6.58
231-235	0.28	1.15	2.91	—
236-240	0.29	1.17	2.96	—
241-245	0.30	1.18	3.01	—
246-250	0.30	1.20	3.18	—
251-255	0.31	1.22	3.32	—
256-260	0.32	1.25	3.42	—
261-265	0.32	1.27	3.62	—
266-270	0.33	1.30	3.76	—
271-275	0.34	1.32	3.91	—
276-280	0.35	1.34	4.06	—
281-285	0.35	1.37	4.18	—
286-290	0.36	1.39	4.30	—
291-295	0.37	1.41	4.43	—
296-300	0.38	1.44	4.56	—
301-305	0.38	1.46	4.68	—
306-310	0.39	1.49	4.81	—
311-315	0.40	1.51	4.94	—
316-320	0.40	1.54	5.06	—
	30 minutes	60 minutes	90 minutes	120 minutes

NOTE: Figures are accurate at time of publication. Maximum critical temperatures for fully loaded structural steel members are normally accepted at 550°C for four sided column protection and at 620°C for three sided beam protection as a support to composite concrete floors.

Hp/A Ratio Table 3 Up to 120/-/- fire resistance in accordance with the requirements of **BS 476: Part 21: 1987** (report no. WF 176738A) for **three sided 'I' section of structural steel beam protection (where the beam forms part of a composite action concrete of the floor slab) at critical temperature of 620°C**

Hp/A	Caico SPRAYFILM® WB3 coating thickness when cured / dry film thickness (mm)			
Up to 45	0.23	0.25	1.20	1.20
46-50	0.23	0.25	1.20	1.20
51-55	0.23	0.25	1.20	1.20
56-60	0.23	0.25	1.20	1.20
61-65	0.23	0.25	1.20	1.20
66-70	0.23	0.25	1.20	1.20
71-75	0.23	0.25	1.20	1.20
76-80	0.23	0.27	1.20	1.23
81-85	0.23	0.28	1.20	1.32
86-90	0.23	0.30	1.20	1.40
91-95	0.23	0.32	1.20	1.48
96-100	0.23	0.34	1.20	1.70
101-105	0.23	0.36	1.20	1.95
106-110	0.23	0.38	1.20	2.05
111-115	0.23	0.40	1.20	2.11
116-120	0.23	0.42	1.20	2.17
121-125	0.23	0.44	1.20	2.23
126-130	0.23	0.46	1.20	2.29
131-135	0.23	0.48	1.20	2.35
136-140	0.23	0.50	1.20	2.41
141-145	0.23	0.52	1.20	2.47
146-150	0.23	0.54	1.26	2.53
151-155	0.23	0.56	1.31	2.59
156-160	0.23	0.57	1.37	2.65
161-165	0.23	0.57	1.42	2.71
166-170	0.23	0.57	1.48	2.77
171-175	0.23	0.61	1.58	2.83
176-180	0.23	0.64	1.70	2.89
181-185	0.23	0.67	1.83	2.95
186-190	0.23	0.70	1.95	3.01
191-195	0.23	0.73	2.02	3.40
196-200	0.23	0.76	2.07	3.73
201-205	0.23	0.8	2.11	4.07
206-210	0.23	0.83	2.15	4.26
211-215	0.24	0.86	2.19	4.28
216-220	0.24	0.88	2.23	4.70
221-225	0.24	0.89	2.27	4.91
226-230	0.24	0.91	2.31	5.13
231-235	0.24	0.93	2.36	5.35
236-240	0.25	0.94	2.40	5.57
241-245	0.25	0.96	2.44	5.78
246-250	0.25	0.97	2.48	6.00
251-255	0.25	0.99	2.52	6.22
256-260	0.25	1.00	2.56	6.43
261-265	0.26	1.02	2.60	—
266-270	0.26	1.04	2.64	—
271-275	0.27	1.05	2.69	—
276-280	0.28	1.07	2.73	—
281-285	0.28	1.08	2.77	—
286-290	0.29	1.10	2.81	—
291-295	0.29	1.11	2.85	—
296-300	0.30	1.13	2.89	—
301-305	0.30	1.14	2.93	—
306-310	0.31	1.16	2.98	—
311-315	0.31	1.18	3.02	—
316-320	0.32	1.19	3.22	—
	30 minutes	60 minutes	90 minutes	120 minutes

NOTE: Figures are accurate at time of publication. Maximum critical temperatures for fully loaded structural steel members are normally accepted at 550°C for four sided column protection and at 620°C for three sided beam protection as a support to composite concrete floors.

Hp/A Ratio Table 4 Up to 120/-/ fire resistance in accordance with the requirements of **BS 476: Part 21: 1987** (report no. WF 176738B) for **four sided hollow section of structural steel column and beam protection at critical temperature of 550°C**

Hp/A	Cafco SPRAYFILM® WB3 coating thickness when cured / dry film thickness (mm)			
Up to 45	0.23	0.40	1.80	3.50
46-50	0.23	0.40	1.80	3.50
51-55	0.23	0.42	1.80	3.50
56-60	0.23	0.44	1.80	3.50
61-65	0.23	0.47	1.80	3.50
66-70	0.23	0.49	1.80	3.50
71-75	0.24	0.51	1.92	3.50
76-80	0.24	0.53	2.07	3.50
81-85	0.25	0.56	2.20	3.50
86-90	0.25	0.58	2.34	3.50
91-95	0.25	0.60	2.47	3.50
96-100	0.26	0.66	2.54	3.50
101-105	0.27	0.72	2.59	3.67
106-110	0.28	0.78	2.65	3.94
111-115	0.28	0.84	2.70	4.22
116-120	0.29	0.90	2.75	4.50
121-125	0.30	0.96	2.80	4.78
126-130	0.31	1.02	2.85	5.06
131-135	0.32	1.03	2.91	5.33
136-140	0.33	1.06	2.96	5.61
141-145	0.34	1.08	3.01	5.89
146-150	0.35	1.11	3.06	6.17
151-155	0.36	1.13	3.11	6.44
156-160	0.37	1.15	3.17	—
161-165	0.38	1.18	3.22	—
166-170	0.39	1.20	3.27	—
171-175	0.40	1.23	3.32	—
176-180	0.40	1.25	3.38	—
181-185	0.41	1.27	3.43	—
186-190	0.41	1.30	3.48	—
191-195	0.42	1.32	3.57	—
196-200	0.42	1.35	3.70	—
201-205	0.43	1.37	3.82	—
206-210	0.43	1.40	3.94	—
211-215	0.44	1.42	4.06	—
216-220	0.44	1.44	4.19	—
221-225	0.45	1.47	4.31	—
226-230	0.45	1.49	4.43	—
231-235	0.46	1.52	4.55	—
236-240	0.46	1.54	4.68	—
241-245	0.47	1.56	4.80	—
246-250	0.47	1.59	4.92	—
251-255	0.48	1.61	5.04	—
256-260	0.48	1.64	5.17	—
261-265	0.49	1.66	5.29	—
266-270	0.49	1.68	5.41	—
271-275	0.50	1.71	5.53	—
276-280	0.50	1.73	5.66	—
281-285	0.50	1.76	5.78	—
286-290	0.51	1.78	5.90	—
291-295	0.51	1.80	6.02	—
296-300	0.52	1.86	6.15	—
301-305	0.52	1.90	6.27	—
306-310	0.53	1.95	6.39	—
311-315	0.53	1.99	6.51	—
316-320	0.54	2.04	—	—
	30 minutes	60 minutes	90 minutes	120 minutes

NOTE: Figures are accurate at time of publication. Maximum critical temperatures for fully loaded structural steel members are normally accepted at 550°C for four sided column protection and at 620°C for three sided beam protection as a support to composite concrete floors.

Hp/A Ratio Table 5 Up to 120/-/- fire resistance in accordance with the requirements of **AS 1530: Part 4: 2005** (report no. WFRA 22465) for four sided 'H' section of structural steel column protection at critical temperature of 550°C

E (m ² /t)	Hp/A	Caico SPRAYFILM® WB3 coating thickness when cured / dry film thickness (mm)		
		60 minutes	90 minutes	120 minutes
6	47	0.7	0.7	1.0
7	55	0.7	0.7	1.2
8	63	0.7	0.7	1.4
9	71	0.8	0.8	1.5
10	79	0.8	0.9	1.7
11	86	0.8	1.0	1.9
12	94	0.9	1.0	2.1
13	102	0.9	1.1	2.2
14	110	0.9	1.2	2.4
15	118	1.0	1.3	2.6
16	126	1.0	1.4	2.8
17	133	1.0	1.5	3.0
18	141	1.1	1.6	3.2
16	126	1.1	1.7	3.5
20	157	1.1	1.8	3.7
21	165	1.2	1.9	3.9
22	173	1.2	2.0	4.2
23	181	1.3	2.2	4.4
24	188	1.3	2.3	4.7
25	196	1.3	2.4	4.9
26	204	1.4	2.5	5.2
27	212	1.4	2.7	—
28	220	1.4	2.8	—
29	228	1.5	2.9	—
30	236	1.5	3.1	—
31	243	1.5	3.2	—
32	251	2.3	3.4	—
33	259	3.2	3.5	—
		60 minutes	90 minutes	120 minutes

Hp/A Ratio Table 6 Up to 120/-/- fire resistance in accordance with the requirements of **AS 1530: Part 4: 2005** (report no. WFRA 22465) for four sided 'H' section of structural steel column protection (where the column forms part of a composite action concrete of the floor slab) at critical temperature of 620°C

E (m ² /t)	Hp/A	Caico SPRAYFILM® WB3 coating thickness when cured / dry film thickness (mm)		
		60 minutes	90 minutes	120 minutes
6	47	0.7	0.7	0.9
7	55	0.7	0.7	0.9
8	63	0.7	0.7	1.0
9	71	0.8	0.8	1.1
10	79	0.8	0.8	1.2
11	86	0.8	0.8	1.4
12	94	0.9	0.9	1.5
13	102	0.9	0.9	1.6
14	110	0.9	0.9	1.8
15	118	1.0	1.0	1.9
16	126	1.0	1.0	2.1
17	133	1.0	1.0	2.2
18	141	1.1	1.1	2.4
16	126	1.1	1.1	2.6
20	157	1.1	1.1	2.7
21	165	1.2	1.2	2.9
22	173	1.2	1.2	3.1
23	181	1.3	1.3	3.3
24	188	1.3	1.3	3.5
25	196	1.3	1.4	3.7
26	204	1.4	1.4	3.9
27	212	1.4	1.5	4.2
28	220	1.4	1.6	4.4
29	228	1.5	1.7	4.7
30	236	1.5	1.7	4.9
31	243	1.5	1.9	5.2
32	251	2.3	2.3	5.5
33	259	3.2	3.2	—
		60 minutes	90 minutes	120 minutes

Hp/A Ratio Table 7 Up to 120/-/ fire resistance in accordance with the requirements of **AS 1530: Part 4: 2005** (report no. WFRA 22465) for three sided 'I' section of structural steel beam protection at critical temperature of 550°C

E (m ² /t)	Hp/A	Cafco SPRAYFILM® WB3 coating thickness when cured / dry film thickness (mm)		
		60 minutes	90 minutes	120 minutes
9	71	0.8	1.2	1.9
10	79	0.8	1.2	1.9
11	86	0.8	1.2	1.9
12	94	0.8	1.2	1.9
13	102	0.8	1.3	1.9
14	110	0.8	1.4	1.9
15	118	0.8	1.4	2.1
16	126	0.8	1.5	2.2
17	133	0.8	1.6	2.3
18	141	0.9	1.7	2.5
19	149	0.9	1.8	2.7
20	157	0.9	1.9	2.9
21	165	0.9	2.0	3.1
22	173	0.9	2.1	3.3
23	181	0.9	2.2	3.5
24	188	1.0	2.4	3.8
25	196	1.0	2.5	4.1
26	204	1.0	2.7	4.4
27	212	1.1	2.9	4.7
28	220	1.1	3.1	—
29	228	1.1	3.3	—
30	236	1.2	3.6	—
31	243	1.2	3.9	—
32	251	1.3	4.2	—
33	259	1.3	4.6	—
34	267	1.4	5.1	—
35	275	1.5	5.7	—
36	283	1.6	—	—
		60 minutes	90 minutes	120 minutes

Hp/A Ratio Table 8 Up to 120/-/ fire resistance in accordance with the requirements of **AS 1530: Part 4: 2005** (report no. WFRA 22465) for three sided 'I' section of structural steel beam protection (where the beam forms part of a composite action concrete of the floor slab) at critical temperature of 620°C

E (m ² /t)	Hp/A	Cafco SPRAYFILM® WB3 coating thickness when cured / dry film thickness (mm)		
		60 minutes	90 minutes	120 minutes
9	71	—	1.0	1.4
10	79	—	1.0	1.4
11	86	—	1.0	1.4
12	94	—	1.0	1.4
13	102	—	1.1	1.5
14	110	—	1.1	1.6
15	118	—	1.2	1.7
16	126	—	1.2	1.9
17	133	—	1.3	2.0
18	141	—	1.4	2.1
19	149	—	1.4	2.2
20	157	—	1.5	3.4
21	165	—	1.6	2.6
22	173	—	1.7	2.7
23	181	—	1.7	2.9
24	188	—	1.9	3.2
25	196	—	2.0	3.4
26	204	—	2.1	3.7
27	212	—	2.2	4.0
28	220	—	2.4	4.3
29	228	—	2.6	4.7
30	236	—	2.8	5.2
31	243	—	3.1	—
32	251	—	3.3	—
33	259	—	3.7	—
34	267	—	4.1	—
35	275	—	4.7	—
36	283	—	—	—
		60 minutes	90 minutes	120 minutes

Hp/A Ratio Table 9 Up to 90/-/- fire resistance in accordance with the requirements of **AS 1530: Part 4: 2005** (report no. BWA 22645) for hollow section of structural steel column protection at critical temperature of 550°C

E (m ² /t)	Hp/A	Caico SPRAYFILM® WB3 coating thickness when cured / dry film thickness (mm)		
5	39	0.3	0.4	1.6
6	47	0.3	0.4	1.6
7	55	0.3	0.5	1.6
8	63	0.3	0.6	1.7
9	71	0.3	0.7	1.9
10	79	0.3	0.8	2.1
11	86	0.3	1.0	2.4
12	94	0.3	1.1	2.6
13	102	0.4	1.2	2.8
14	110	0.4	1.3	3.0
15	118	0.4	1.4	—
16	126	0.4	1.5	—
17	133	0.4	1.5	—
18	141	0.4	1.6	—
19	149	0.4	1.7	—
20	157	0.4	1.8	—
21	165	0.5	1.9	—
22	173	0.5	2.0	—
23	181	0.5	2.0	—
24	188	0.5	2.1	—
25	196	0.5	2.2	—
26	204	0.5	2.3	—
27	212	0.5	2.3	—
28	220	0.6	2.4	—
29	228	0.6	2.5	—
30	236	0.6	2.6	—
31	243	0.6	2.6	—
32	251	0.6	2.7	—
33	259	0.6	2.7	—
34	267	0.6	2.8	—
		30 minutes	60 minutes	90 minutes

NOTE: Figures are accurate at time of publication. Maximum critical temperatures for fully loaded structural steel members are normally accepted at 550°C for four sided column protection and at 620°C for three sided beam protection as a support to composite concrete floors.

For thickness calculations on, cellular beams, castellated sections, composite floors, upgrading of concrete slabs and more complex structural situations, please consult Promat.

The following is a standard Architectural Specification for structural steel column and beam protection using Cafco SPRAYFILM® WB3. Please note that Cafco SPRAYFILM® WB3 should be installed by a trained or approved applicator using appropriate and recommended equipment. The end user must determine the suitability of any particular design to meet the performance requirements of any application before undertaking any work. If in doubt, please first obtain advice from Promat.

The installation methods described herein are suitable for steel sections up to 686mm deep and 325mm wide. For larger section, please consult Promat.

Fire Exposure & Area of Application

Exposed faces of steelwork internal to building, for up to 90/120/180 ⁽¹⁾ minute fire resistance in accordance with the requirements of BS 476: Part 21: 1987, AS 1530: Part 4: 2005 or ASTM E119: 2007.⁽²⁾

Location

⁽³⁾

Type of Construction

_____ minute⁽⁴⁾ fire resistance to Cafco SPRAYFILM® WB3 one sided, two sided, three sided or four sided coating of structural steel columns and beams.

Spray Materials

Cafco SPRAYFILM® WB3 in 25kg pail containers as supplied by licensed manufacturers of Promat International (Asia Pacific) Ltd.

Surface Preparation

The substrate to be coated should be clean, dry and free from dust, or any other condition preventing good adhesion. When applied over a primer, please consult Promat for compatibility.

The substrate to be coated should be clean, dry and free from dust, or any other condition preventing good adhesion, as such priming is highly recommended. Please consult Promat and refer to application documents for the approved range of primers and top seals.

Method of Application

Cafco SPRAYFILM® WB3 is supplied ready for use in sealed containers and generally does not need to be diluted. The material should be thoroughly stirred with a rotar type mixer prior to application.

The application of Cafco SPRAYFILM® WB3 is recommended by using an airless spray pump.

Follow-on Trades

Surface of coating materials to be finished off smoothly or with suitable top coat⁽⁵⁾ in accordance with manufacturer's recommendations.

NOTE:

- ^{(1), (2), (5)} delete as appropriate.
- ⁽³⁾ insert location, e.g. "beams and columns to offices interior", or provide steelwork drawing reference.
- ⁽⁴⁾ insert required fire resistance level (not exceeding 120 minutes for BS or AS and not exceeding 180 minutes for ASTM).

For latest information of the Promat Asia Pacific organisation, please refer to www.promat-ap.com.

ASIA PACIFIC HEADQUARTERS

Promat International (Asia Pacific) Ltd.

Unit 19-02-01, Level 2 PNB Damansara
No.19 Lorong Dungun, Damansara Heights
50490 Kuala Lumpur
MALAYSIA
Tel: +60 (3) 2095 5111
Fax: +60 (3) 2095 6111
Email: info@promat-ap.com

AUSTRALIA

Promat Australia Pty. Ltd.

1 Scotland Road
Mile End South, SA 5031
Tel: 1800 PROMAT (776 628)
Fax: +61 (8) 8352 1014
Email: mail@promat.com.au

New South Wales Office

Promat Australia Pty. Ltd.

Unit 1, 175 Briens Road
Northmead, NSW 2152
Tel: 1800 PROMAT (776 628)
Fax: +61 (2) 9630 0258
Email: mail@promat.com.au

Victoria Office

Promat Australia Pty. Ltd.

Suite 205, 198 Harbour Esplanade
Docklands, VIC 3008
Tel: 1800 PROMAT (776 628)
Fax: 1800 334 598
Email: mail@promat.com.au

Queensland Office

Promat Australia Pty. Ltd.

1/68 Lisgar Street
Virginia, QLD 4014
Tel: 1800 011 376
Fax: 1800 334 598
Email: mail@promat.com.au

CHINA

Promat China Ltd.

Room 506, Block A, Qi Lin Plaza
13-35 Pan Fu Road
510180 Guangzhou
Tel: +86 (20) 8136 1167
Fax: +86 (20) 8136 1372
Email: info@promat.com.cn

Beijing Office

Promat North China

(Division of Promat China Ltd.)

Room 1507 Building 5, SOHO Xiandaicheng
No.88 Jianguo Road, Chaoyang District
100022 Beijing
Tel: +86 (10) 8589 1254
Fax: +86 (10) 8589 2904
Email: info@promat.com.cn

For Promat International and its worldwide group, see www.promat-international.com.

- The technical data provided in this publication is based on mean values prevalent at time of publication and is thus subject to fluctuation. It should not be regarded as a guarantee of system performance.
- All data contained herein conforms to and frequently surpasses generally accepted fire protection standards recognised by most professional fire science practitioners and regulatory authorities worldwide. The same general principle is equally applicable to all Promat products and systems. Promat has access to a considerable body of test authentication data and this can be provided on a complimentary basis upon request. It should be noted however that this publication replaces all previous editions in its entirety. Any form of reproduction by any means – manual, electronic, digital or otherwise – is strictly prohibited and subject to prior approval in writing from Promat. All rights related or connected to the Promat logo, Promat registered trademarks, featured illustrations, written information and technical reports in this publication are the sole, exclusive and copyright property of Promat and its legal partner companies.

HONG KONG

Promat International (Asia Pacific) Ltd.

Room 1010, C.C. Wu Building
302-308 Hennessy Road
Wanchai
Tel: +852 2836 3692
Fax: +852 2834 4313
Email: apromath@promat.com.hk

INDIA

Promat (Malaysia) Sdn. Bhd.

(India Representative Office)

610-611, Ansal Imperial Tower
C-Block, Community Centre
Naraina Vihar, Naraina
New Delhi 110028
Tel: +91 (11) 2577 8413
Fax: +91 (11) 2577 8414
Email: info-india@promat-asia.com

Bangalore Office

Promat (Malaysia) Sdn. Bhd.

(India Representative Office)

Cabin No. BC-10
Oculus Workspaces, No.66/1, 2nd Floor
Coles Road, Frazer Town
Bangalore 560005
Tel: +91 (80) 4031 4151
Fax: +91 (80) 4125 2135
Email: info-india@promat-asia.com

MALAYSIA

Promat (Malaysia) Sdn. Bhd.

Unit 19-02-01, Level 2 PNB Damansara
No.19 Lorong Dungun, Damansara Heights
50490 Kuala Lumpur
Tel: +60 (3) 2095 8555
Fax: +60 (3) 2095 2111
Email: info@promat.com.my

SINGAPORE

Promat Building System Pte. Ltd.

10 Science Park Road, #03-14 The Alpha
Singapore Science Park II
Singapore 117684
Tel: +65 6776 7635
Fax: +65 6776 7624
Email: info@promat.com.sg

SOUTH KOREA

Promat International (Asia Pacific) Ltd.

(Korea Branch Office)

Room 406, 811-2
Yeoksam-dong Gangnam-gu
Seoul 135080
Tel: +82 (70) 7794 8216
Email: apromath@promat.com.hk

Your local Promat supplier

