

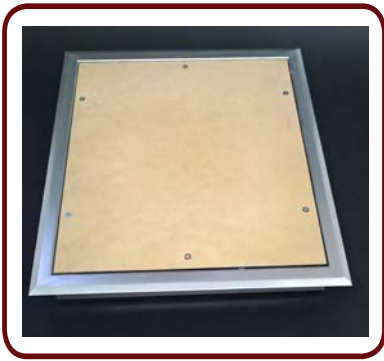

## 2 HOUR, SCREW FIXED, CEILING OR WALL ACCESS PANEL

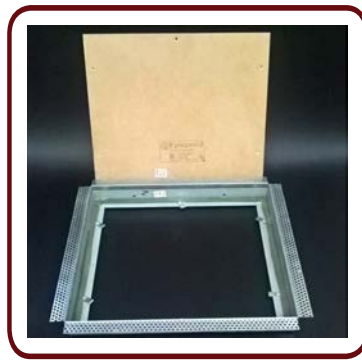

**FEATHERED FLANGE**



**SETTING BEAD**

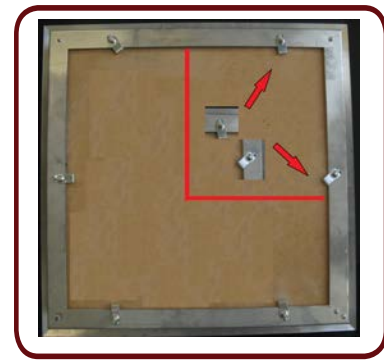

**THREADED SPEED NUTS**

### GENERAL

The PP - FYREPANEL / PROMAPANEL is a screw fixed fire rated access panel with a laminated MDF or ACP face designed to meet the requirements of the BCA with FRL's of - /240/120, - /180/120, & - /120/120.

### USES

The PP - FYREPANEL / PROMAPANEL is approved for installation in walls, shafts and ceilings of fire rated construction where integrity and insulation are required to be maintained to meet that of the building element requiring access through it. Example: An FRL 120/120/120 or - /120/120 wall.

### SIZES

**Maximum** size for masonry and light weight walls is 1500x1000mm.

**Maximum size for Lightweight Ceiling** applications is 1200x600mm.

**Standard sizes are:** 300x300, 400x400, 450x450, 500x500, 600x600 1000x600 & 1200x600mm

**Non-Standard** sizes available on request.

### FIRE TEST DATA

The Fyreguard PP - FYREPANEL / PROMAPANEL has been tested and assessed to AS1530.4 to provide FRL's up to -/240/120. Please contact your nearest Fyreguard office for further information.

### KEY FEATURES

- **Product fit for purpose to meet the requirements of NCC (BCA)**
- **Wall & Ceiling Application**
- **Flush Set or Feathered Flange**
- **Simple Installation**
- **Australian Made**
- **Non Standard sizes available**
- **Up to 4 Hours fire rating**

### SPECIFICATION

Fyreguard PP - FYREPANEL – Screw Fixed FRL -/120/120 fire rated access hatch. Wall or Ceiling Application. PH. 07 55934955

### INSTALLATION

Refer to following Pages of this data sheet for installation instructions or contact your nearest Fyreguard office for assistance.

### ARCHITECTURAL

Refer to following pages of this data sheet for dimensions of the hatch and architectural drawings of frame profile.

**NB: ALL FYREGUARD FIRE RATED ACCESS HATCHES ARE LABELED FOR EASE OF COMPLIANCE AND MAINTAINENCE INSPECTIONS. LABELING IS IN ACCORDANCE WITH FPA GOOD PRACTICE GUIDE AND AS4072.1**

NB: Fyreguard is not responsible if recipients of installation instructions, fire test reports or any relevant literature incorrectly interpret the contents or use products based on those interpretations.



## INSTALLATION INSTRUCTIONS

### 2 HOUR FIRE RATED SCREW FIXED ACCESS PANEL FOR LIGHTWEIGHT CEILINGS

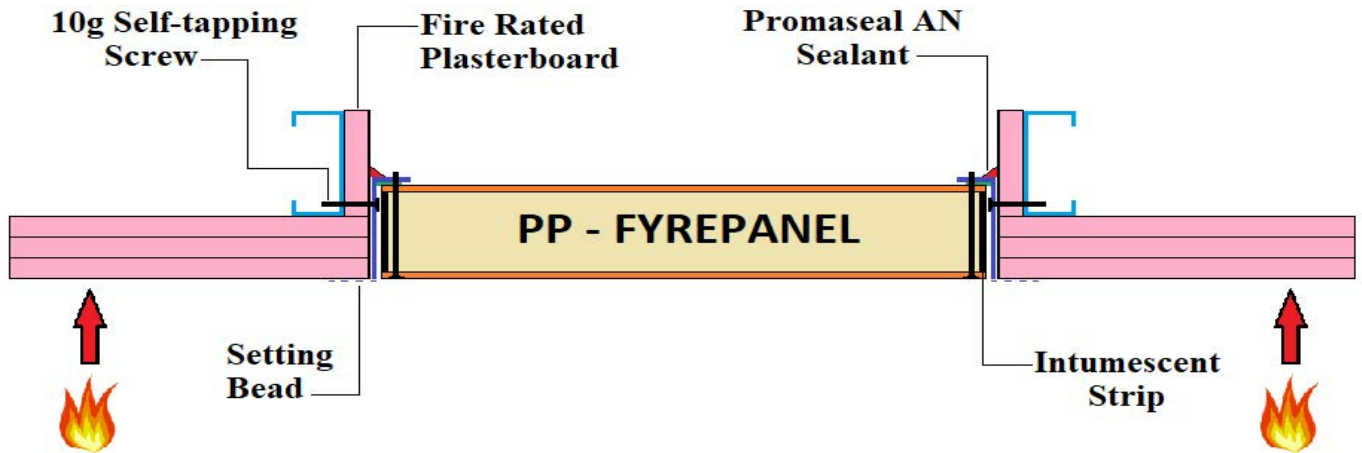

1. Mark out and cut opening in the ceiling.
2. Frame the opening with steel studs or trimmers. Line the studs or trimmers with fire rated board of the same thickness as the fire exposed face of the wall or ceiling.
3. Match access panel to the now trimmed and lined opening.
4. Open the hatch/panel and secure frame to the joists or trimmers with steel screws on all 4 sides of the hatch in the holes provided. NB: Ensure the frame is temporarily packed out before tightening screws or anchors to prevent the frame from distorting. The hatch/panel bolts will not line up with the nuts if distortion occurs. Ensure to remove temporary packers.
5. Frame the opening with steel studs or trimmers.
6. While the hatch/panel is open apply fire rated mastic sealant to any gaps between the access panel frame and the inside reveal of the opening.
7. Insert hatch/panel into frame ensuring the correct sides line up – refer to identification points on frame and hatch/panel. Engage all panel screws before fully tightening.

## ARCHITECTURAL DETAIL

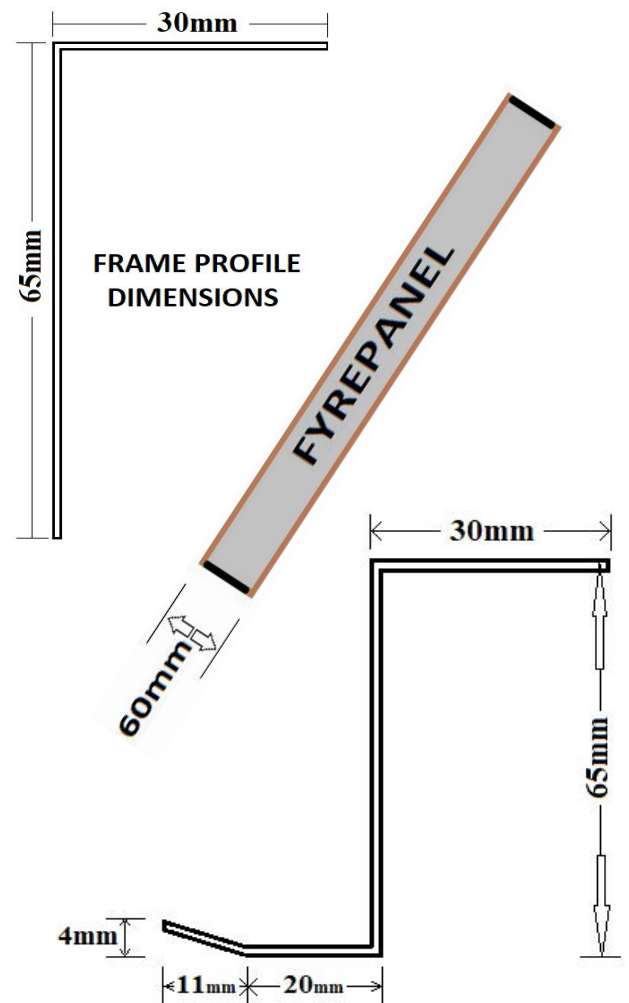

**NB: ALL FYREGUARD FIRE RATED ACCESS HATCHES ARE LABELED FOR EASE OF COMPLIANCE AND MAINTAINENCE INSPECTIONS. LABELING IS IN ACCORDANCE WITH FPAA GOOD PRACTICE GUIDE AND AS4072.1**

**FYREGUARD PP - FYRE PANEL FRL -/120/120**



## INSTALLATION INSTRUCTIONS

### 2 HOUR FIRE RATED SCREW FIXED ACCESS PANEL FOR LIGHTWEIGHT CEILINGS

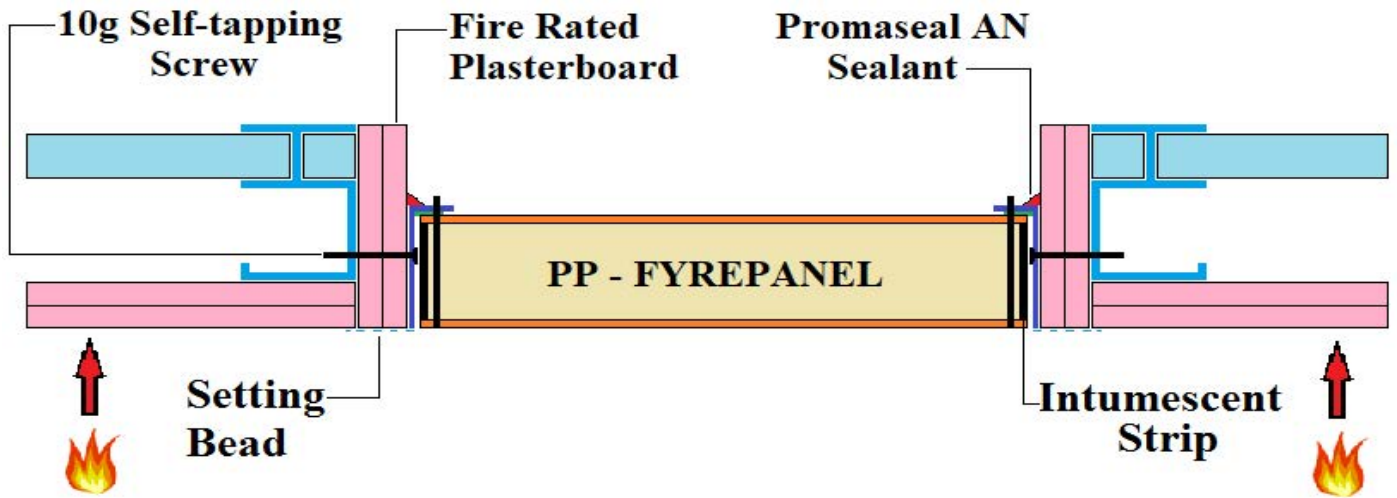

1. Mark out and cut opening in the ceiling.
2. Frame the opening with steel studs or trimmers. Line the studs or trimmers with fire rated board of the same thickness as the fire exposed face of the wall or ceiling.
3. Match access panel to the now trimmed and lined opening.
4. Open the hatch/panel and secure frame to the joists or trimmers with steel screws on all 4 sides of the hatch in the holes provided. NB: Ensure the frame is temporarily packed out before tightening screws or anchors to prevent the frame from distorting. The hatch/panel bolts will not line up with the nuts if distortion occurs. Ensure to remove temporary packers.
5. Frame the opening with steel studs or trimmers.
6. While the hatch/panel is open apply fire rated mastic sealant to any gaps between the access panel frame and the inside reveal of the opening.
7. Insert hatch/panel into frame ensuring the correct sides line up – refer to identification points on frame and hatch/panel. Engage all panel screws before fully tightening.

## ARCHITECTURAL DETAIL

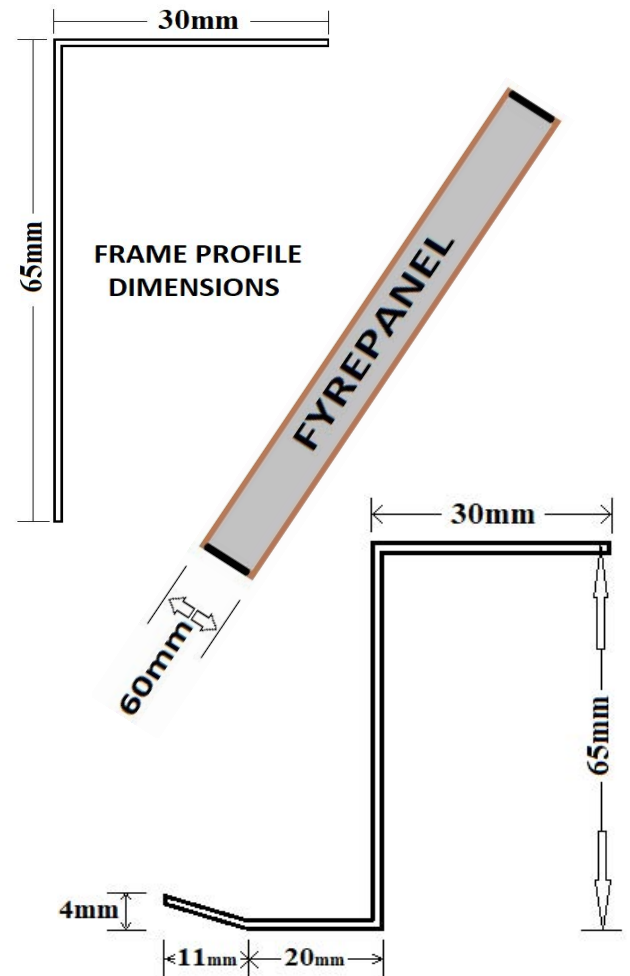

**NB: ALL FYREGUARD FIRE RATED ACCESS HATCHES ARE LABELED FOR EASE OF COMPLIANCE AND MAINTAINENCE INSPECTIONS. LABELING IS IN ACCORDANCE WITH FPAAGOOD PRACTICE GUIDE AND AS4072.1**

**FYREGUARD PP - FYRE PANEL FRL -/120/120**



## INSTALLATION INSTRUCTIONS

### 2 HOUR FIRE RATED SCREW FIXED ACCESS PANEL FOR LIGHTWEIGHT CEILINGS

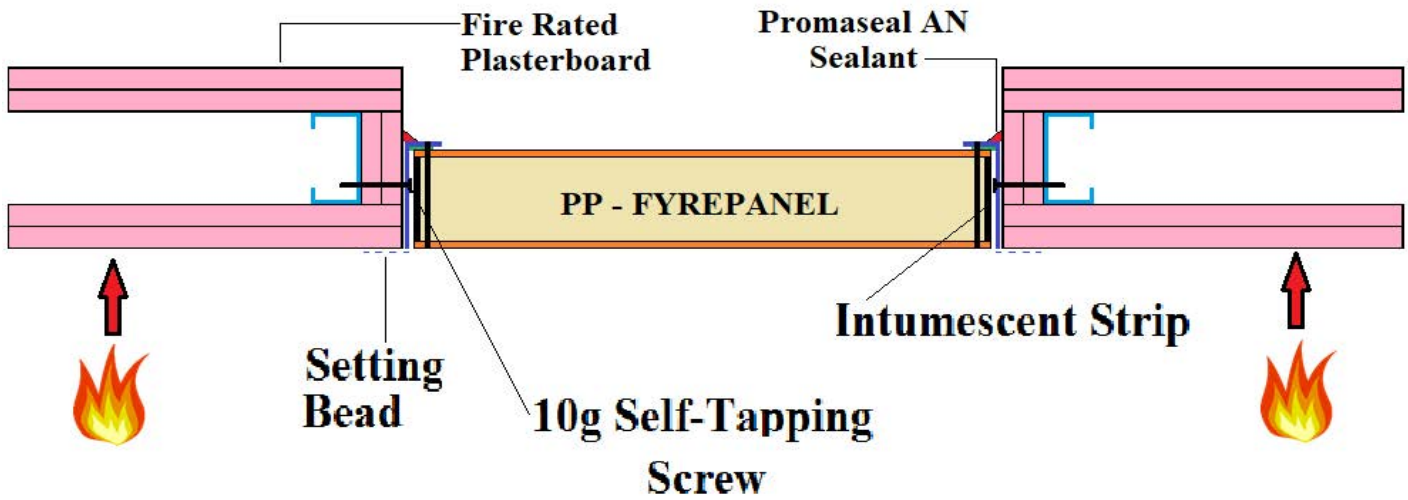

ACCESS HATCHES

1. Mark out and cut opening in the ceiling.
2. Frame the opening with steel studs or trimmers. Line the studs or trimmers with fire rated board of the same thickness as the fire exposed face of the wall or ceiling.
3. Match access panel to the now trimmed and lined opening.
4. Open the hatch/panel and secure frame to the joists or trimmers with steel screws on all 4 sides of the hatch in the holes provided. NB: Ensure the frame is temporarily packed out before tightening screws or anchors to prevent the frame from distorting. The hatch/panel bolts will not line up with the nuts if distortion occurs. Ensure to remove temporary packers.
5. Frame the opening with steel studs or trimmers.
6. While the hatch/panel is open apply fire rated mastic sealant to any gaps between the access panel frame and the inside reveal of the opening.
7. Insert hatch/panel into frame ensuring the correct sides line up – refer to identification points on frame and hatch/panel. Engage all panel screws before fully tightening.

## ARCHITECTURAL DETAIL

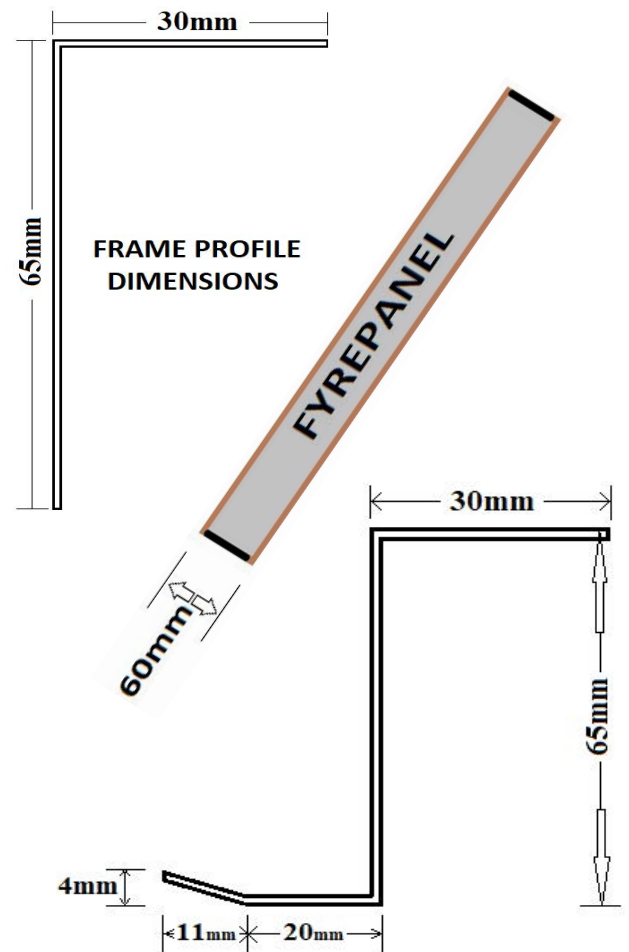

**NB: ALL FYREGUARD FIRE RATED ACCESS HATCHES ARE LABELED FOR EASE OF COMPLIANCE AND MAINTAINENCE INSPECTIONS. LABELING IS IN ACCORDANCE WITH FPA GOOD PRACTICE GUIDE AND AS4072.1**

**FYREGUARD PP - FYREPANEL FRL -/120/120**





## INSTALLATION INSTRUCTIONS

### 2 HOUR FIRE RATED SCREW FIXED ACCESS PANEL FOR MASONRY CEILINGS.

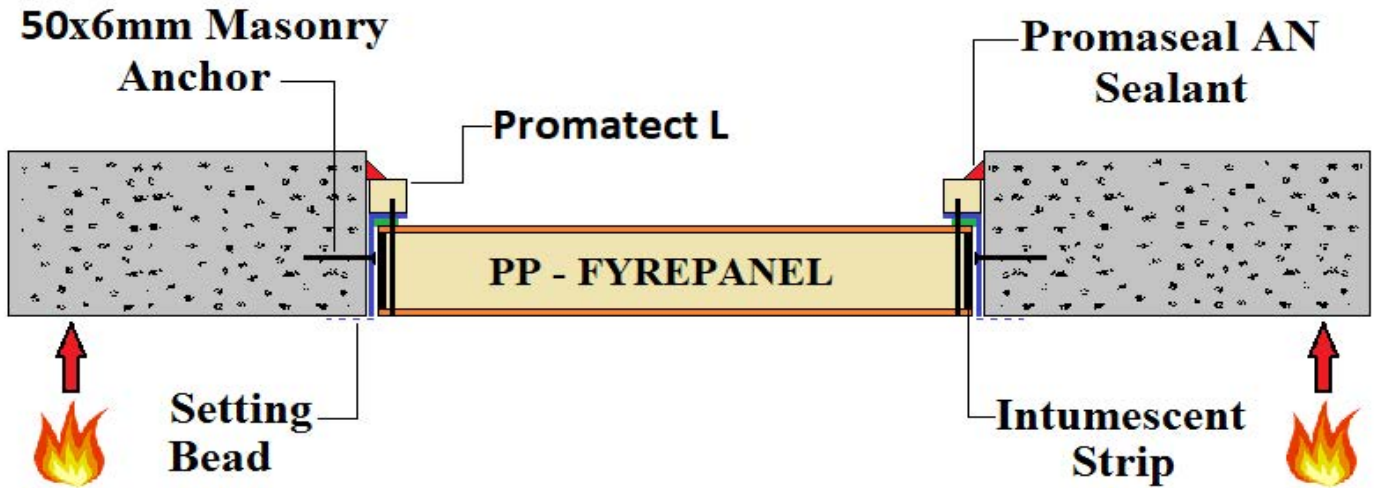

## ARCHITECTURAL DETAIL

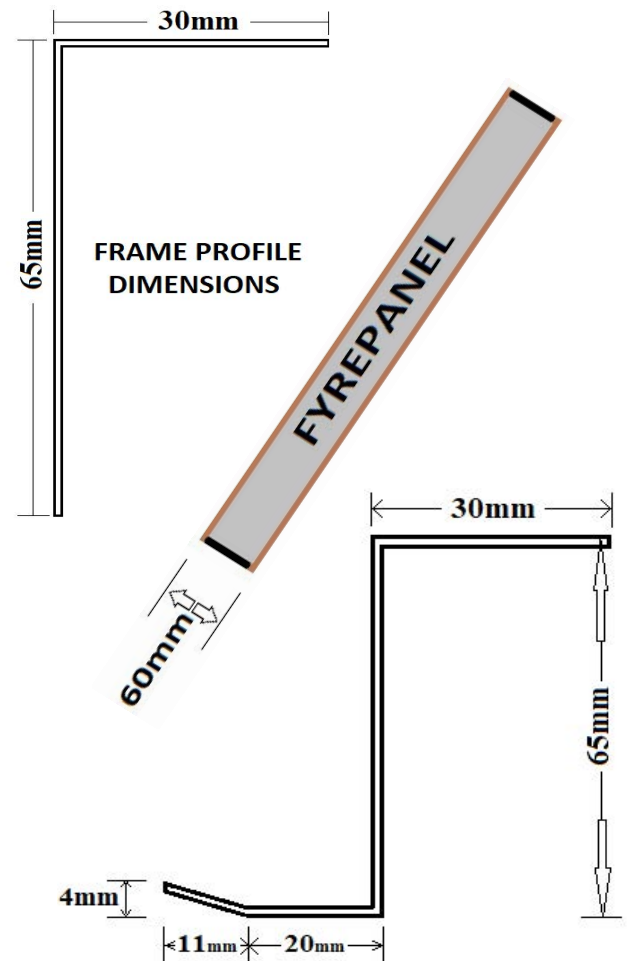

1. Mark out and cut opening in the ceiling.
2. Match access panel to the now trimmed and lined opening.
3. Open the hatch/panel and secure frame to the Masonry ceiling with M6 all steel masonry anchors, to all 4 sides of the hatch, using the predrilled holes provided.  
**NB:** Ensure the frame is temporarily packed out before tightening screws or anchors to prevent the frame from distorting. The hatch/panel bolts will not line up with the nuts if distortion occurs. Ensure to remove temporary packers.
4. While the hatch/panel is open apply fire rated mastic sealant to any gaps between the access panel frame and the inside reveal of the opening.
5. Insert hatch/panel into frame ensuring the correct sides line up – refer to identification points on frame and hatch/panel. Engage all panel screws before fully tightening.

**NB: ALL FYREGUARD FIRE RATED ACCESS HATCHES ARE LABELED FOR EASE OF COMPLIANCE AND MAINTAINENCE INSPECTIONS. LABELING IS IN ACCORDANCE WITH FPA GOOD PRACTICE GUIDE AND AS4072.1**

**FYREGUARD PP - FYREPANEL FRL -/120/120**



## INSTALLATION INSTRUCTIONS

### 2 HOUR FIRE RATED SCREW FIXED ACCESS PANELS FOR LIGHTWEIGHT WALLS

1. Mark out and cut opening in the wall.
2. Frame the opening with steel studs or trimmers. Line the studs or trimmers with fire rated board of the same thickness as the fire exposed face of the wall or ceiling.
3. Match access panel to the now trimmed and lined opening.
4. Open the hatch/panel and secure frame to the joists or trimmers with steel screws on all 4 sides of the hatch in the holes provided. NB: Ensure the frame is temporarily packed out before tightening screws or anchors to prevent the frame from distorting. The hatch/panel bolts will not line up with the nuts if distortion occurs. Ensure to remove temporary packers.
5. Frame the opening with steel studs or trimmers.
6. While the hatch/panel is open apply fire rated mastic sealant to any gaps between the access panel frame and the inside reveal of the opening.
7. Insert hatch/panel into frame ensuring the correct sides line up – refer to identification points on frame and hatch/panel. Engage all panel screws before fully tightening.

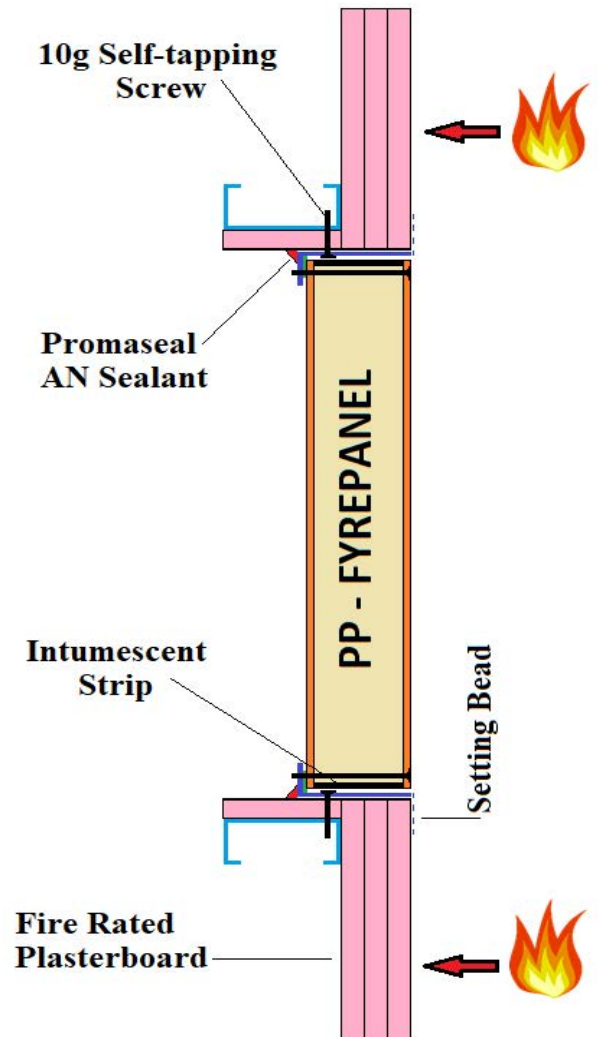

### ARCHITECTURAL DETAIL

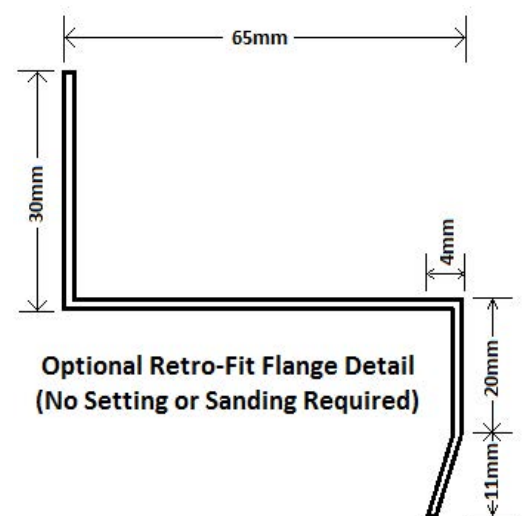
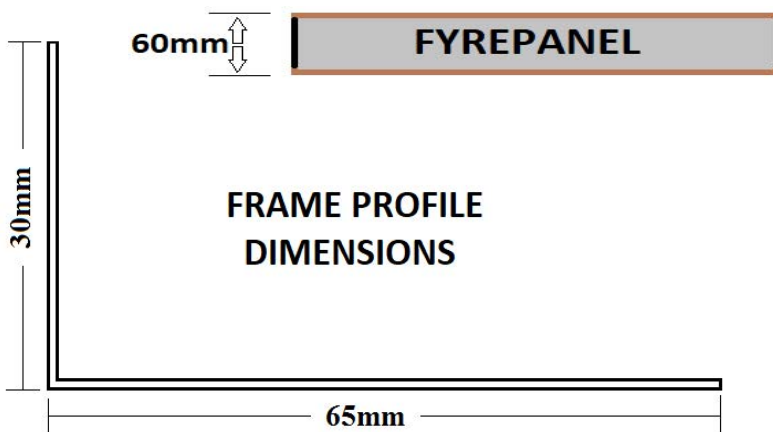

**NB: ALL FYREGUARD FIRE RATED ACCESS HATCHES ARE LABELED FOR EASE OF COMPLIANCE AND MAINTAINENCE INSPECTIONS. LABELING IS IN ACCORDANCE WITH FPAA GOOD PRACTICE GUIDE AND AS4072.1**



## INSTALLATION INSTRUCTIONS

### 2 HOUR FIRE RATED SCREW FIXED ACCESS PANELS FOR LIGHTWEIGHT WALLS

1. Mark out and cut opening in the wall.
2. Frame the opening with steel studs or trimmers. Line the studs or trimmers with fire rated board of the same thickness as the fire exposed face of the wall or ceiling.
3. Match access panel to the now trimmed and lined opening.
4. Open the hatch/panel and secure frame to the joists or trimmers with steel screws on all 4 sides of the hatch in the holes provided. NB: Ensure the frame is temporarily packed out before tightening screws or anchors to prevent the frame from distorting. The hatch/panel bolts will not line up with the nuts if distortion occurs. Ensure to remove temporary packers.
5. Frame the opening with steel studs or trimmers.
6. While the hatch/panel is open apply fire rated mastic sealant to any gaps between the access panel frame and the inside reveal of the opening.
7. Insert hatch/panel into frame ensuring the correct sides line up - refer to identification points on frame and hatch/panel. Engage all panel screws before fully tightening.

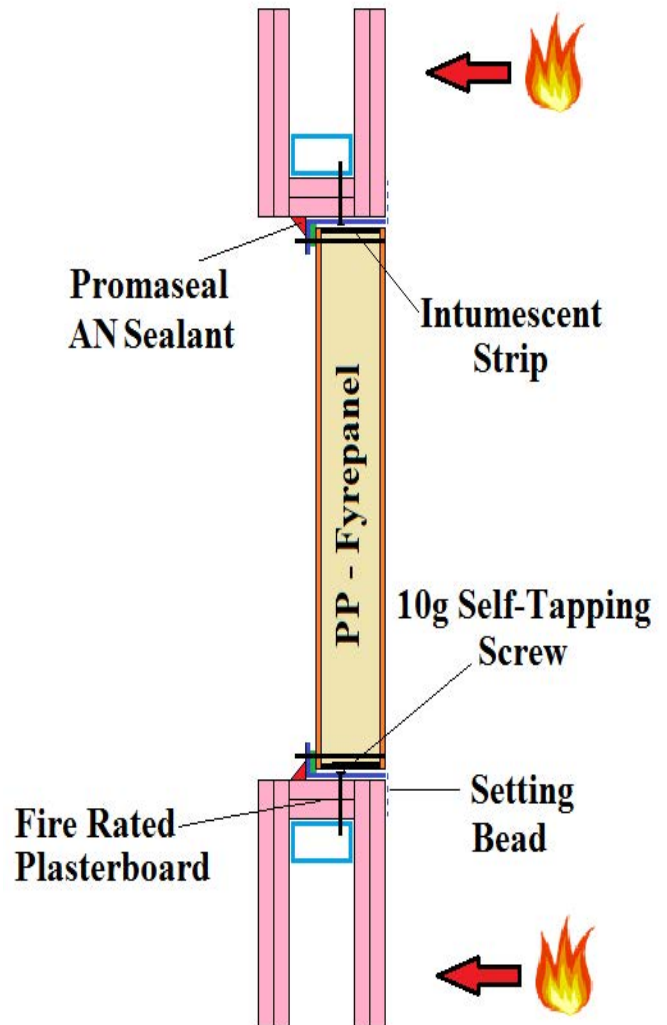

## ARCHITECTURAL DETAIL

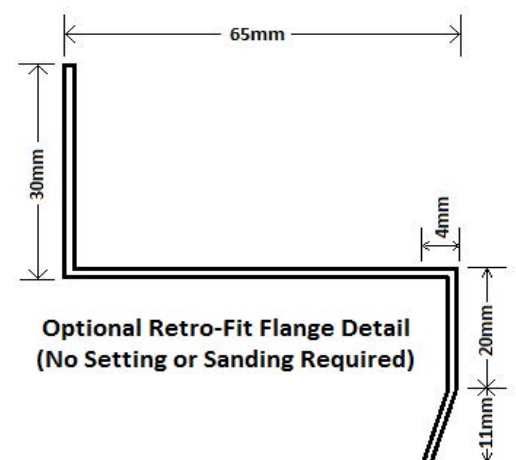
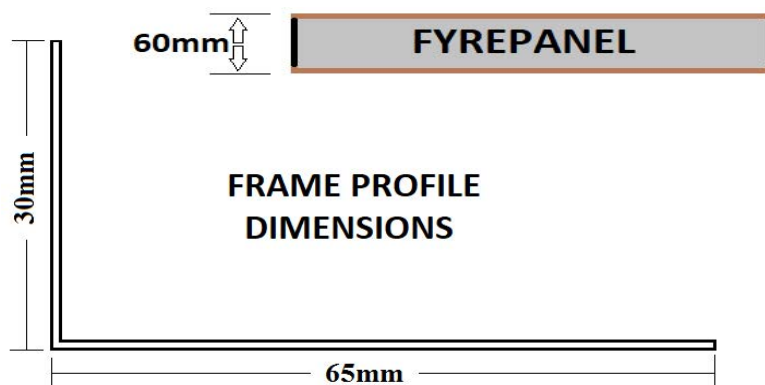

**NB: ALL FYREGUARD FIRE RATED ACCESS HATCHES ARE LABELED FOR EASE OF COMPLIANCE AND MAINTAINENCE INSPECTIONS. LABELING IS IN ACCORDANCE WITH FPA GOOD PRACTICE GUIDE AND AS4072.1**



## INSTALLATION INSTRUCTIONS

### 2 HOUR FIRE RATED SCREW FIXED ACCESS PANELS FOR LIGHTWEIGHT WALLS

1. Mark out and cut opening in the wall.
2. Frame the opening with steel studs or trimmers. Line the studs or trimmers with fire rated board of the same thickness as the fire exposed face of the wall or ceiling.
3. Match access panel to the now trimmed and lined opening.
4. Open the hatch/panel and secure frame to the joists or trimmers with steel screws on all 4 sides of the hatch in the holes provided. NB: Ensure the frame is temporarily packed out before tightening screws or anchors to prevent the frame from distorting. The hatch/panel bolts will not line up with the nuts if distortion occurs. Ensure to remove temporary packers.
5. Frame the opening with steel studs or trimmers.
6. While the hatch/panel is open apply fire rated mastic sealant to any gaps between the access panel frame and the inside reveal of the opening.
7. Insert hatch/panel into frame ensuring the correct sides line up – refer to identification points on frame and hatch/panel. Engage all panel screws before fully tightening.

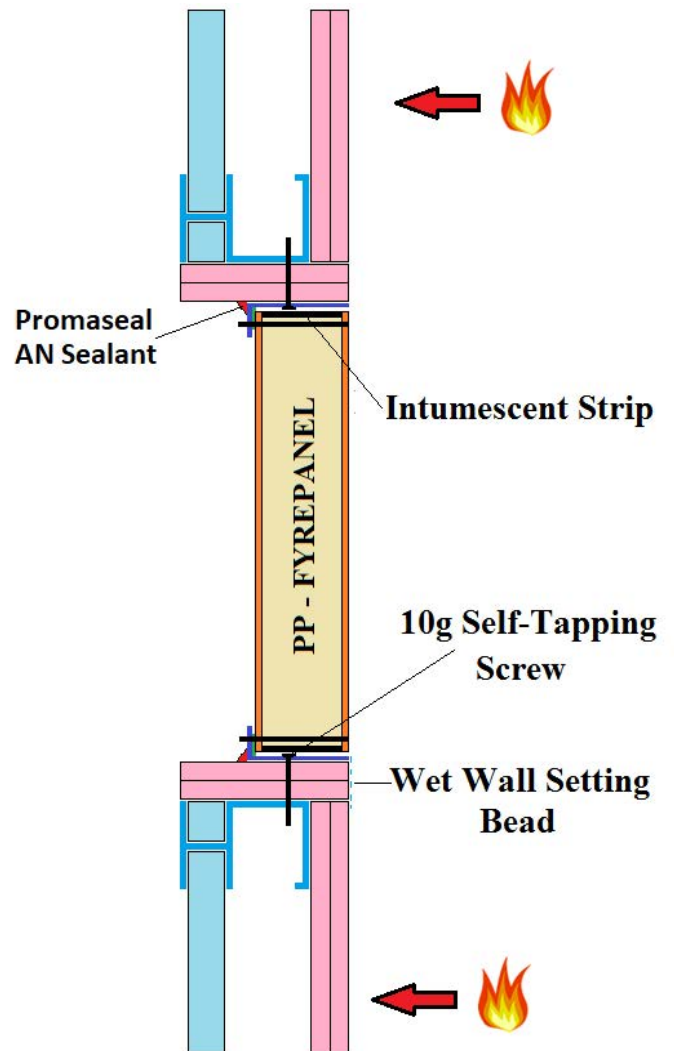

## ARCHITECTURAL DETAIL

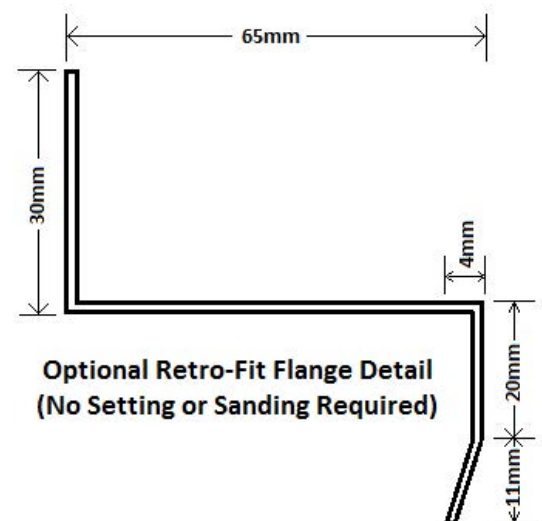
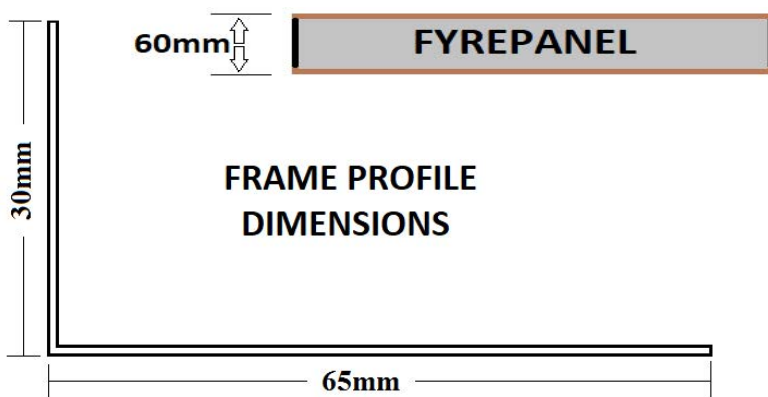

**NB: ALL FYREGUARD FIRE RATED ACCESS HATCHES ARE LABELED FOR EASE OF COMPLIANCE AND MAINTAINENCE INSPECTIONS. LABELING IS IN ACCORDANCE WITH FPA GOOD PRACTICE GUIDE AND AS4072.1**





## INSTALLATION INSTRUCTIONS

### 2 HOUR FIRE RATED SCREW FIXED ACCESS PANELS FOR MASONRY WALLS.

1. Mark out and cut opening in the ceiling.
2. Match access panel to the now trimmed and lined opening.
3. Open the hatch/panel and secure frame to the Masonry ceiling with M6 all steel masonry anchors, to all 4 sides of the hatch, using the predrilled holes provided.  
**NB:** Ensure the frame is temporarily packed out before tightening screws or anchors to prevent the frame from distorting. The hatch/panel bolts will not line up with the nuts if distortion occurs. Ensure to remove temporary packers.
4. While the hatch/panel is open apply fire rated mastic sealant to any gaps between the access panel frame and the inside reveal of the opening.
5. Insert hatch/panel into frame ensuring the correct sides line up – refer to identification points on frame and hatch/panel. Engage all panel screws before fully tightening.

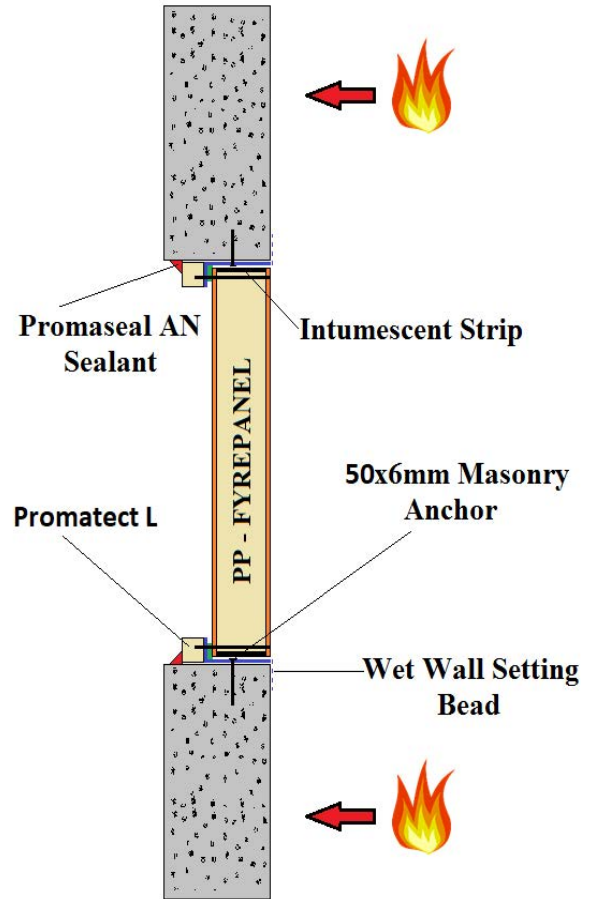

## ARCHITECTURAL DETAIL

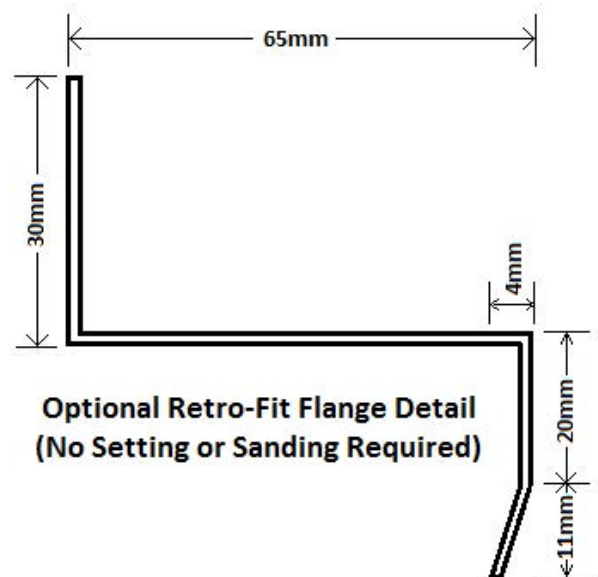
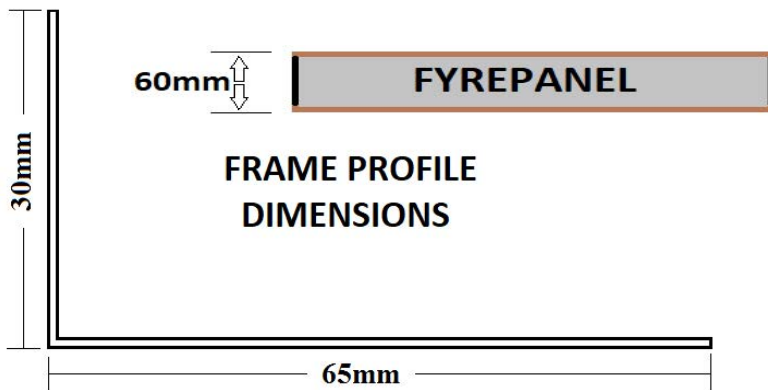

**NB: ALL FYREGUARD FIRE RATED ACCESS HATCHES ARE LABELED FOR EASE OF COMPLIANCE AND MAINTAINENCE INSPECTIONS. LABELING IS IN ACCORDANCE WITH FPA GOOD PRACTICE GUIDE AND AS4072.1**

**FYREGUARD PP - FYREPANEL FRL -/120/120**